



BERTAZZONI LISTA DE PRECIOS 2020
VÁLIDA A PARTIR DEL 1 DE ENERO





TERMINOS Y CONDICIONES

- Por ser nuestra línea de productos de importación, las listas de precios se manejan en dólares americanos y los artículos se liquidan en dolares americanos o pesos mexicanos al tipo de cambio que Artexa México S.A. de C.V. este manejando el día de pago esto para evitar que paguen al tipo de cambio que maneje el banco o diario oficial. Los precios no incluyen IVA.
- El flete en todos los casos es por cobrar, con excepción de las ciudades de Monterrey, México, Guadalajara y sus zonas metropolitanas; siempre y cuando la orden de compra sea de un mínimo de **\$500.00 USD + IVA.**
- No nos hacemos responsables por los riesgos del transporte, por lo que es necesario inspeccionar perfectamente la mercancía recibida, y en caso de ser necesaria, efectuar la reclamación con anotación en la guía y fotografías del daño. Solo en caso de que la mercancía recibida sea mayor a 10 piezas se otorgará un plazo de 48 horas para su reclamación.

PAGOS.

Para compras regulares de mercancía, el pago se realiza por anticipado a través de depósito bancario, es necesario contar con número de referencia para poder realizar el depósito el cual debe de ser consultado con su ejecutivo de cuenta.

<u>BANCOMER</u>	<u>SUCURSAL</u>	<u>CUENTA</u>	<u>CLABE ELECTRÓNICA</u>
BBVA MN	0813	0114193946	012580001141939466
BBVA (USD)	0813	0114193997	012580001141939974

- Una vez que se haya recibido la confirmación de sus pedidos por escrito, no se aceptan cambios o cancelaciones.
- Para ordenes de producto especiales o manterial SKU será necesario un anticipo del 50%.

DEVOLUCIONES

- Toda la devolución debe tener una autorización previa por escrito por parte de Artexa México S.A. de C.V.
- Únicamente se aceptan devoluciones de productos que manejamos para entrega inmediata.
- Es necesario que el producto a devolver se encuentre en perfecto estado así como su empaque, es decir, en condiciones de venderse como producto nuevo.
- Toda devolución causará un 20% de cargo.
- Toda devolución debe ser hecha con flete pagado por quien lo envía y asumir el riesgo de envío; si el producto presenta algún daño, no se aceptará y por consiguiente no se emitirá ninguna nota de crédito.
- Nos reservamos el derecho de aceptar o no una devolución.
- No se aceptan devoluciones después de 30 días de haber recibido el material.
- No se aceptan devoluciones de productos que no son SKU.

ESTUFAS 36" MASTER SERIES

BERTAZZONI	Código	Descripción	Color	Precio
	MAST365GASXE	36" Master Series range - Gas oven - 5 aluminum burners	Acero	\$3,870
	MAST365GASNEE	36" Master Series range - Gas oven - 5 aluminum burners	Negro	\$4,361
	MAST365GASBIE	36" Master Series range - Gas oven - 5 aluminum	Blanco	\$4,361
	Especificaciones			
	Worktop		Oven Cavity	
	Size	36 in	Oven configuration	single
Cooking zones	5	Oven fuel	gas	
Gas zones	5 Burners	Oven type	fan assisted gas	
Worktop type	gas	Oven broiler type	gas	
Knobs	solid metal	Oven functions	bake / broiler / convection bake	
Burner type	aluminium	Oven volume	5.9 ft ³	
Grates	cast iron	Oven convection system	dual horizontal fans	
Continuous grating	yes	Inner oven door	triple	
Thermocouple safety device	yes	Removable inner glass	yes	
One-hand ignition	yes	Cooling fan	yes	
Backguard	yes	Oven levels	7	
Simmer ring	yes	Door hinge	soft-motion	
Cookinf zones		Wire-shelves	4	
Dual wok	1300 BTU/h - 19 000 BTU/h (1)	Tray	1 enamelled	
Rapid	2500 BTU/h - 10 400 BTU/h (1)	Grill trivet for tray	yes	
Semi-rapid	1500 BTU/h - 5900 BTU/h (2)	Oven lights	double lateral	
Auxiliary	750 BTU/h - 3500 BTU/h (1)	Bottom		
		Legs	stainless steel	
		Technical specifications		
		Electrical requirements	120V 60 Hz - 300W 2.5 A	



ESTUFAS 36" PROFESSIONAL SERIES

BERTAZZONI	Código	Descripción	Color	Precio
	PROF366GASXT	36" Professional Series range - Gas oven - 6 brass burners	Acero	\$4,446
	PROF366GASNET	36" Professional Series range - Gas oven - 6 brass burners	Negro	\$5,946
	PROF366GASBIT	36" Professional Series range - Gas oven - 6 brass burners	Blanco	\$5,946
	PROF366GASGIT	36" Professional Series range - Gas oven - 6 brass burners	Amarillo	\$5,946
	PROF366DFSART	36" Professional Series range - Gas oven - 6 brass burners	Naranja	\$5,946
	PROF366GASROT	36" Professional Series range - Gas oven - 6 brass burners	Rojo	\$5,946
	PROF366GASXTLP	36" Professional Series range - Gas oven - 6 brass burners - LP version	Versión LP	\$4,446



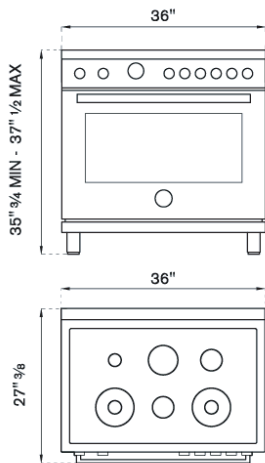

Especificaciones

Worktop		Oven Cavity	
Size	36 in	Oven broiler type	gas
Cooking zones	6	Oven functions	bake / broiler / convection bake
Gas zones	6 Burners	Oven volume	4.8 ft ³
Worktop type	gas	Oven convection system	dual horizontal fans
Knobs	metal coated	Inner oven door	triple
Burner type	brass	Removable inner glass	yes
Grates	cast iron	Cooling fan	yes
Continous grating	yes	Oven levels	7
Thermocouple safety device	yes	Door hinge	soft-close
One-hand ignition	yes	Sliding shelves	1 set of telescopic glides
Backguard	yes	Wire-shelves	2
Work adapter	yes	Tray	1 enamelled
Simmer ring	yes	Grill trivet for tray	yes
Cookinf zones		Oven lights	double lateral
Dual wok	1300 BTU/h - 19 000 BTU/h (2)	Bottom	
Rapid	2500 BTU/h - 10 400 BTU/h (1)	Legs	stainless steel
Semi-rapid	1500 BTU/h - 5900 BTU/h (2)	Technical specifications	
Auxiliary	750 BTU/h - 3500 BTU/h (1)	Electrical requirements	120V 60 Hz - 300W 2.5 A



ESTUFAS 90 CM

BERTAZZONI	Código	Descripción	Color	Precio
	PRO905GGVLCX	36" Master Series range - Gas oven - 5 aluminum burners	Acero	\$1,945
	Especificaciones			
	Worktop		Oven Cavity	
	Size	90 x 60 cm	Oven type	fan assisted gas with gas grill
	Cooking zones	5	Oven fuel	gas
	Worktop design	stainless steel squared	Oven functions	
	Worktop control	metal coated knobs	Oven volume	142 L
	Burner type	aluminium	Oven convection system	single or double
	Pan support	-	Inner oven door	triple
	Upstand / lid cover	upstand	Removable inner glass	-
Flame failure device	-	Cooling fan	optional	
One-hand ignition	-	Oven levels	5	
Work adapter	-	Door hinge	soft-motion / soft closing	
Cookinf zones		Wire-shelves	2-standard	
Front right	Auxiliary 0,48-1,00Kw	Tray	1-40 mm deep	
Back right	Rapid 1,05-3,00Kw	Oven lights	1or 2	
Center	Semi-Rapid (2) 0,60-1,75Kw	Bottom		
Front left	Dual Work 0,48-5,00Kw	Legs	stainless steel	
Back left	Rapid 1,05-3,00 Kw			

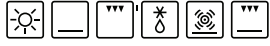
BERTAZZONI	Código	Descripción	Color	Precio
	MAS905GGVLCX	36" Master Series range - Gas oven - 5 aluminum burners	Acero	\$1,945
	Especificaciones			
	Worktop		Oven Cavity	
	Size	90 x 60 cm	Oven type	fan assisted gas with gas grill
	Cooking zones	5	Oven functions	
	Worktop design	stainless steel squared	Oven controls	thermometer
	Worktop control	soft touch knobs	Oven volume	142 L
	Burner type	aluminium	Oven convection system	single or double
	Pan support	cast iron	Inner oven door	triple
	Upstand / lid cover	upstand	Removable inner glass	-
Flame failure device	-	Cooling fan	optional	
One-hand ignition	-	Oven levels	5	
Work adapter	-	Door hinge	soft-motion	
Cookinf zones		Wire-shelves	2-standard	
Front right	Auxiliary 0,48-1,00Kw	Tray	1-40 mm deep	
Back right	Rapid 1,05-3,00Kw	Oven lights	1or 2	
Center	Semi-Rapid (2) 0,60-1,75Kw	Bottom		
Front left	Dual Work 0,48-5,00Kw	Legs	stainless steel	
Back left	Rapid 1,05-3,00 Kw			



ESTUFAS 48" MASTER SERIES

BERTAZZONI	Código	Descripción	Color	Precio
	MAST486GGASXE	48" Master Series range - Gas Oven - 6 aluminum	Acero	\$7,303
	MAST486GGASNEE	48" Master Series range - Gas Oven - 6 aluminum burners + griddle	Negro	\$7,892
	MAST486GGASBIE	48" Master Series range - Gas Oven - 6 aluminum	Blanco	\$7,892
	Especificaciones			
	Worktop		Oven Cavity	
	Size	48 in	Oven configuration	double
	Cooking zones	7	Oven fuel	gas
	Gas zones	6 Burners	Oven convection system	dual horizontal fans
	Griddle zones	electric	Main oven type	fan assisted gas
	Worktop type	electric / gas	Main oven broiler type	gas
	Knobs	solid metal	Main oven functions	bake / broiler / convection bake
	Burner type	aluminium	Main oven volume	4.8 ft ³
	Grates	cast iron	Auxiliary oven type	gas conventional
	Continous grating	yes	Auxiliary oven functions	bake
	Thermocouple safety device	yes	Auxiliary oven volume	2.4 ft ³
	One-hand ignition	yes	Inner oven door	triple
	Backguard	yes	Removable inner glass	yes
	Simmer ring	yes	Cooling fan	yes
	Cookinf zones		Oven levels	7
	Dual wok	1300 BTU/h - 19 000 BTU/h (2)	Door hinge	soft-motion
Rapid	2500 BTU/h - 10 400 BTU/h (1)	Wire-shelves	4	
Semi-rapid	1500 BTU/h - 5900 BTU/h (2)	Tray	1 enamelled	
Auxiliary	750 BTU/h - 3500 BTU/h (1)	Grill trivet for tray	yes	
Griddle power	1100 W	Oven lights	double lateral	
Griddle drip tray	yes	Bottom		
Griddle dual control	yes	Legs	stainless steel	
Technical specifications				
		Electrical requirements	120V 60 Hz - 1200W 10 A	

ESTUFAS 48" PROFESSIONAL SERIES

BERTAZZONI	Código	Descripción	Color	Precio
	PROF486GGASXT	48" Professional Series range - Gas Oven - 6 brass burners + griddle	Acero	\$7,780
	PROF486GGASNET	48" Professional Series range - Gas Oven - 6 brass burners + griddle	Negro	\$8,948
	PROF486GGASBIT	48" Professional Series range - Gas Oven - 6 brass burners + griddle	Blanco	\$8,948
	PROF486GGASGIT	48" Professional Series range - Gas Oven - 6 brass burners + griddle	Amarillo	\$8,948
	PROF486GGASART	48" Professional Series range - Gas Oven - 6 brass burners + griddle	Naranja	\$8,948
	PROF486GGASROT	48" Professional Series range - Gas Oven - 6 brass burners + griddle	Rojo	\$8,948
	PROF486GGASXTLP	48" Professional Series range - Gas Oven - 6 brass burners + griddle - LP version	Versión LP	\$7,780

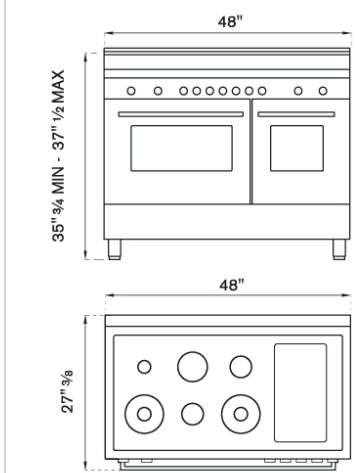

Especificaciones



Worktop		Oven Cavity	
Size	48 in	Oven configuration	double
Cooking zones	7	Oven fuel	gas
Gas zones	6 Burners	Main oven type	fan assisted gas
Griddle zones	electric	Main oven broiler type	gas
Worktop type	electric / gas	Main oven functions	bake / broiler / convection bake
Knobs	metal coated	Main oven volume	4.8 ft ³
Burner type	brass	Auxiliary oven type	gas conventional
Grates	cast iron	Auxiliary oven broiler type	gas
Continuous grating	yes	Auxiliary oven functions	bake
Thermocouple safety device	yes	Auxiliary oven volume	2.4 ft ³
One-hand ignition	yes	Inner oven door	triple
Backguard	yes	Removable inner glass	yes
Work adapter	yes	Cooling fan	yes
Simmer ring	yes	Oven levels	7
Cooking zones		Door hinge	soft-close
Dual wok	1300 BTU/h - 19 000 BTU/h (2)	Sliding shelves	2 sets of telescopic glides
Rapid	2500 BTU/h - 10 400 BTU/h (1)	Wire-shelves	5
Semi-rapid	1500 BTU/h - 5900 BTU/h (2)	Tray	1 enamelled
Auxiliary	750 BTU/h - 3500 BTU/h (1)	Grill trivet for tray	yes
Griddle power	1100 W	Oven lights	double lateral
Griddle drip tray	yes	Bottom	
Griddle dual control	yes	Legs	stainless steel
Technical specifications			
Electrical requirements		120V 60 Hz - 1200W 10 A	

ESTUFAS SERIE HERITAGE 36"

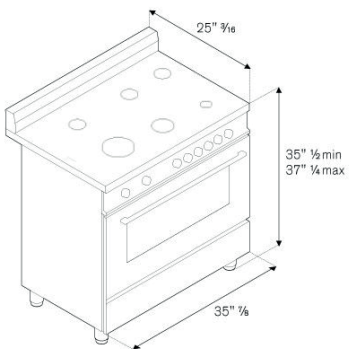
BERTAZZONI	Código	Descripción	Color	Precio
	HERT366GASNET	Estufa profesional estilo Heritage Negro mate de 36"	Negro	\$5,950
	HERT366GASAVT	Estufa profesional estilo Heritage Crema mate de 36"	Crema	\$5,950
	HERT366GASXT	Estufa profesional estilo Heritage Acero de 36"	Acero	\$5,950
Especificaciones				
Worktop		Oven Cavity		
Size	36 in	Oven configuration	single	
Cooking zones	6	Oven fuel	gas	
Gas zones	6 Burners	Oven type	fan assisted gas	
Worktop type	gas	Oven broiler type	gas	
Knobs	solid metal	Oven functions	bottom bake / broiler / defrosting / dehydrate / gas convection / oven light	
Burner type	brass	Oven volume	4.4 ft ³	
Grates	cast iron	Oven convection system	single	
Continuous grating	yes	Inner oven door	triple	
Thermocouple safety device	yes	Removable inner glass	yes	
One-hand ignition	yes	Oven controls	knobs	
Backguard	yes	Cooling fan	yes	
Work adapter	yes	Oven levels	5	
Simmer ring	yes	Door hinge	soft-motion	
Cooking zones		Sliding shelves	1 set of telescopic glides	
Dual wok	750 BTU/h - 18 000.00 BTU/h	Wire-shelves	2	
Rapid	2500 BTU/h - 11 000.00 BTU/h (1)	Tray	1 enamelled	
Semi-rapid	1500 BTU/h - 6500 BTU/h (3)	Grill trivet for tray	yes	
Auxiliary	750 BTU/h - 3400 BTU/h (1)	Oven lights	double	
Technical specifications		Bottom		
Electrical requirements	120 Vac - 60 Hz - 1.50 A	Storage compartment	flap	
		Legs	stainless steel	



CAMPANAS SERIE HERITAGE 36"

BERTAZZONI	Código	Descripción	Color	Precio
	KC36HERTAV	Campana pared profesional estilo Heritage 36"	Crema mate	\$840
	KC36HERTX	Campana pared profesional estilo Heritage 36"	Acero	\$840
	KC36HERTNE	Campana pared profesional estilo Heritage 36"	Negro	\$840
Especificaciones				
Worktop		Hood control	electronic with buttons	
Size	36 in	Filters type	baffle stainless steel	
Hood		Lights	2 halogen	
Hood type	wall mount	Max extraction power	600 CFM	
Motor	1	Sound Level	59 dB(A)	
Speed	3	Technical specifications		
Hood finishing	stainless steel and matt color	Electrical requirements	120 V - 60 Hz - 3.30 A	
Duct cover	included	Power rating	400 W	
Motor para campana HERITAGE 36"				
	K36HERTX	Motor 600 CFMS		\$1,504
				
				

ACCESORIOS OPCIONALES

Código	Descripción	Precio
DS1HERTGO	Decor Set 1- Range & Hood Kit : Gold Finish	\$1,439
DS1HERTPC	Decor Set 1- Range & Hood Kit : Polished Copper Finish	\$1,439
DS1HERTSB	Decor Set 1- Range & Hood Kit : Matt Satin Black Finish	\$1,439



ESTUFAS SERIE HERITAGE 48"

BERTAZZONI	Código	Descripción	Color	Precio
	HERT486GASNET	Estufa profesional estilo Heritage Negro mate de 48"	Negro	\$9,728
	HERT486GASAVT	Estufa profesional estilo Heritage Crema mate de 48"	Crema	\$9,728
	HERT486GASXT	Estufa profesional estilo Heritage Acero mate de 48"	Acero	\$9,728
	Especificaciones			
	Worktop		Oven Cavity	
	Size	48 in	Oven configuration	double
Cooking zones	7	Oven fuel	gas	
Gas zones	6 Burners	Oven type	fan assisted gas	
Griddle zones	electric	Oven broiler type	gas	
Worktop type	electric / gas	Oven functions	bottom bake / broiler / defrosting / dehydrate / gas convection / oven light	
Worktop design	stainless steel squared	Oven volume	3.6 ft ³	
Worktop controls	knobs	Auxiliary oven type	gas conventional	
Knobs	solid metal	Auxiliary oven broiler type	gas	
Burner type	brass	Auxiliary oven functions	bottom bake / oven light	
Grates	cast iron	Auxiliary oven volume	2.2 ft ³	
Continous grating	yes	Oven controls	knobs	
Thermocouple safety device	yes	Inner oven door	triple	
One-hand ignition	yes	Removable inner glass	yes	
Backguard	yes	Cooling fan	yes	
Work adapter	yes	Oven levels	5	
Simmer ring	yes	Door hinge	soft-motion	
Cookinf zones		Sliding shelves	2 sets of telescopic glides	
Dual wok	750 BTU/h - 18 000.00 BTU/h	Wire-shelves	2	
Rapid	2500 BTU/h - 11 000.00 BTU/h (1)	Tray	1 enamelled	
Semi-rapid	1500 BTU/h - 6500 BTU/h (3)	Grill trivet for tray	yes	
Auxiliary	750 BTU/h - 3400 BTU/h (1)	Oven lights	double diagonal	
Technical specifications		Bottom		
Electrical requirements	120 Vac - 60 Hz - 1.50 A	Storage compartment	flap	
		Legs	stainless steel	

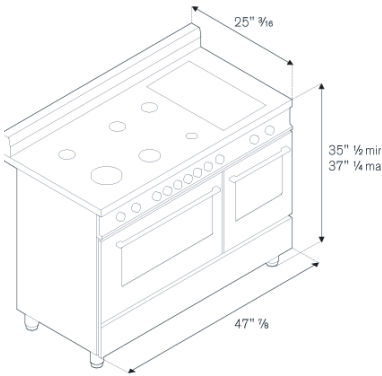

CAMPANAS SERIE HERITAGE 48"

BERTAZZONI	Código	Descripción	Color	Precio
	KC48HERTNE	Campana pared profesional estilo Heritage 48"	Negro mate	\$1,037
	KC48HERTAV	Campana pared profesional estilo Heritage 48"	Crema mate	\$1,037
	KC48HERTX	Campana pared profesional estilo Heritage 48"	Acero	\$1,037
Especificaciones				
Worktop		Hood control electronic with buttons		
Size	48 in	Filters type	baffle stainless steel	
Hood		Lights	2 halogen	
Hood type	wall mount	Max extraction power	600 CFM	
Motor	1	Sound Level	59 dB(A)	
Speed	3	Technical specifications		
Hood finishing	stainless steel and matt color	Electrical requirements	120 V - 60 Hz - 3.30 A	
Duct cover	included	Power rating	400 W	
Motor para campana HERITAGE 36"				
	K48HERTX	Motor 600 CFMS		\$1,635

ACCESORIOS OPCIONALES

Código	Descripción	Precio
DS1HERTGO	Decor Set 1- Range & Hood Kit : Gold Finish	\$1,439
DS1HERTPC	Decor Set 1- Range & Hood Kit : Polished Copper Finish	\$1,439
DS1HERTSB	Decor Set 1- Range & Hood Kit : Matt Satin Black Finish	\$1,439

PARRILLAS PROFESIONALES - GAS

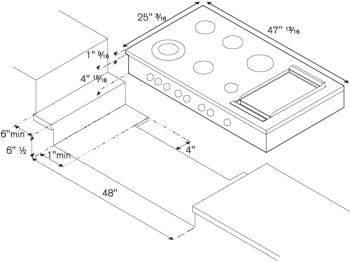
BERTAZZONI	Código	Descripción	Color	Precio
 	CB486G00X	48" Rangetop 6 Brass Burners + Griddle	Acero	\$3,028
	Especificaciones			
Worktop		Cooking zones		
Size	48 in	Dual wok	750 BTU/h - 18 000.00 BTU/h	
Cooking zones	7	Rapid	2500 BTU/h - 11 000.00 BTU/h (1)	
Gas zones	6	Semi-rapid	1500 BTU/h - 6500 BTU/h (3)	
Griddle zones	electric	Auxiliary	750 BTU/h - 3400 BTU/h (1)	
Worktop type	electric /gas	Griddle power	1100 W	
Worktop design	stainless steel squared	Griddle drip tray	yes	
Worktop controls	knobs	Griddle dual control	yes	
Knobs	solid metal	Technical specifications		
Burner type	brass	Electrical requirements	120 V - 60 Hz - 10 A	
Grates	cast iron	Power rating	1100 W	
Continous grating	yes			
Thermocouple safety device	yes			
One-hand ignition	yes			
Backguard	yes			
Wok adapter	yes			
Simmer ring	yes			

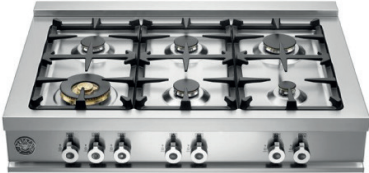
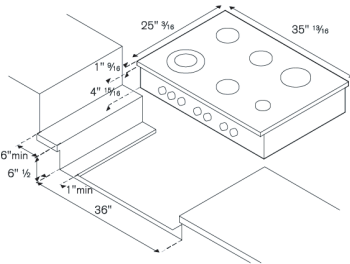
BERTAZZONI	Código	Descripción	Color	Precio
 	CB36600X	36" Rangetop 6 Brass Burners	Acero	\$1,987
	Especificaciones			
Worktop		Cooking zones		
Size	36 in	Dual wok	750 BTU/h - 18 000.00 BTU/h	
Cooking zones	6	Rapid	2500 BTU/h - 11 000.00 BTU/h (1)	
Gas zones	6	Semi-rapid	1500 BTU/h - 6500 BTU/h (3)	
Worktop type	gas	Auxiliary	750 BTU/h - 3400 BTU/h (1)	
Worktop design	stainless steel squared	Technical specifications		
Worktop controls	knobs	Electrical requirements	120 V - 60 Hz - 1 A	
Knobs	solid metal	Power rating	1W	
Burner type	brass			
Grates	cast iron			
Continous grating	yes			
Thermocouple safety device	yes			
One-hand ignition	yes			
Backguard	yes			
Wok adapter	yes			
Simmer ring	yes			

PARRILLAS ENCIMERAS DE GAS BERTAZZONI

BERTAZZONI	Código	Descripción	Color	Precio	
	P905Cprox	90cm Gas on steel Cooktop, 5 Brass Burners	Acero	\$912	
	Especificaciones				
	Worktop		Cooking zones		
	Size	90 cm	Front right	1 auxiliary 0.48 kW - 1.00 kW	
	Worktop surface	stainless steel	Back right	1 rapid 1.05 kW - 3.00 kW	
	Layout	5 burners	Center	1 wok dual 0.48 kW - 5.00 kW	
	Worktop controls	knobs	Front left	1 semi-rapid 0.60 kW - 1.75 kW	
	Knobs	metal	Back left	1 semi-rapid 0.60 kW - 1.75 kW	
	Pan supports	cast iron	Technical specifications		
	Burner type	brass	Electrical requirements	220/240, 50/60 Hz, 1A, 1W	
	Work burner	5 kW dual			
	Flame failure device	-			
	One-hand ignition	-			
	Standard accessories	-			

PARRILLAS ELÉCTRICAS / INDUCCIÓN

BERTAZZONI	Código	Descripción	Color	Precio	
	P906IM3G5NE	90cm induction hob, 3 multi zone	Black Glass	\$2,368	
	Especificaciones				
	Worktop		Cooking zones		
	Size	90cm	Central	380 x 240mm/ 3,3 - 3,7 kW (booster)	
	User interface	LED 7 segment	Multizone left	380 x 240mm/ 3,3 - 3,7 kW (booster)	
	Controls	slim slider	Multizone right	380 x 240mm/ 3,3 - 3,7 kW (booster)	
	Cooking zones	6	Technical specifications		
	Bridge zones	FlexiPlus	Electrical requirements	220/240 V, 50/60 Hz	
	Multi zone	3 zones	Power	11 kW	
	Power levels	1-15			
	Booster	all zones			

ACCESORIO ESTUFAS / PARRILLAS

BERTAZZONI	Código	Descripción	Color	Precio
	901401	Plancha para 2 quemadores	Acero	\$424
	Especificaciones			
	Size	276x512 cm		
	Type	Accesorio de plancha de acero inoxidable para dos quemadores de estufa.		
Finishing	stainless steel			

HORNOS CONVECCIÓN 30"

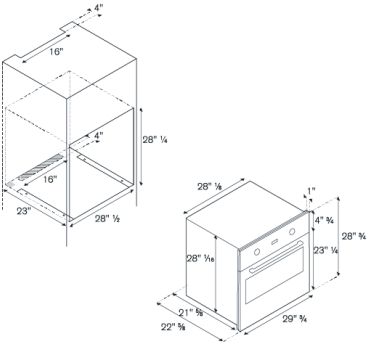
BERTAZZONI	Código	Descripción	Color	Precio																																																											
 	PROFS30XT	30" Single Convection Oven Top Version	Acero	\$4,099																																																											
	<p align="center">Especificaciones</p> <table border="1"> <thead> <tr> <th colspan="2">Worktop</th> <th>Cavity finishing</th> <th>pyrolytic grey enamel</th> </tr> </thead> <tbody> <tr> <td>Size</td> <td>30 in</td> <td>Oven handle</td> <td>metal</td> </tr> <tr> <td>Oven configuration</td> <td>single</td> <td>Cooling fan</td> <td>yes</td> </tr> <tr> <td>Oven fuel</td> <td>electric</td> <td>Oven levels</td> <td>7</td> </tr> <tr> <td>Oven type</td> <td>self-clean</td> <td>Timer</td> <td>touch digital programmer</td> </tr> <tr> <td>Oven broiler type</td> <td>electric</td> <td>Auto cooking modes</td> <td>33 preset / with assistant</td> </tr> <tr> <td>Oven functions</td> <td>bake / broiler / convection/ convection bake / convec- tion broiler / defrosting / dehydrate / proofing / pyrolytic self clean / turbo / warming</td> <td>Door hinge</td> <td>soft-motion</td> </tr> <tr> <td></td> <td></td> <td>Sliding shelves</td> <td>1 full extension</td> </tr> <tr> <td></td> <td></td> <td>Wire-shelves</td> <td>2 heavy gauge chromed</td> </tr> <tr> <td></td> <td></td> <td>Tray</td> <td>1 enamelled</td> </tr> <tr> <td>Overall volume</td> <td>4.10 ft³</td> <td>Grill trivet for tray</td> <td>yes</td> </tr> <tr> <td>Oven convection system</td> <td>dual diagonal with heating element</td> <td>Oven lights</td> <td>double</td> </tr> <tr> <td>Oven controls</td> <td>knobs / touch LCD hi res display</td> <td colspan="2">Technical specifications</td> </tr> <tr> <td>Inner oven door</td> <td>quaduple</td> <td>Electrical requirements</td> <td>120/240 Vac - 60 Hz - 30 A</td> </tr> <tr> <td>Removable inner glass</td> <td>yes</td> <td>Power rating</td> <td>5500 W</td> </tr> </tbody> </table>				Worktop		Cavity finishing	pyrolytic grey enamel	Size	30 in	Oven handle	metal	Oven configuration	single	Cooling fan	yes	Oven fuel	electric	Oven levels	7	Oven type	self-clean	Timer	touch digital programmer	Oven broiler type	electric	Auto cooking modes	33 preset / with assistant	Oven functions	bake / broiler / convection/ convection bake / convec- tion broiler / defrosting / dehydrate / proofing / pyrolytic self clean / turbo / warming	Door hinge	soft-motion			Sliding shelves	1 full extension			Wire-shelves	2 heavy gauge chromed			Tray	1 enamelled	Overall volume	4.10 ft ³	Grill trivet for tray	yes	Oven convection system	dual diagonal with heating element	Oven lights	double	Oven controls	knobs / touch LCD hi res display	Technical specifications		Inner oven door	quaduple	Electrical requirements	120/240 Vac - 60 Hz - 30 A	Removable inner glass	yes	Power rating
Worktop		Cavity finishing	pyrolytic grey enamel																																																												
Size	30 in	Oven handle	metal																																																												
Oven configuration	single	Cooling fan	yes																																																												
Oven fuel	electric	Oven levels	7																																																												
Oven type	self-clean	Timer	touch digital programmer																																																												
Oven broiler type	electric	Auto cooking modes	33 preset / with assistant																																																												
Oven functions	bake / broiler / convection/ convection bake / convec- tion broiler / defrosting / dehydrate / proofing / pyrolytic self clean / turbo / warming	Door hinge	soft-motion																																																												
		Sliding shelves	1 full extension																																																												
		Wire-shelves	2 heavy gauge chromed																																																												
		Tray	1 enamelled																																																												
Overall volume	4.10 ft ³	Grill trivet for tray	yes																																																												
Oven convection system	dual diagonal with heating element	Oven lights	double																																																												
Oven controls	knobs / touch LCD hi res display	Technical specifications																																																													
Inner oven door	quaduple	Electrical requirements	120/240 Vac - 60 Hz - 30 A																																																												
Removable inner glass	yes	Power rating	5500 W																																																												

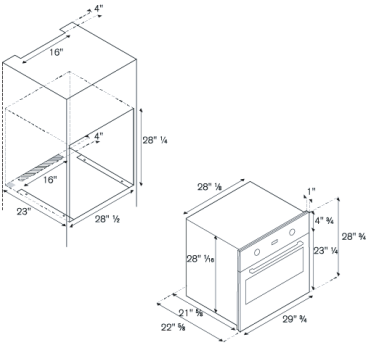
BERTAZZONI	Código	Descripción	Color	Precio																																																															
 	PROFS30XV	30" Single Convection Oven Value Version	Acero	\$3,058																																																															
	<p align="center">Especificaciones</p> <table border="1"> <thead> <tr> <th colspan="2">Worktop</th> <th>Oven handle</th> <th>metal</th> </tr> </thead> <tbody> <tr> <td>Size</td> <td>30 in</td> <td>Cooling fan</td> <td>yes</td> </tr> <tr> <td>Oven configuration</td> <td>single</td> <td>Oven levels</td> <td>7</td> </tr> <tr> <td>Oven fuel</td> <td>electric</td> <td>Timer</td> <td>touch digital programmer</td> </tr> <tr> <td>Oven type</td> <td>self-clean</td> <td>Door hinge</td> <td>soft-motion</td> </tr> <tr> <td>Oven broiler type</td> <td>electric</td> <td>Wire-shelves</td> <td>2 heavy gauge chromed</td> </tr> <tr> <td>Oven functions</td> <td>bake / broiler / convection/ convection bake / convec- tion broiler / defrosting / dehydrate / proofing / pyrolytic self clean / turbo / warming</td> <td>Tray</td> <td>1 enamelled</td> </tr> <tr> <td></td> <td></td> <td>Grill trivet for tray</td> <td>yes</td> </tr> <tr> <td></td> <td></td> <td>Oven lights</td> <td>single</td> </tr> <tr> <td></td> <td></td> <td colspan="2">Technical specifications</td> </tr> <tr> <td>Overall volume</td> <td>4.10 ft³</td> <td>Electrical requirements</td> <td>120/240 V - 60 Hz - 30 A</td> </tr> <tr> <td>Oven convection system</td> <td>dual diagonal with heating element</td> <td>Power rating</td> <td>5500 W</td> </tr> <tr> <td>Oven controls</td> <td>knobs / touch LED display</td> <td></td> <td></td> </tr> <tr> <td>Inner oven door</td> <td>quaduple</td> <td></td> <td></td> </tr> <tr> <td>Removable inner glass</td> <td>yes</td> <td></td> <td></td> </tr> <tr> <td>Cavity finishing</td> <td>pyrolytic grey enamel</td> <td></td> <td></td> </tr> </tbody> </table>				Worktop		Oven handle	metal	Size	30 in	Cooling fan	yes	Oven configuration	single	Oven levels	7	Oven fuel	electric	Timer	touch digital programmer	Oven type	self-clean	Door hinge	soft-motion	Oven broiler type	electric	Wire-shelves	2 heavy gauge chromed	Oven functions	bake / broiler / convection/ convection bake / convec- tion broiler / defrosting / dehydrate / proofing / pyrolytic self clean / turbo / warming	Tray	1 enamelled			Grill trivet for tray	yes			Oven lights	single			Technical specifications		Overall volume	4.10 ft ³	Electrical requirements	120/240 V - 60 Hz - 30 A	Oven convection system	dual diagonal with heating element	Power rating	5500 W	Oven controls	knobs / touch LED display			Inner oven door	quaduple			Removable inner glass	yes			Cavity finishing	pyrolytic grey enamel	
Worktop		Oven handle	metal																																																																
Size	30 in	Cooling fan	yes																																																																
Oven configuration	single	Oven levels	7																																																																
Oven fuel	electric	Timer	touch digital programmer																																																																
Oven type	self-clean	Door hinge	soft-motion																																																																
Oven broiler type	electric	Wire-shelves	2 heavy gauge chromed																																																																
Oven functions	bake / broiler / convection/ convection bake / convec- tion broiler / defrosting / dehydrate / proofing / pyrolytic self clean / turbo / warming	Tray	1 enamelled																																																																
		Grill trivet for tray	yes																																																																
		Oven lights	single																																																																
		Technical specifications																																																																	
Overall volume	4.10 ft ³	Electrical requirements	120/240 V - 60 Hz - 30 A																																																																
Oven convection system	dual diagonal with heating element	Power rating	5500 W																																																																
Oven controls	knobs / touch LED display																																																																		
Inner oven door	quaduple																																																																		
Removable inner glass	yes																																																																		
Cavity finishing	pyrolytic grey enamel																																																																		

HORNOS 60 CM

BERTAZZONI	Código	Descripción	Color	Precio
	F609PROESX	60cm Single Convection Oven	Acero	\$1,222
	Especificaciones			
Worktop		Cleaning	easy to clean enamel	
Size	60cm	Wire-shelves	2	
Oven fuel	electric	Tray	1 baking tray	
Overall volume	76L	Door hinge	soft-opening	
Oven controls	knobs and LED display	Oven door glass	2	
Knobs	metal	Oven lights	1 rear	
Handle	metal	Stainless steel finishing	standard	
Cavity finishing	Pyro enamel light grey	Technical specifications		
Oven functions		Electrical requirements	220/240v, 50/60 Hz, 2700W	
		Energy rating	A	

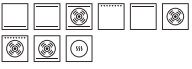
BERTAZZONI	Código	Descripción	Color	Precio
	F609PROEKX	60cm electric built-in oven	Acero	\$1,064
	Especificaciones			
Worktop		Cleaning	easy to clean enamel	
Size	60cm	Wire-shelves	2	
Oven fuel	electric	Tray	1 baking tray	
Overall volume	76L	Door hinge	soft-opening	
Oven controls	knobs	Oven door glass	2	
Knobs	metal	Oven lights	1 rear	
Handle	metal	Stainless steel finishing	standard	
Cavity finishing	Pyro enamel light grey	Technical specifications		
Oven functions		Electrical requirements	220/240v, 50/60 Hz, 2700W	
		Energy rating	A	

HORNO VAPOR

BERTAZZONI	Código	Descripción	Color	Precio
	PROCS30X	30" Convection Steam Oven	Acero	\$2,370
	Especificaciones			
	Worktop		Removable inner glass	yes
	Size	30 in	Cavity finishing	stainless steel
	Oven functions	broiler / convection / convection broiler / steam / steam convection / warming	Oven levels	2
			Tray	1 stainless steel 40 mm deep
			Grill trivet for tray	yes
	Overall volume	1.34 ft ³	Oven lights	single
	Oven convection system	single with ring heating element	Technical specifications	
	Inner oven door	double	Electrical requirements	208/240 V - 60 Hz - 15 A
		Power rating	3300 W	

SPEED OVEN / COMBI / MICROONDAS

BERTAZZONI	Código	Descripción	Color	Precio
	PROSO30X	30" Convection Speed Oven	Acero	\$2,324
	Especificaciones			
	Worktop		Removable inner glass	yes
	Size	30 in	Cavity finishing	stainless steel
	Oven functions	broiler / convection / microwave / convection broiler / microwave with broiler	Oven levels	2
			Tray	1 glass
			Grill trivet for tray	yes
	Overall volume	1.34 ft ³	Oven lights	single
	Oven convection system	single with ring heating element	Technical specifications	
	Auto cooking modes	5 preset	Electrical requirements	208/240 V - 60 Hz - 15 A
Inner oven door	double	Power rating	3300 W	

BERTAZZONI	Código	Descripción	Color	Precio
	F457PROMWTX	60x45cm Combi microwave oven	Acero	\$2,053
	Especificaciones			
	Worktop		Cavity finishing	stainless steel
	Size	60 x 45cm	Oven door frame	O shape
	Oven type	combi-microwave	Oven levels	2
	Overall volume	38L	Wire shelves	1
	Oven controls	knobs and touch TFT display	Trays	1 glass
	Knobs	metal	Oven lights	1
	Auto cooking modes	15	Door hinges	soft closing
	Oven handle	metal	Stainless steel finishing	anti-fingerprint
Oven functions		Technical specifications		
Special functions	defrosting time, defrosting weight	Electrical requirements	120/240 Vac - 60 Hz - 30 A	
Power control	electric	Power rating	5500 W	

MICROONDAS

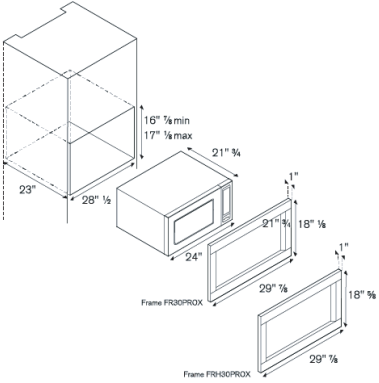
BERTAZZONI	Código	Descripción	Color	Precio
 	MO30STANE	Microwave Oven	Acero	\$789
	Especificaciones			
Worktop		Turnspit	1 Ø 16	
Technical specifications		Electrical requirements	120 V - 60 Hz - 10 A	
Size	30 in	Power rating	1100 W	
Overall volume	2.00 ft ³	Microwave power levels	10 Levels	
Cavity finishing	Enameled white	Preset cooking mode functions	yes	
Multiple sequence cooking	4	Sensor reheat, defrost, cook	yes	
Child lock	yes	Clock/Timer	yes	
		Cook time function	yes	

TRIMS

BERTAZZONI	Código	Descripción	Color	Precio
	FR30PROX	30" Built-in Trim for MO30STANE	Acero	\$233
	Especificaciones			
Size	30 in			
Type	Built-in Installation of MO30STANE 24" Microwave			
Finishing	stainless steel			

CAJONES CALIENTE

BERTAZZONI	Código	Descripción	Color	Precio
	PROWD30X	30" Convection Warming Drawer	Acero	\$1,154
	Especificaciones			
	Worktop			
	Size	30 IN		
	Design	stainless steel		
	Equipment	thermostat light on/off		
	Technical specifications			
	Electrical requirements	120 V - 60 Hz - 10 A		
	Power rating	400 W		

BERTAZZONI	Código	Descripción	Color	Precio
	WD60PROX	60x15cm Warming Drawer	Acero	\$807
	Especificaciones			
	Worktop			
	Size	60x15cm		
	Cavity capacity	25KG		
	Controls	push/pull with soft motion operation		
	Temprature range	30-85° C		
	Equipment	inner rubber matt, thermostat light on/off		
	Colours available			
	stainless steel, matt black			
Technical specifications				
Electrical requirements	220/240 V, 50/60 Hz - 400W			

REFRIGERADORES

BERTAZZONI	Código	Descripción	Color	Precio
	REF36X	36" French door refrigerator - Freestanding - Stainless	Acero	\$3,960

Especificaciones

Worktop			
Size	36 in	Foldable glass shelf	yes
Type	Freestanding	Drawer freezer	2
Finishing	Stainless steel no fingerprint	Gallon Balcony	yes
Interface	Interior LED touch-interface	Cooling System	Total no frost
Illumination	2 LED on sides and top part of the cabinet	Superfreezer	yes
Open door alarm	yes	Counter depth	yes
Icemaker	yes	Certification	CSA
Temperature controlled crisper	yes	Door storage compartment	2 Stationary 4 Gallon-sized and height adjustable
Shelves	2 Stationary / 4 Height-adjustable	Refrigerator capacity	15.00 ft ³
		Freezer capacity	6.00 ft ³
		Technical specifications	
		Electrical requirements	115 V - 60 Hz - 2.70 A

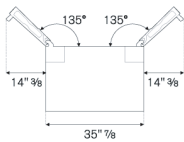
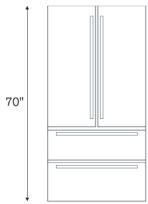

ELEGIR SET DE JALADERAS

PROHK36REF	Professional Series handles	\$229
MASHK36REF	Master Series handles	\$229
HERKH36REF	Heritage Series handles	\$490



PROHK36REF



MASHK36REF



HERKH36REF



REFRIGERADORES

BERTAZZONI	Código	Descripción	Color	Precio	
	REF24PR	24" Bottom Mount integrated panel ready	White	\$1,698	
	Especificaciones				
	Worktop		Total volume	8.8 cut.ft.	
	Size	24 in	Refrigerator	6.4 cut.ft.	
	Type	Freestanding	Freezer	2.4 cut.ft.	
	Finishing	White	Technical specifications		
	Interface	Touch control on interior side wall	Voltage, Frequency, Amps	115V/60Hz - 0.8 Amps 85W	
	Illumination	LED on top	Power Connection	125V 3- prong plug 67"cord	
	Door storage	3 bins	Certification	UL / CEC / DOE	
	Icemaker	N/A	Energy star	Yes	
Refrigerator crisper	1 full-width with slider to store fruit avegetables	Warranty	2 years parts & labor		
Shelves	3 full-width	Packaging dimitions and weight	W 22.8" H 74" D 23"		
Added storage space	Full-width and depth storage space unde crisperr	Net Weight	157.63 lbs		
Drawer freezer	3	Gross Weight	144.4 lbs		

SIDE

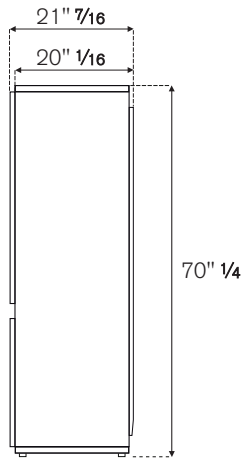

FRONT

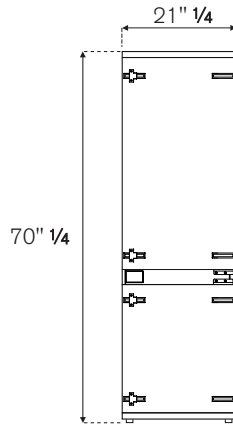

TOP

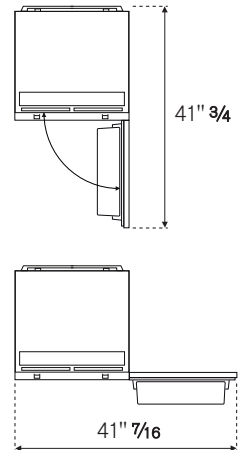

****MODELO DISPONIBLE JUNIO 2020**



*Cañón Grande 7720,
Col. La Estanzuela
Monterrey, N.L. 64984*

T. (81)8625 5000
info@artexa.com

**Artexa Experience
& Design Center Mexico City**
*Homero 1433 Mezzanine
Col. Polanco II Secc.,
Delegación Miguel Hidalgo,
Ciudad de México 11540
citas@artexa.com*

Oficina de proyectos
*Dakota 204, 3er piso, desp. 302
Col. Napoles
Ciudad de México 03810*
T. (55)5256 5373