

DEPON

COLLECTIONS 2021



DEDON

TERMS & CONDITIONS

TERMS AND CONDITIONS

AREAS OF USAGE

Certain products are recommended for use exclusively in the residential sector. For use in public areas such as public educational institutions, restaurants or meeting places, where the furniture may be exposed to particularly high stress, special requirements and standards apply. Please always ask about the suitability of your desired DEDON products for public places before placing an order. All products intended for contract use are marked with a contract icon.



PRICES

Please note that, from 2021 onwards, our price list includes recommended retail prices both including and excluding VAT. Our partners' individual purchase prices are based on the recommended price list and are linked to the terms of the valid partner agreement concluded between DEDON and the individual partner. Please contact your DEDON sales representative for any further price information.

RRP/UVP/PVPR =	
2.600 €	2.185 €
RRP incl. VAT	RRP excl. VAT

AVAILABILITY

From 2021 onwards, you will be informed through our "Quick Ship" system of items that have high inventory (this refers to items excluding cushions). For contract orders, each project will be processed on a case-by-case basis, with lead times confirmed separately. Please contact your DEDON sales representative for any further information about product availability.



ASSEMBLY

Most DEDON tables, chairs and loungers require assembly.



DISCLAIMER

Although the information in this price list is presented in good faith and believed to be correct at the time of printing, DEDON makes no representations or warranties as to the completeness or accuracy of the information. DEDON accepts no liability for any errors or omissions. DEDON reserves the right to change specifications and descriptions in light of technical developments and the availability of materials. We are not liable for variations in color, weight or dimensions, since such variations are typical of handmade furniture. Some items and fabrics that are featured in mood images may be discontinued.

WEIGHT / VOLUME

The stated weight of a furniture item does not include cushions and may vary according to fiber options. The stated volume does not include packaging.

ALLGEMEINE GESCHÄFTSBEDINGUNGEN

EINSATZBEREICHE

Einige Produkte sind nur für den privaten Wohnbereich gedacht. Für den Einsatz in öffentlichen Bereichen, z.B. in Bildungseinrichtungen, Restaurants oder an Versammlungs-orten, wo die Möbel besonders stark belastet werden, gelten bestimmte Anforderungen und Standards. Erkundigen Sie sich daher bitte vor jeder Bestellung, ob die DEDON-Produkte Ihrer Wahl für die Verwendung an öffentlichen Orten geeignet sind. Alle Produkte, die für eine gewerbliche Nutzung gedacht sind, sind mit dem Symbol "C" (Contract) gekennzeichnet.



PREISE

Bitte beachten Sie, dass wir ab 2021 in unseren Preislisten unverbindliche Preisempfehlungen sowohl mit als auch ohne MwSt. angeben. Die individuellen Einkaufspreise unserer Partner basieren auf der Liste der unverbindlichen Preisempfehlungen und Bedingungen des jeweils geltenden Partnervertrags zwischen DEDON und dem Partnerunternehmen. Bitte wenden Sie sich für weitere Informationen hinsichtlich der Preise an Ihren zuständigen DEDON-Ansprechpartner.

RRP/UVP/PVPR =	
2.600 €	2.185 €
UVP inkl. MwSt.	UVP exkl. MwSt.

VERFÜGBARKEIT

Ab 2021 informiert Sie unser "Quick Ship" System, welche Produkte einen hohen Lagerbestand haben (gilt nicht für Kissen). Bei Fertigungsaufträgen wird jedes Projekt einzeln bearbeitet und die jeweilige Bearbeitungszeit wird gesondert bestätigt. Bitte wenden Sie sich für weitere Informationen zum Thema Produktverfügbarkeit an Ihren zuständigen DEDON-Ansprechpartner.



MONTAGE

Die meisten Tische, Stühle und Liegen von DEDON müssen zusammengebaut werden.



HAFTUNGS-AUSSCHLUSS

Die Angaben in der Preisliste wurden nach bestem Wissen erstellt. Wir gehen davon aus, dass sie zum Druckzeitpunkt korrekt sind. Dennoch macht DEDON keine Zusicherungen und übernimmt keine Garantie für ihre Vollständigkeit und Richtigkeit. DEDON haftet nicht für Fehler oder fehlende Angaben. DEDON behält sich das Recht vor, Eigenschaften und Beschreibungen aufgrund technischer Entwicklungen bzw. der Verfügbarkeit von Materialien zu ändern. Für Farben, Maße und Gewichte können wir keine Haftung übernehmen, da Abweichungen bedingt durch Handarbeit möglich sind. Manche Produkte und Stoffe, die in unseren Abbildungen zu sehen sind, sind ggf. nicht mehr verfügbar.

GEWICHT / VOLUMEN

Die Angaben zu dem Gewicht eines Möbelstücks verstehen sich exklusive Kissen und können aufgrund von unterschiedlichen Faserausführungen leicht variieren. Das angegebene Volumen gilt stets ohne Verpackung.

TERMINOS Y CONDICIONES

ÁMBITOS DE USO

Se recomienda el uso de ciertos productos exclusivamente en el ámbito residencial. Para su utilización en espacios públicos, como instituciones educativas públicas, restaurantes o lugares de reunión, en los que el mobiliario puede estar expuesto a un nivel de uso particularmente elevado, se aplican requisitos y normas especiales. Por favor, siempre pregunte sobre la idoneidad de los productos DEDON para lugares públicos antes de hacer un pedido. Todos los productos adecuados para utilización en contract están señalados con el icono „C“.



PRECIOS

Tenga en cuenta que, a partir de 2021, nuestra lista de precios incluye los precios de venta al público recomendados con y sin IVA. Los precios de compra individuales de nuestros distribuidores se basan en la lista de precios recomendados y están vinculados a los términos del acuerdo vigente acordado entre DEDON y el distribuidor en cuestión. Por favor, contacte con su representante comercial de DEDON para cualquier información adicional sobre el precio.

RRP/UVP/PVPR =	
2.600 €	2.185 €
PVPR con IVA	PVPR sin IVA

DISPONIBILIDAD

A partir de 2021, a través de nuestro sistema de "Quick Ship" le informaremos de los artículos que están en stock y disponibles (esto vale para todos los artículos excepto los cojines). En el caso de los pedidos contract, cada proyecto se gestionará de forma individualizada, siendo los plazos de entrega confirmados en cada caso. Por favor, contacte con su representante comercial de DEDON para cualquier información adicional sobre la disponibilidad del producto.



MONTAJE

La mayoría de mesas, sillas y tumbonas de DEDON requieren montaje.



DESCARGO DE RESPONSABILIDAD

Aunque la información de esta lista de precios se presenta de buena fe y se cree que es correcta en el momento de su impresión, DEDON no efectúa manifestación ni declaración de garantía alguna en cuanto a la integridad o exactitud de la información. DEDON no se hace responsable de ningún error u omisión. DEDON se reserva el derecho de modificar las especificaciones y descripciones a expensas de mejoras técnicas y la disponibilidad de los materiales. No nos hacemos responsables de ninguna discordancia en cuanto al color, peso o tamaño, ya que las variaciones de este tipo son habituales en muebles fabricados a mano. Algunos artículos y tejidos mostrados en las fotos pueden ser discontinuados.

PESO / VOLUMEN

El peso publicado de un artículo de muebles no incluye los cojines y puede variar de acuerdo a las fibras seleccionadas. El volumen indicado no incluye el embalaje.

CONTENTS



RESIDENTIAL COLLECTIONS Page 10 - 193 - including individual contract items

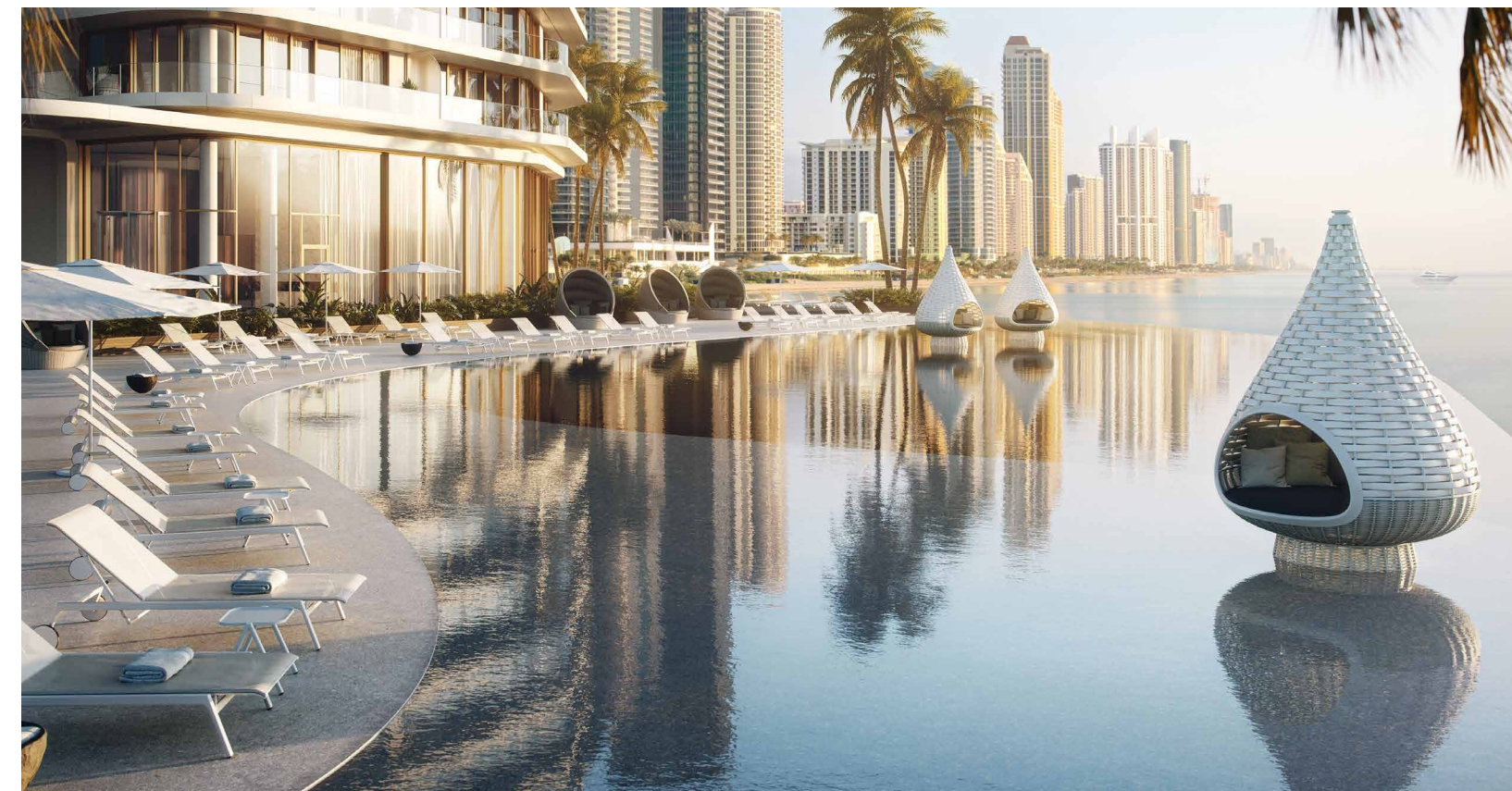

CONTRACT COLLECTIONS Page 194 - 211

CONTENTS

DINING CHAIRS



BARSTOOLS



LOUNGE CHAIRS



CONTENTS

LOUNGING



CONTENTS

TABLES



SIDE TABLES

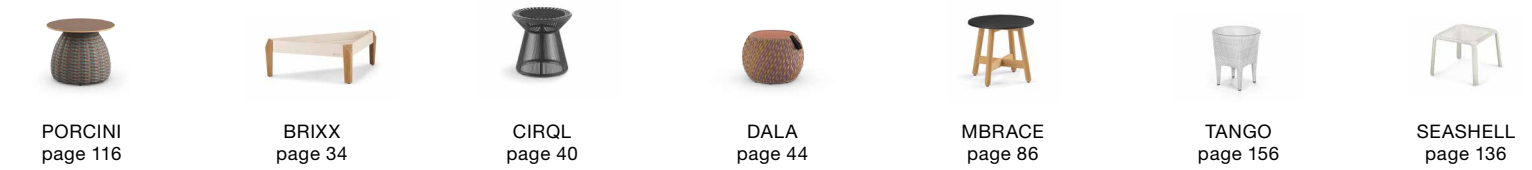

CONTENTS

BEACH CHAIRS



ACCESSORIES



ICONICS

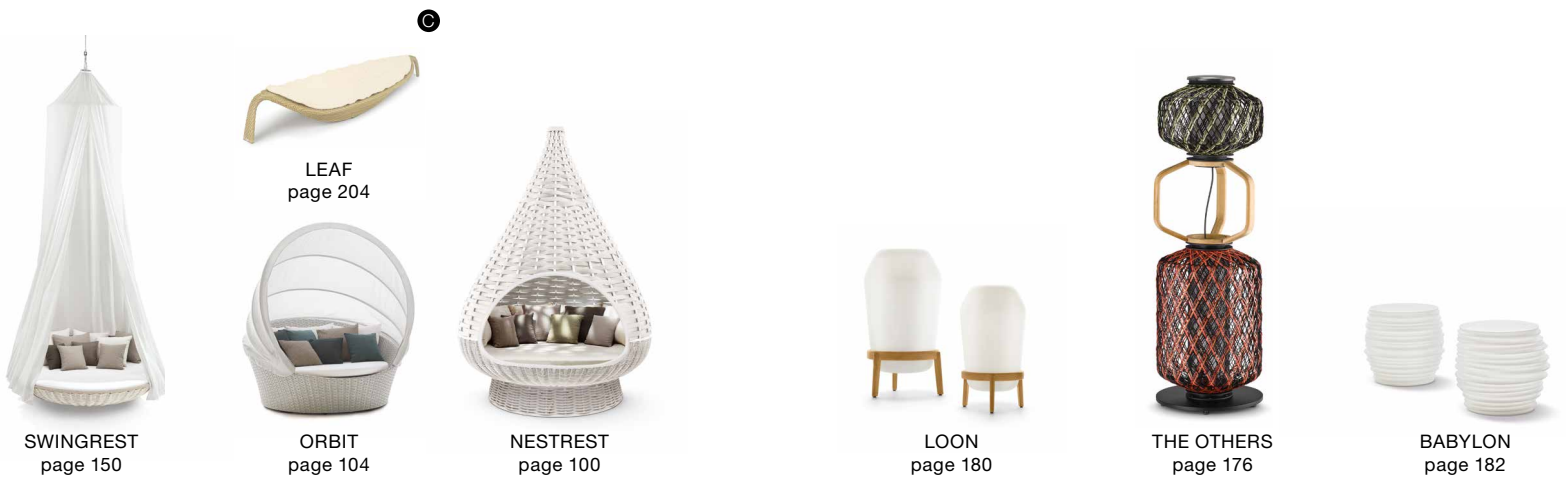

LIGHTING



RESIDENTIAL COLLECTIONS





AHNDA

Design by STEPHEN BURKS, 2016

Loungers and sofas in an open weave of 'transparent upholstery' that reveals the circle structure beneath. Great for curling up or sprawling out.



Wing chair, graphite
Cushion: TWIST sand, LINEN warm gray

Typology

cm inch

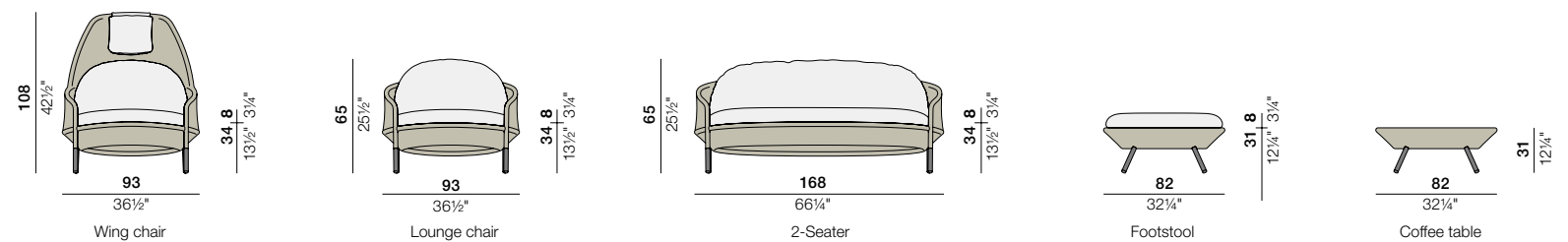

AHNDA

Design by STEPHEN BURKS, 2016









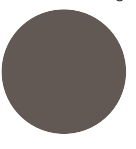
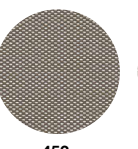

Lounge chair elemental
2-seater elemental
Cushion: TWIST sand
Coffee table Ø 82 cm, Ø 32 1/4"

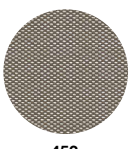

Materials

Combinations

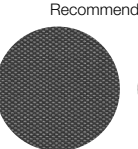
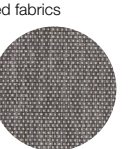
<p>Fiber</p>  <p>105 elemental</p>	<p>Powder coating</p>  <p>099 vulcano</p>	+	<p>Recommended fabrics</p>  <p>452 COOL taupe Cat. A</p>	 <p>661 TWIST sand Cat. B</p>
<p>Fiber</p>  <p>106 white quartz</p>	<p>Powder coating</p>  <p>304 lipari</p>	+	<p>Recommended fabrics</p>  <p>452 COOL taupe Cat. A</p>	 <p>660 TWIST beige Cat. B</p>
<p>Fiber</p>  <p>108 graphite</p>	<p>Powder coating</p>  <p>099 vulcano</p>	+	<p>Recommended fabrics</p>  <p>454 COOL dark gray Cat. A</p>	 <p>662 TWIST gray Cat. B</p>

Tabletop glass

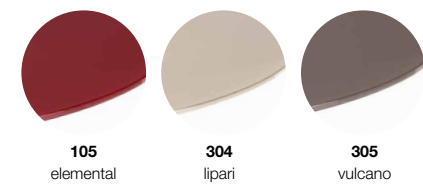

RRP/UVF/PVPR

WING CHAIR
Hochlehner
Sillón orejero

18 kg
40 lbs



SEAT CUSHION
Sitzkissen
Cojín de asiento

81 x 77 cm
32" x 30 1/4"

BACK CUSHION
Rückenkissen
Cojín de respaldo

76 x 38 cm
30" x 15"

DECO CUSHION
Dekokissen
Cojín de decoración

40 x 40 cm
15 3/4" x 15 3/4"

070006

LOUNGE CHAIR
Sessel
Sillón bajo

12 kg
27 lbs

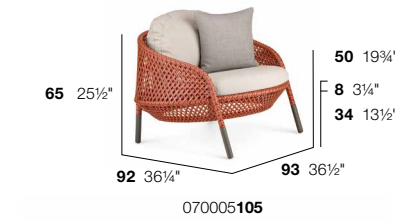

SEAT CUSHION
Sitzkissen
Cojín de asiento

81 x 77 cm
32" x 30 1/4"

BACK CUSHION
Rückenkissen
Cojín de respaldo

76 x 38 cm
30" x 15"

DECO CUSHION
Dekokissen
Cojín de decoración

40 x 40 cm
15 3/4" x 15 3/4"

070005

2-SEATER
2er-Sofa
Sofá 2 plazas

15 kg
34 lbs



SEAT CUSHION
Sitzkissen
Cojín de asiento

154 x 81,5 cm
60 3/4" x 32"

BACK CUSHION
Rückenkissen
Cojín de respaldo

152 x 38 cm
59 3/4" x 15"

070012

FOOTSTOOL
Hocker
Reposapiés

Ø 82 cm
6 kg
Ø 32 1/4"
14 lbs



SEAT CUSHION
Sitzkissen
Cojín de asiento

Ø 80 cm
Ø 31 1/2"

070031

COFFEE TABLE
Kaffeetisch
Mesa de centro

Ø 82 cm
15,5 kg
Ø 32 1/4"
35 lbs

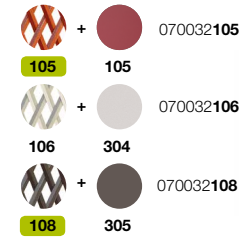

070032

HEADREST CUSHION
Nackenkissen
Cojín reposacabezas

32 x 30 cm
12 1/2" x 11 3/4"



For further information please see DEDON.de/AHNDA



AIIR

Design by GAMFRATESI, 2019

The classic shell chair, reinterpreted for today. Lightness and transparency. Injection-molded seating. Teak legs or sled base. Indoors or out.



Armchair, salt
Side chair, salt
Seat cushion: Kvadrat patio110
Dining table 4+2, 100 x 200 cm 39¼" x 78¾"

Typology

cm inch

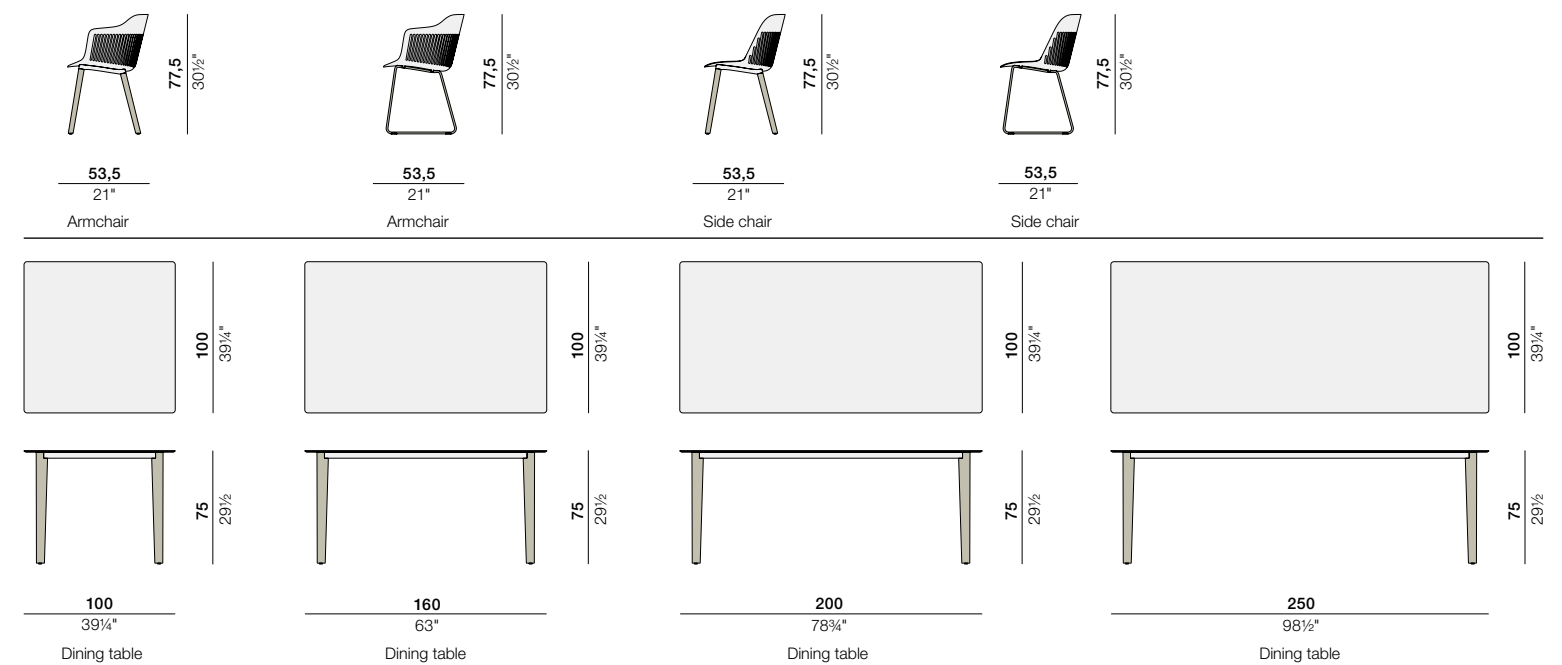

AIIR

Design by GAMFRATESI, 2019



Armchair, pepper
Side chair with sled base, saffron

RRP/UVF/PVPR

ARMCHAIR
Armlehnstuhl
Silla con brazos

6 kg
14 lbs

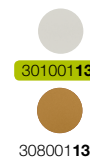

77,5 30½"



307001132

SEAT CUSHION
Sitzkissen
Cojín de asiento

43 x 44,5 cm
17" x 17½"

OPTIONAL BACK CUSHION
Optionales Rückenkissen
Cojín de respaldo opcional

46 x 40 cm
18" x 15¾"



95300001

95103002

56300001000

ARMCHAIR
Armlehnstuhl
Silla con brazos

6,4 kg
15 lbs

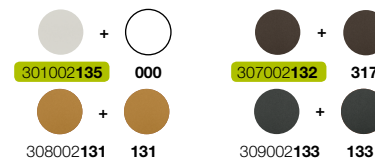

77,5 30½"



307002132

SEAT CUSHION
Sitzkissen
Cojín de asiento

43 x 44,5 cm
17" x 17½"

OPTIONAL BACK CUSHION
Optionales Rückenkissen
Cojín de respaldo opcional

46 x 40 cm
18" x 15¾"



95300001

95103002

56300001000

SIDE CHAIR
Esstuhl
Silla de comedor

5,4 kg
12 lbs

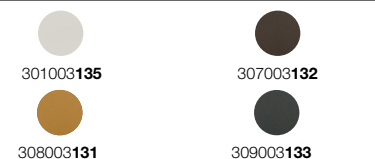

77,5 30½"



307003132

SEAT CUSHION
Sitzkissen
Cojín de asiento

43 x 44,5 cm
17" x 17½"

OPTIONAL BACK CUSHION
Optionales Rückenkissen
Cojín de respaldo opcional

46 x 40 cm
18" x 15¾"



95300001

95103002

56300003000

SIDE CHAIR
Esstuhl
Silla de comedor

5,8 kg
13 lbs

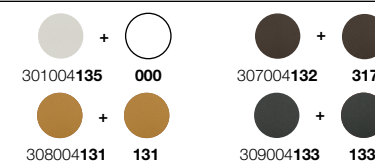

77,5 30½"



307004132

SEAT CUSHION
Sitzkissen
Cojín de asiento

43 x 44,5 cm
17" x 17½"

OPTIONAL BACK CUSHION
Optionales Rückenkissen
Cojín de respaldo opcional

46 x 40 cm
18" x 15¾"



95300001

95103002

56300003000

Materials

Seat

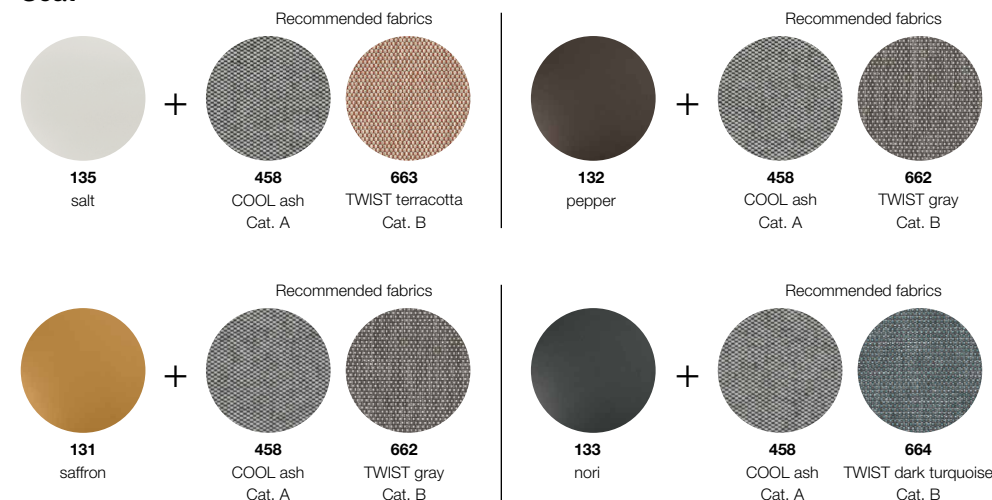

EN MATERIAL

The seats of the AIIR armchairs and side chairs consist of injection molded polypropylene, while the bases are made of premium teak or powder coated stainless steel, which we recommend cleaning periodically to prevent stains. AIIR dining tables come with teak legs and HPL tabletops. Wash teak legs with natural soap dissolved in warm water.

DE MATERIAL

Die Sitzschalen der Sessel und Stühle der AIIR-Reihe werden im Spritzgussverfahren aus Polypropylen hergestellt. Die Untergerüste bestehen aus Premium-Teak oder pulverbeschichtetem Edelstahl. Wir empfehlen eine regelmäßige Reinigung des Untergerüsts, um Fleckenbildung zu vermeiden. Die Beine der AIIR-Esstische sind aus Premium-Teak gefertigt, die Tischplatten bestehen aus HPL. Das Teak-Gestell mit warmem Wasser reinigen, in dem natürliche Seifenflöckchen vollständig aufgelöst wurden.

ES MATERIAL

Los asientos de los sillones y de las sillas AIIR están hechos de polipropileno moldeado por inyección mientras que las bases están elaboradas con teca de primera calidad o acero inoxidable revestido de pintura en polvo, el cual recomendamos limpiar periódicamente para prevenir manchas. Las mesas comedor de AIIR cuentan con patas de teca y tableros HPL. Lavar las patas de teca con agua templada y jabón natural en copos bien disuelto.

Chair base options

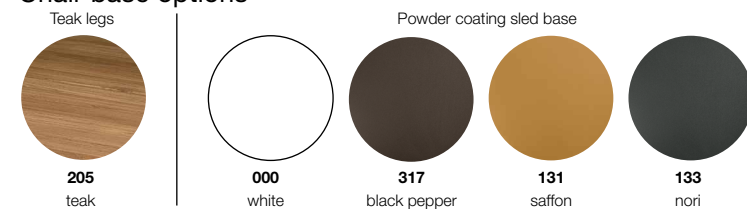

RRP/UVF/PVPR

DINING TABLE
Esstisch
Mesa Comedor

100 × 100 cm
26,8 kg
39¼" × 39¼"
60 lbs

- 303079306
- 306**
- 303079317
- 317**
- 303079001
- 001**

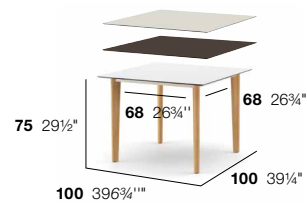

56300079000

DINING TABLE
Esstisch
Mesa Comedor

100 × 160 cm
36,5 kg
39¼" × 63"
81 lbs

- 303071306
- 306**
- 303071317
- 317**
- 303071001
- 001**

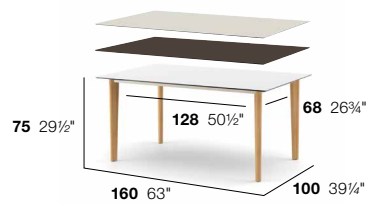

56300071000

DINING TABLE
Esstisch
Mesa Comedor

100 × 200 cm
45,8 kg
39¼" × 78¾"
101 lbs

- 303072306
- 306**
- 303072317
- 317**
- 303072001
- 001**

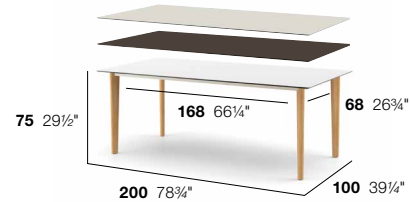

56300072000

DINING TABLE
Esstisch
Mesa Comedor

100 × 250 cm
58,2 kg
39¼" × 98½"
129 lbs

- 303064306
- 306**
- 303064317
- 317**
- 303064001
- 001**

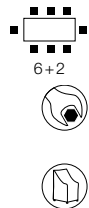
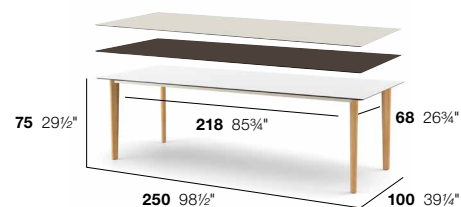

56300064000

Tabletop HPL

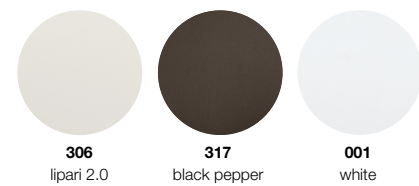

For further information please see [DEDON.de/AIIR](https://www.dedon.de/AIIR)





BABYLON Side table

Design by HARRY-PAUL, 2011

Sculptural, iconic and practical. Crafted from a frost-proof, non-absorbent ceramic with exceptional durability. Complements all DEDON collections.



Side table ceramic

Typology

cm inch

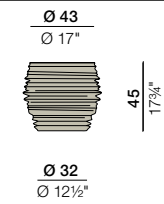

Ø 32
Ø 12 1/2"

Stool/Side table

RRP/UVF/PVPR

STOOL / SIDE TABLE CERAMIC
Hocker / Beistelltisch Keramik
Asiento / Mesa auxiliar de cerámica

Ø 52,5 cm
17 kg
Ø 20 3/4"
38 lbs



Ø 52,5 Ø 20 3/4"

45 17 3/4"

Ø 32 Ø 12 1/2"

053089308

053089

STOOL / SIDE TABLE PE
Hocker / Beistelltisch PE
Asiento / Mesa auxiliar de PE

Ø 52,5 cm
5 kg
Ø 20 3/4"
12 lbs



Ø 52,5 Ø 20 3/4"

45 17 3/4"

Ø 32 Ø 12 1/2"

053111000

EN MATERIAL

Made of Monolite Ipergres®: Frost proof, non-absorbing ceramic material with excellent resistance to scratches, abrasion and indirect tensile stress. Due to method of production, the side table does not have an entirely flat surface.

BABYLON PE consists of rotomolded polyethylene: easy to maintain, 100% recyclable, light yet robust at the same time.

DE MATERIAL

Aus Monolite Ipergres®: ein frostsicheres, wasserabweisendes Keramikmaterial mit ausgezeichneter Kratz- und Abriebfestigkeit. Aus produktionstechnischen Gründen hat der Beistelltisch keine vollständig glatte Oberfläche.

BABYLON PE ist aus rotationsgussgefertigtem Polyethylen hergestellt: einfach zu pflegen, gleichzeitig leicht und widerstandsfähig, 100% recyclingfähig.

ES MATERIAL

Fabricado en Monolite Ipergres® es un material cerámico resistente a las heladas y hermético al agua, con una resistencia excelente contra los arañazos, la abrasión así como a la presión indirecta. Debido a su método de producción, las mesas auxiliares no tienen una superficie completamente regular.

BABYLON PE: Fabricado en polietileno rotomol-deado (PE). De fácil mantenimiento, ligero y al mismo tiempo resistente, 100% reciclable.



For further BABYLON products see page 183



For further information please see DEDON.de/BABYLON



BARCELONA

Design by RICHARD FRINIER, 2004

A balance of tradition and modernity, like the city it was named for.
Comprises lounging and dining elements, all in a subtle weaving pattern.



Armchair, bronze
Cushion: COOL white

Typology

cm inch

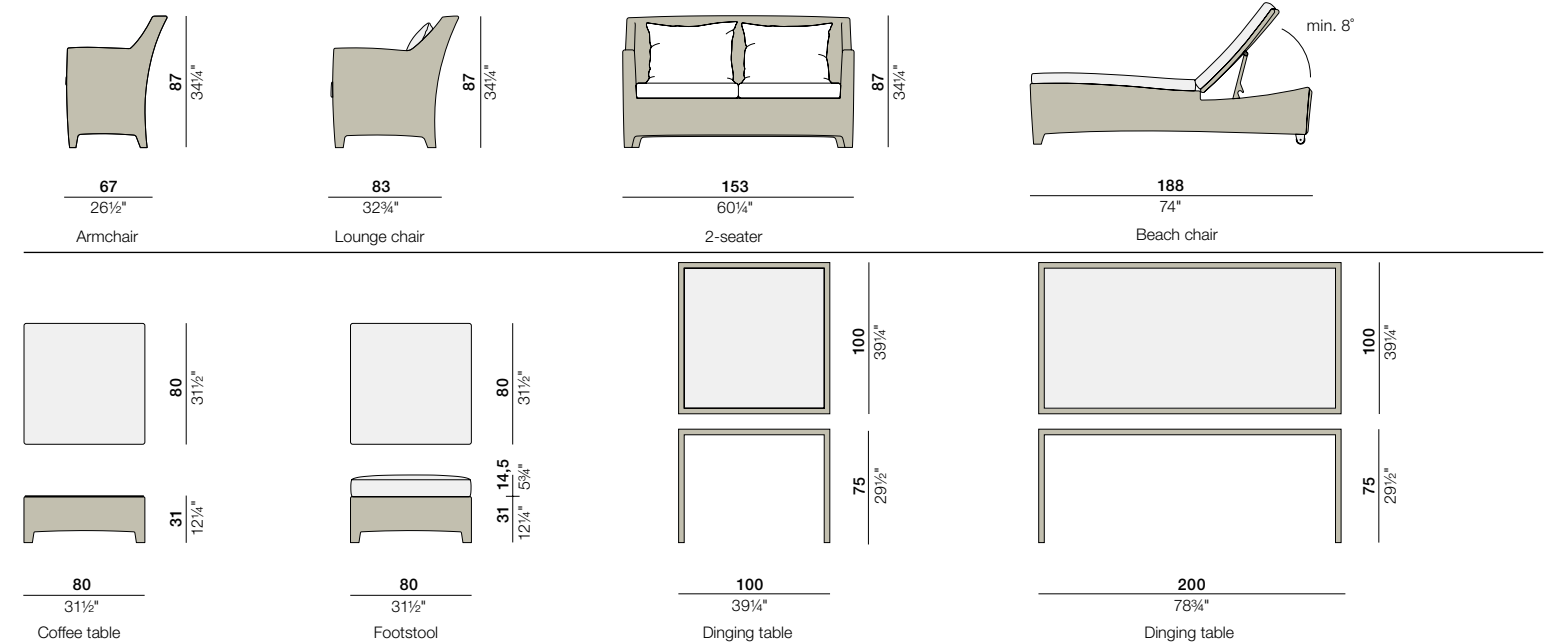

BARCELONA

Design by RICHARD FRINIER, 2004



Armchair, chalk
Cushion: COOL white

Materials

Recommended combinations



Tabletop glass



For further information please see DEDON.de/BARCELONA

RRP/UVF/PVPR

BEACH CHAIR
Sonnenliege
Tumbona

19 kg
42 lbs

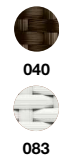

027020

027020083

CUSHION
Kissen
Cojín

78 x 187 cm
30 3/4\"/>

95027020

56027020000

RRP/UVF/PVPR

ARMCHAIR
Armlehnstuhl
Silla con brazos

7 kg
16 lbs

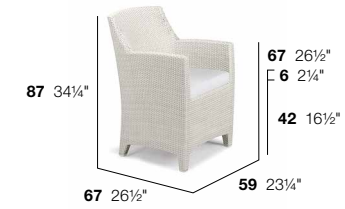

027001083

SEAT CUSHION
Sitzkissen
Cojín de asiento

45 x 46 cm
17 3/4\"/>

95027001

56027001000

DINING TABLE
Esstisch
Mesa comedor

100 x 100 cm
25 kg
39 1/4\"/>



227270083



5602706000

227270

DINING TABLE
Esstisch
Mesa comedor

100 x 200 cm
44 kg
39 1/4\"/>

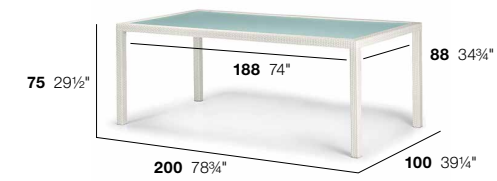

227120083



56027066000

227120

LOUNGE CHAIR
Sessel
Sillón bajo

10 kg
23 lbs



027005083

SEAT CUSHION + BACK CUSHION
Sitzkissen + Rückenkissen
Cojín de asiento + Cojín de respaldo

56 x 61 cm + 50 x 60 cm
22\"/>



56027005000

027005

2-SEATER
2er-Sofa
Sofá 2 plazas

15 kg
33 lbs



027012083

2x SEAT CUSHIONS + 2x BACK CUSHIONS
2x Sitzkissen + 2x Rückenkissen
2x Cojines de asiento + 2x Cojines de respaldo

2 x 67 x 61 cm + 2 x 50 x 60 cm
2 x 26 1/2\"/>



56027012000

027012

COFFEE TABLE
Kaffeetisch
Mesa de centro

80 x 80 cm
16,2 kg
31 1/2\"/>



027038083



56027038000

027038

FOOTSTOOL
Hocker
Reposapiés

80 x 80 cm
7,5 kg
31 1/2\"/>



027037083

SEAT CUSHION
Sitzkissen
Cojín de asiento

80 x 80 cm
31 1/2\"/>

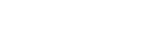

56027037000

027037

95027037

56027037000



BREA

Design by EDWARD BARBER & JAY OSGERBY, 2019

A lounge system of elegant simplicity. Indoor luxury outdoors.
Upholstery can be removed with ease.



Lounge chair
Footstool
Cushion: PUNO reed

Typology

cm inch

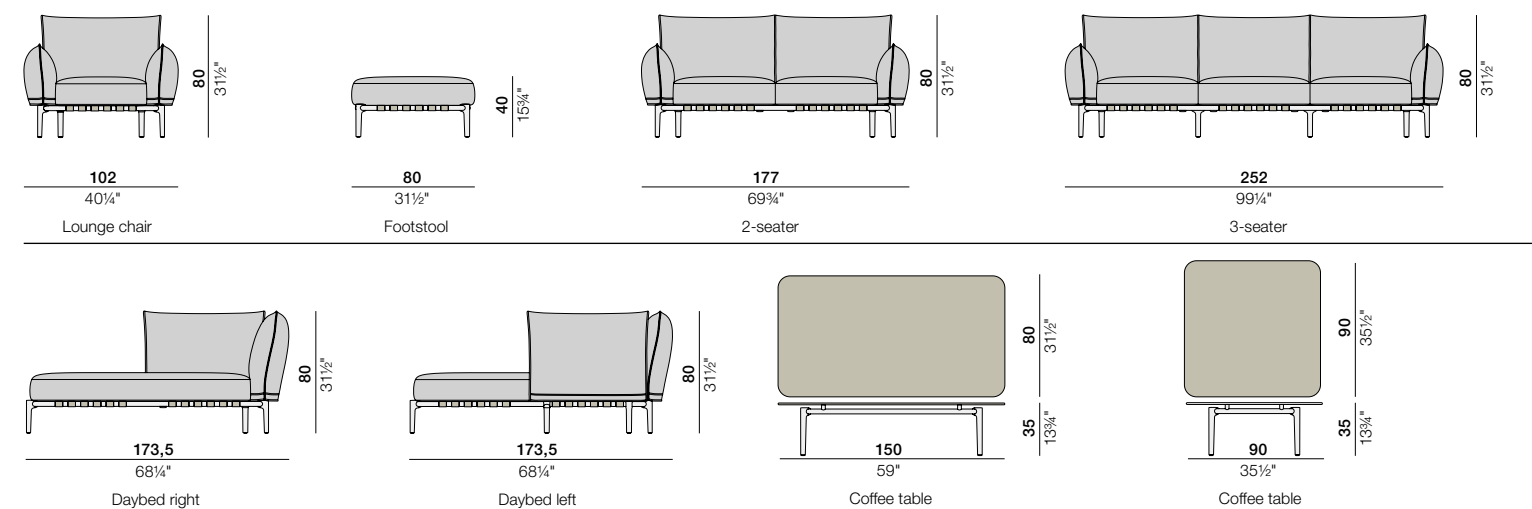

BREA

Design by EDWARD BARBER & JAY OSGERBY, 2019



Lounge chair
3-seater
Cushion: PUNO reed
Coffee table 80 x 150 cm 31½" x 59"

Materials

Recommended fabrics

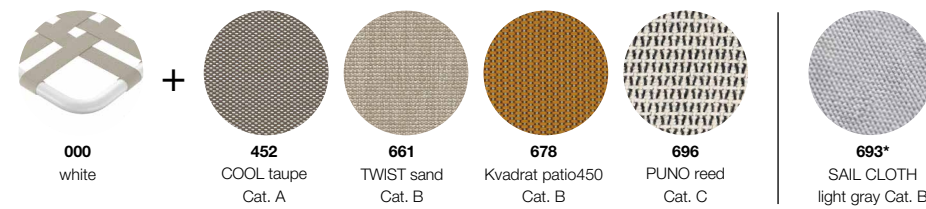

***EN** Fabric for BREA Collection and deco cushions only.
***DE** Stoff nur für BREA Kollektion und Dekokissen erhältlich.
***ES** Solo para la colección BREA y los cojines decorativos.

Tabletop mineral composite



RRP/UV/PVPR

LOUNGE CHAIR
Sessel
Sillón bajo



24 kg
53 lbs



107001

107001000

95107001

56107001000

DRY+ CUSHION SET
Dry+ Kissenset
Dry+ Set de cojines



FOOTSTOOL
Hocker
Taburete



80 x 80 cm
8,3 kg
31½" x 31½"
19 lbs

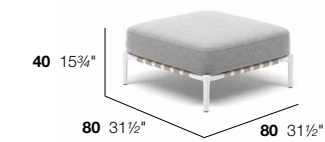

107031

107031000

95107031

56107031000

DRY+ SEAT CUSHION
Dry+ Sitzkissen
Dry+ Cojín de asiento

80 x 80 x 20 cm
31½" x 31½" x 7¾"



2-SEATER
2er-Sofa
Sofá 2 plazas



38 kg
84 lbs



107011

107011000

95107011

56107011000

DRY+ CUSHION SET
Dry+ Kissenset
Dry+ Set de cojines



3-SEATER
3er-Sofa
Sofá 3 plazas



53,5 kg
118 lbs

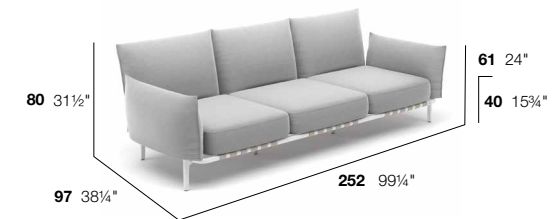

107021

107021000

95107021

56107021000

DRY+ CUSHION SET
Dry+ Kissenset
Dry+ Set de cojines



DAYBED LEFT
Daybed links
Daybed izquierdo



37 kg
82 lbs



107041

107041000

95107041

56107041000

DRY+ CUSHION SET
Dry+ Kissenset
Dry+ Set de cojines



DAYBED RIGHT
Daybed rechts
Daybed derecho



37 kg
82 lbs



107042

107042000

95107042

56107042000

DRY+ CUSHION SET
Dry+ Kissenset
Dry+ Set de cojines



RECOMMENDED DECO CUSHIONS
Empfohlene Dekokissen
Cojines decoración recomendados



95050090

COFFEE TABLE
Kaffeetisch
Mesa de centro



90 x 90 cm
39 kg
35½" x 35½"
86 lbs



107033000

56107033000



107033

COFFEE TABLE
Kaffeetisch
Mesa de centro



80 x 150 cm
49,5 kg
31½" x 59"
110 lbs

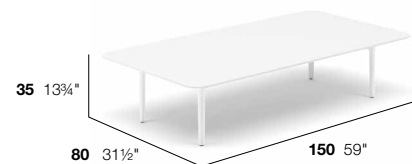

107035000

56107035000

EN MATERIAL

BREA is a comfortable and clever lounging collection with thoughtfully developed upholstery for indoor and outdoor use. BREA consists of a powdercoated metal frame, universal die-cast aluminum legs and connectors, and elastic outdoor belting in Sunbrella® yarns for enhanced comfort. All belting comes in a warm gray color.

The tabletop for the coffee- and side tables consists of a self-supporting, mineral-composite slab, cut using a water jet from the largest premium sintered porcelain slabs available on the market.

DRY+ CUSHIONS

Dry+ cushions are protected by a highly water-repellent interlayer up to 10,000 mm. BREA cushions can be easily slipped on and off the metal frame.

FABRICS

The fabric is treated to be stain- and water-repellent. They are available in Cat. A, Cat. B (incl. Kvadrat PATIO) and Cat. C fabrics. Exclusively for BREA, cushions and deco cushions are available in sail cloth light gray fabric.

COVER

If not used under roof or awning, the modules should be covered with DEDON outdoor covers at night and during rainfall.

DE MATERIAL

BREA ist eine komfortable und intelligente Lounging Kollektion mit durchdachten Polsterelementen für den Innen- und Außenbereich. Das Gestell von BREA besteht aus pulverbeschichteten Aludruckgussbeinen und -verbindungen sowie einem pulverbeschichteten Metallrahmen. Elastische Outdoorriemen von Sunbrella® sorgen für noch mehr Komfort. Die Farbe der Riemen ist für alle Pulverbeschichtungen ein warmes grau.

Die Tischplatten der Kaffeetische und Beistelltische bestehen aus einem freitragenden Mineralverbundmaterial, das per Wasserstrahl aus den größten am Markt erhältlichen gesinterten Porzellanplatten geschnitten wird. Reinigen Sie den Rahmen und die Tischplatten mit einem weichen Tuch und warmem Wasser.

DRY+ KISSEN

Die Dry+ Kissen sind durch eine stark wasserabweisende innere Hülle mit einer Wassersäule von 10.000 mm geschützt. Die Polster-elemente wirken fest verbaut, lassen sich bei Bedarf jedoch im Handumdrehen vom Rahmen herunternehmen.

STOFFE

Der Stoff ist so behandelt, dass er schmutz- und wasserabweisend ist. Erhältlich in DEDON Stoffen der Kategorien A, B (inklusive Kvadrat PATIO) und C, können die Kissenhüllen der Polster-elemente einfach abgezogen werden. Exklusiv erhältlich für BREA werden die Kissen und Dekokissen auch im Stoff sail cloth light gray angeboten.

HUSSEN

Wenn Sie die Möbel nicht auf einer überdachten Fläche oder unter einer Markise aufstellen, empfehlen wir die Module nachts und bei Regen mit DEDON Husen zu schützen.

ES MATERIAL

BREA es una colección de piezas lounge cómodas e inteligentes laboradas con tapicería diseñada a conciencia tanto para uso interior como exterior. La colección BREA está compuesta por estructuras de metal revestidas con pintura poliéster en polvo, patas y conectores de aluminio fundido y correas elásticas para exteriores de Sunbrella®, las cuales aportan un mayor confort. Todas las correas son de un color gris cálido.

Los tableros de las mesas de centro y mesas auxiliares están formados por una placa autoportante de compuesto mineral que ha sido cortada mediante chorro de agua a partir de placas de excelente porcelana sinterizada, las más grandes del mercado. Limpiar la estructura y el tablero con un paño suave y agua tibia.

DRY+ COJINES

Los cojines Dry+ están protegidos con un revestimiento muy impermeable con una resistencia al agua de nada menos que 10.000 mm. Los cojines BREA pueden ponerse y quitarse fácilmente de la estructura metálica. Las fundas de cojín se pueden quitar.

TEJIDOS

La tela está tratada para ser resistente a las manchas y al agua. Están disponibles en tejidos de las categorías A, B (incluyendo Kvadrat PATIO) y C. Exclusivamente para BREA, los cojines y cojines decorativos están disponibles en la tela sail cloth light gray.

FUNDAS

Si no se utiliza bajo techo o toldo, se recomienda cubrir los módulos con las fundas para exteriores DEDON por la noche y durante las lluvias.

BREA**OPTIONAL COMBINATIONS****BREA Setting 01**

1x 107021000 – 3-seater, Dry+ cushion set
1x 107031000 – Footstool, Dry+ seat cushion

Recommended deco cushions:

3x 95050090 – 25 x 62 cm 9¾" x 24¼"
2x 95050082 – 50 x 50 cm 19¾" x 19¾"
1x 95050081 – 40 x 40 cm 15¾" x 15¾"

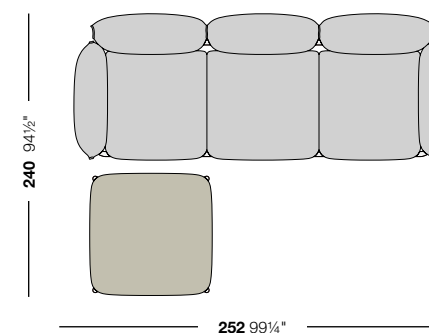
**BREA Setting 02**

1x 107011000 – 2-seater, Dry+ cushion set
1x 107041000 – Daybed left, Dry+ cushion set
1x 107033000 – Coffee table 90 x 90 cm 35½" x 35½"

Recommended deco cushions:

3x 95050090 – 25 x 62 cm 9¾" x 24¼"
2x 95050082 – 50 x 50 cm 19¾" x 19¾"
1x 95050081 – 40 x 40 cm 15¾" x 15¾"

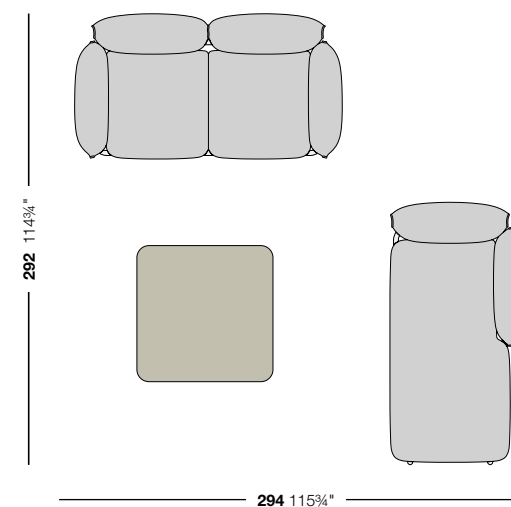
**BREA Setting 03**

1x 107001000 – Lounge chair, Dry+ cushion set
1x 107011000 – 2-seater, Dry+ cushion set
1x 107021000 – 3-seater, Dry+ cushion set
1x 107035000 – Coffee table 80 x 150 cm 31½" x 59"

Recommended deco cushions:

6x 95050090 – 25 x 62 cm 9¾" x 24¼"
3x 95050082 – 50 x 50 cm 19¾" x 19¾"
3x 95050081 – 40 x 40 cm 15¾" x 15¾"

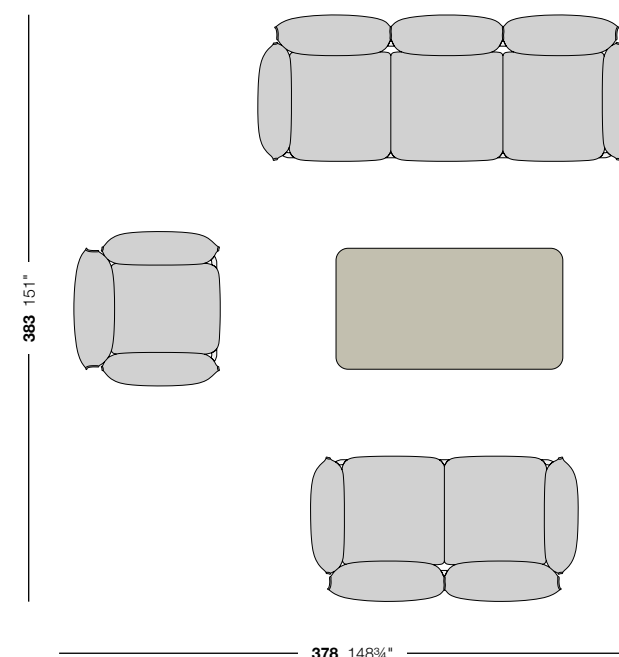

For further information please see [DEDON.de/BREA](https://www.dedon.de/BREA)



BRIXX

Design by LORENZA BOZZOLI, 2017

Upholstered rectangular modules. Playful yet functional. 360° accessibility. Fixed or flexible backrests. Created with top Italian upholsterers.



Sofa module M, PUNO straw
Side table triangular, lipari
Sofa module L, PUNO reed
Module S, PUNO straw/reed
Sofa module M, PUNO straw
Side table triangular, lipari

Typology

cm inch

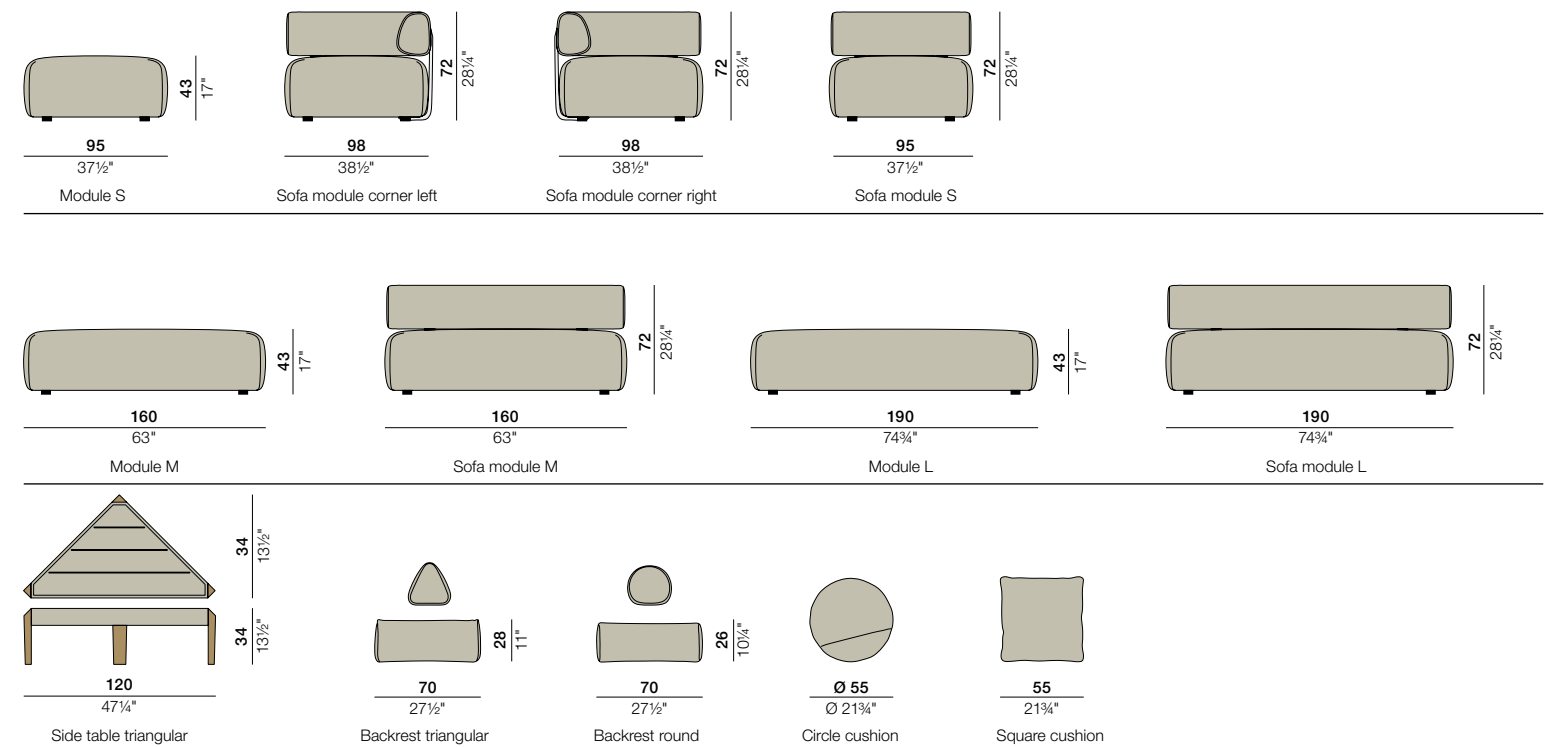

BRIX

Design by LORENZA BOZZOLI, 2017



Sofa module M, PUNO straw
Side table triangular, lipari
Sofa module L, PUNO reed
Module S, PUNO straw/reed
Sofa module M, PUNO straw
Side table triangular, lipari

Materials

Recommended fabrics for backrest round, backrest triangular, square cushion



EN MATERIAL
BRIX is a comfortable, upholstered modular system for indoor and outdoor use. Its structure consists of a powdercoated steel frame encased in molded polyurethane foam, with belting for extra comfort. The side table consists of a powder-coated aluminum top and natural teak legs.

FABRICS
BRIX is only available in DUNE and PUNO fabric. Circle cushion is only available in DUNE cove/shore 697 and PUNO straw/reed 694. The fabric consists of 50% acrylic yarn and 50% recycled post-industrial acrylic yarn. Like all DEDON acrylic fabrics, those used for BRIX are highly UV-resistant. The recycled yarn includes imperfections that give the fabric its very natural and appealing look.

COVER
If not used under roof or awning, we recommend covering the modules with DEDON outdoor covers at night and during rainfall.

DE MATERIAL
BRIX ist ein komfortables, gepolstertes Modulare System, das Sie sowohl im Innen- als auch im Außenbereich nutzen können. Die Möbel dieser Kollektion bestehen aus pulverbeschichteten Stahlrahmen, die mit formgeschäumtem Polyurethanschaum verkleidet sind. Riemen sorgen für noch mehr Komfort. Der Beistelltisch wird aus pulverbeschichtetem Aluminium und Beinen aus naturbelassenem Teakholz gefertigt.

STOFFE
BRIX ist nur erhältlich in den Stoffen DUNE und PUNO. Das runde Kissen ist nur in DUNE cove/shore 697 und PUNO straw/reed 694 verfügbar. Der Stoff besteht zu 50% aus Acrylgarn und zu 50% aus recyceltem Acrylgarn. Wie alle DEDON Stoffe aus Acryl sind auch die Stoffe, die für BRIX verwendet werden, extrem widerstandsfähig gegen UV-Strahlen. Das recycelte Garn zeichnet sich durch kleine Unregelmäßigkeiten aus, was dem Stoff einen sehr natürlichen und außergewöhnlichen Look verleiht.

HUSSEN
Wenn Sie die Möbel nicht auf einer überdachten Fläche oder unter einer Markise aufstellen, empfehlen wir die Module nachts und bei Regen mit DEDON Husen zu schützen.

ES MATERIAL
BRIX es un cómodo sistema tapizado y modular de uso tanto en interiores como en exteriores. Su estructura consiste en un armazón de acero electro pintado recubierto con espuma moldeada de poliuretano, con cinturones para mayor comodidad. La mesa triangular consiste de un sobre de aluminio con acabado de pintura en polvo y patas de teca natural.

TEJIDOS
BRIX sólo se encuentra disponible en tejidos DUNE y PUNO. El cojín redondo sólo se encuentra disponible en cove/shore DUNE 697 y straw/reed PUNO 694. El tejido se compone de fibras con un 50 % de acrílico y un 50 % de acrílico reciclado. Al igual que todos los tejidos acrílicos DEDON, los tejidos utilizados por BRIX son también altamente resistentes a los rayos UV. La fibra reciclada incluye imperfecciones que dotan a la tela de un aspecto muy natural y atractivo.

FUNDAS
Si no se utiliza bajo techo o toldo, se recomienda cubrir los módulos con las fundas para exteriores DEDON por la noche y durante las lluvias.

RRP/UV/PVPR

MODULE S
Modul S
Módulo S

95 x 95 cm
28 kg
37½" x 37½"
62 lbs

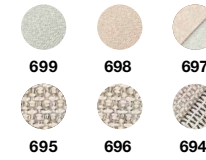

092016697



56092016000

092016

SOFA MODULE CORNER LEFT
Sofa Eckmodul links
Módulo sofá esquina izquierdo

98 x 98 cm
48,3 kg
38½" x 38½"
107 lbs

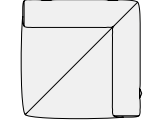

092019698



56092018000

092019

SOFA MODULE CORNER RIGHT
Sofa Eckmodul rechts
Módulo sofá esquina derecho

98 x 98 cm
48,3 kg
38½" x 38½"
107 lbs

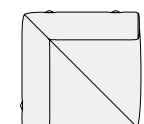

092018698



56092018000

092018

SOFA MODULE S
Sofa Modul S
Módulo sofá S

98 x 95 cm
39,8 kg
38½" x 37½"
88 lbs



092017698



56092017000

092017

MODULE M
Modul M
Módulo M

95 x 160 cm
46,6 kg
37½" x 63"
103 lbs

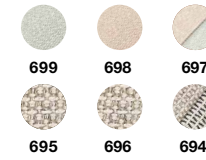

092013697



56092013000

092013

SOFA MODULE M
Sofa Modul M
Módulo sofá M

98 x 160 cm
60,3 kg
38½" x 63"
133 lbs



092012698



56092012000

092012

BACKREST TRIANGULAR
Rückenlehne dreieckig
Respaldo triangular

7,3 kg
17 lbs

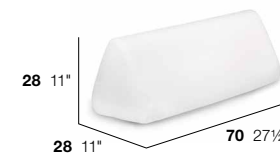

BACKREST ROUND
Rückenlehne rund
Respaldo redondo

7,3 kg
17 lbs

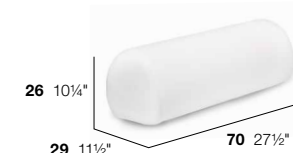

For further information please see DEDON.de/BRIX

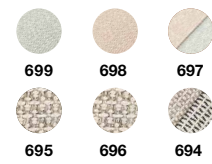
MODULE L
Modul L
Módulo L

95 x 190 cm
53,5 kg
37½" x 74¾"
118 lbs



092014697

56092014000

092014

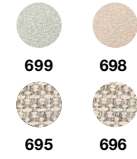
SOFA MODULE L
Sofa Modul L
Módulo sofá L

98 x 190 cm
70,7 kg
38½" x 74¾"
156 lbs



092015698

56092015000

092015

SQUARE CUSHION
Kissen viereckig
Cojín cuadrado

55 21¾"

CIRCLE CUSHION
Kissen rund
Cojín redondo

95092089697

95092089694

Ø 55 Ø 21¾"

95092084

SIDE TABLE TRIANGULAR
Beistelltisch dreieckig
Mesa triangular

85 33½"

092035098

56092035000

092035

DRY+ CUSHION CONSTRUCTION

EN DRY+ CUSHION

Dry+ cushions are protected by a highly water-repellent interlayer up to 10,000 mm. The fabric is treated to be stain- and water-repellent. The triangular and round backrests are equipped with a heavy core and anti-slip pads in order to give ideal support.

DE DRY+ KISSEN

Der Kern jedes Moduls wird durch eine stark wasserabweisende innere Hülle mit einer Wassersäule von 10.000 mm geschützt. Der Stoff ist so behandelt, dass er schmutz- und wasserabweisend ist. Die dreieckigen und runden Rückenlehnen sind mit einem schweren Kern und rutschfestem Unterboden ausgestattet, wodurch sie ideal stützen.

ES DRY+ COJINES

El relleno de cada módulo está protegido con un revestimiento altamente impermeable con una resistencia al agua de 10.000 mm. La tela está tratada para ser resistente a las manchas y al agua. Si no se utiliza bajo techo o toldo, se recomienda cubrir los módulos con las fundas para exteriores DEDON por la noche y durante las lluvias. Los respaldos triangulares y redondos están equipados con un pesado núcleo y textil antideslizante con el fin de proporcionar un soporte ideal.

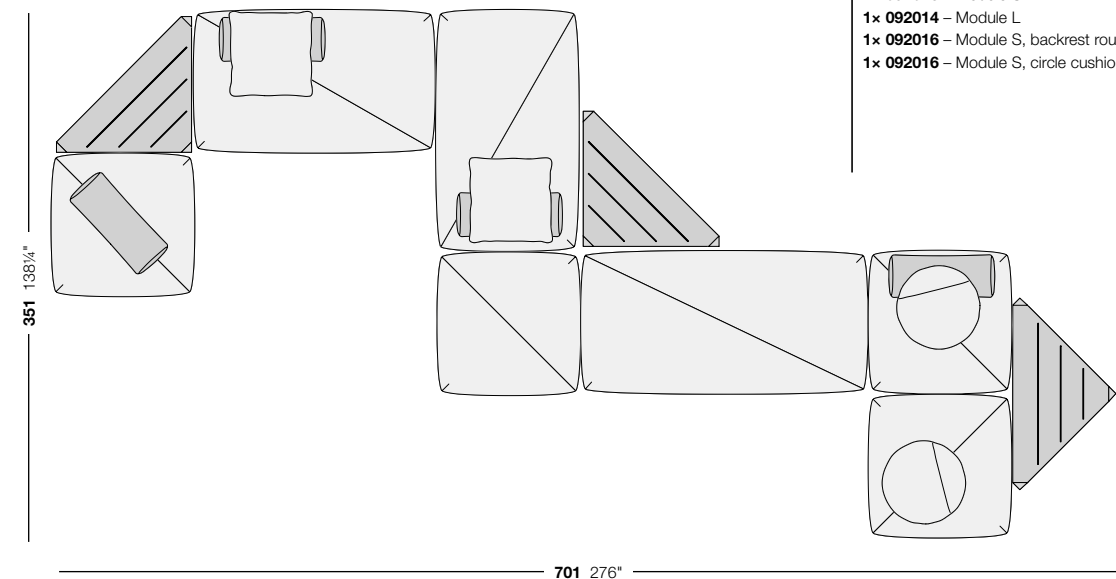
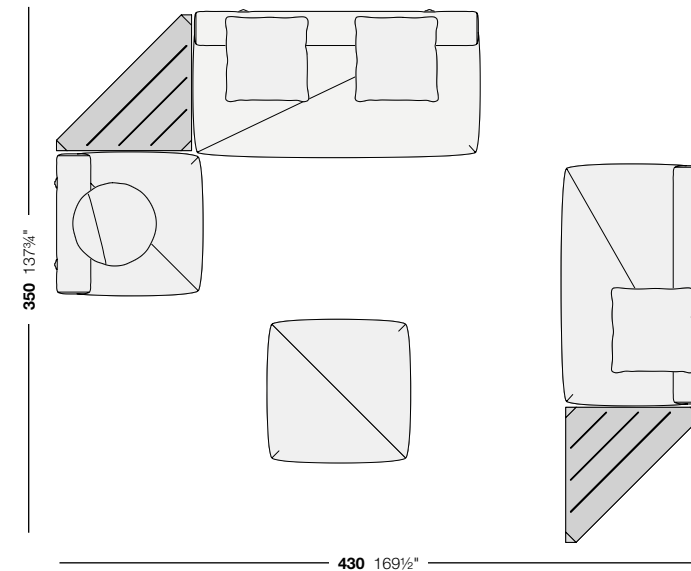
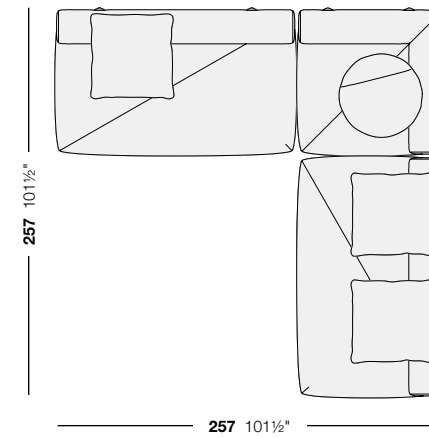
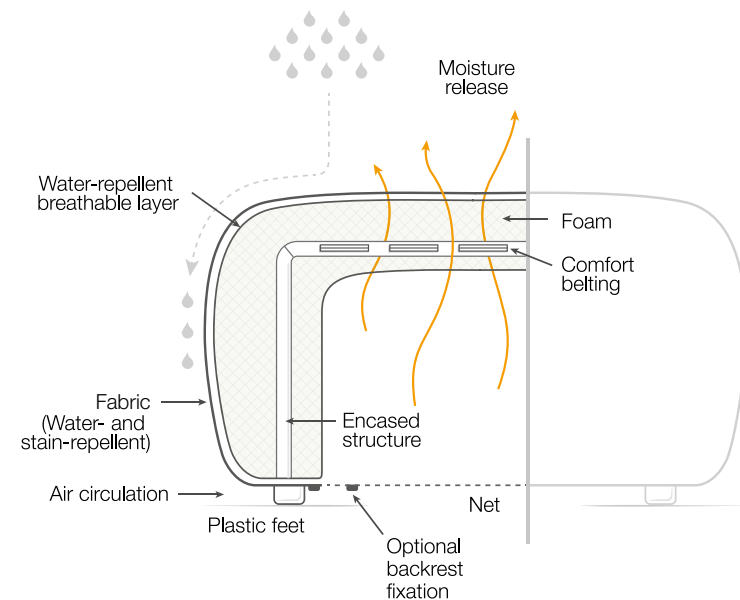

BRIXX Setting S

- 1x 092012 – Sofa module M + square cushion
- 1x 092019 – Sofa corner module + circle cushion
- 1x 092012 – Sofa module M + 2 x square cushion

BRIXX Setting M

- 1x 092017 – Sofa module S + circle cushion
- 2x 092035 – Side table triangular
- 1x 092015 – Sofa module L + square cushions
- 1x 092016 – Module S
- 1x 092012 – Sofa module M + square cushion

BRIXX Setting L

- 1x 092016 – Module S, backrest round
- 3x 092035 – Side table triangular
- 2x 092013 – Module M, backrest triangular + square cushion
- 1x 092016 – Module S
- 1x 092014 – Module L
- 1x 092016 – Module S, backrest round + circle cushion
- 1x 092016 – Module S, circle cushion



CIRQL

Design by WERNER AISSLINGER, 2019

A new archetype for a chair. Round, friendly shapes and a sophisticated circular weave. The coordinated palette offers unique opportunities for color play.



Armchairs: saffron, bluestone, jade

Typology

cm inch

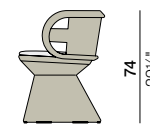

57
22 1/2"

Armchair, central base



57
22 1/2"

Armchair



77
30 1/4"

Lounge chair

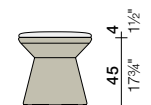

45
17 3/4"
Ø 48,5
Ø 19"

Footstool



45
17 3/4"
Ø 48,5
Ø 19"

Side table

CIRQL

Design by WERNER AISSLINGER, 2019



Armchair, central base, onyx/carbon
Side table, onyx/carbon

Materials

Fibers

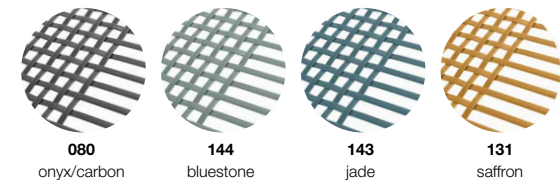

Tabletops powder coated metal

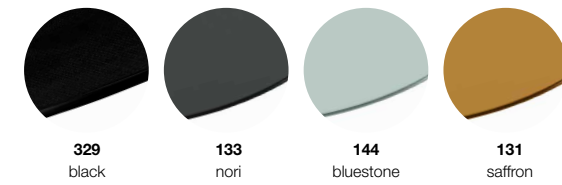

Recommended fabrics

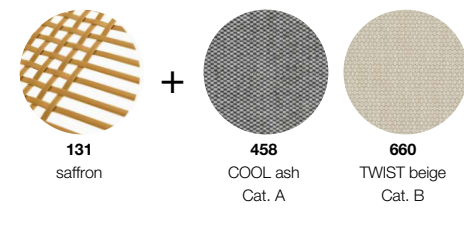
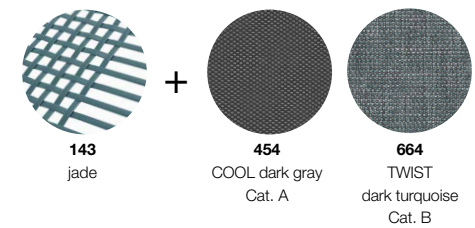
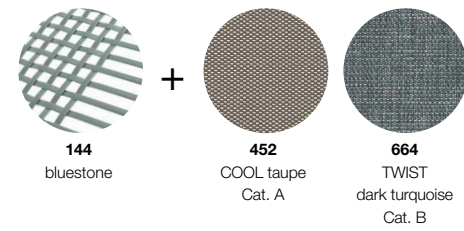
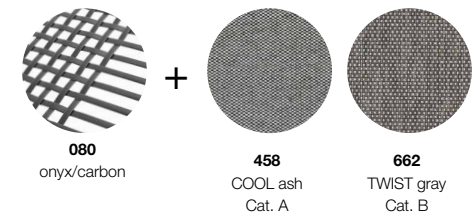

RRP/UVF/PVPR

ARMCHAIR, CENTRAL BASE
Armlehnstuhl, Standfuß
Silla con brazos, base central

4,9 kg
11 lbs

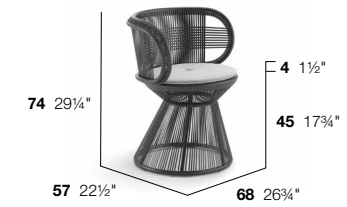

SEAT CUSHION
Sitzkissen
Cojín de asiento

Ø 48 cm
Ø 19"

104002

ARMCHAIR
Armlehnstuhl
Silla con brazos

3,9 kg
9 lbs



SEAT CUSHION
Sitzkissen
Cojín de asiento

Ø 48 cm
Ø 19"

104001

LOUNGE CHAIR
Sessel
Sillón bajo

4,6 kg
11 lbs



SEAT CUSHION
Sitzkissen
Cojín de asiento

Ø 63 cm
Ø 24 3/4"

104003

STOOL
Hocker
Asiento

3,1 kg
7 lbs



SEAT CUSHION
Sitzkissen
Cojín de asiento

Ø 48 cm
Ø 19"

104004

SIDE TABLE
Beistelltisch
Mesa auxiliar

5,1 kg
11,4 lbs

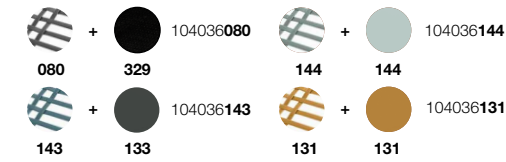

SEAT CUSHION
Sitzkissen
Cojín de asiento

Ø 48 cm
Ø 19"

Complementary tables



SEAX dining table
702040203 *ebony / black*



WA dining table
00607062205 *black pepper / teak*

EN MATERIAL

CIRQL furniture consists of DEDON Fiber woven over a powder coated aluminum frame.

The tabletops of the side tables are made of metal that has been powder coated in a color corresponding to that of the fiber. Clean with a soft cloth and warm water.

DE MATERIAL

Die CIRQL Möbel sind aus DEDON-Faser gefertigt, die auf einem pulverbeschichteten Aluminiumrahmen geflochten ist.

Die Tischplatten der Beistelltische bestehen aus pulverbeschichtetem Metall passend zur Farbe der DEDON-Faser. Einfach mit einem weichen Tuch und warmem Wasser zu reinigen.

ES MATERIAL

Los muebles de CIRQL están fabricados con fibra trenzada DEDON sobre una estructura de aluminio recubierto en polvo.

Los tableros de las mesas auxiliares están hechos con metal recubierto en polvo que combina con el color de la fibra. Limpiar con un paño suave y agua tibia.



For further information please see [DEDON.de/CIRQL](https://www.dedon.de/CIRQL)



DALA

Design by STEPHEN BURKS, 2013

A celebration of artisanship. Sophisticated weaving pattern in decorative colorways. Circular seating. Contemporary.



Lounge chair ubud
Cushion: GLAN teal
Lounge chair cuba
Cushion: GLAN terra
Lounge chair ibiza
Cushion: GLAN drift
Lounge chair rioja
Cushion: GLAN shale
Lounge chair bahamas
Cushion: GLAN teal

Typology

cm inch

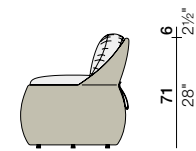

72,5
28 1/2"

Club chair

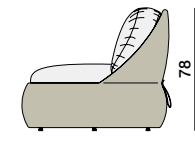

97

38 1/4"

Lounge chair

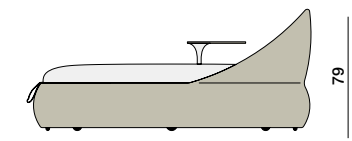

179

Ø 70 1/2"

Loveseat

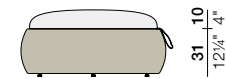

Ø 96

Ø 37 3/4"

Footstool



Ø 97

Ø 38 1/4"

Coffee table



Ø 60

Ø 23 1/2"

Stool

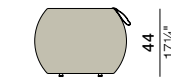

Ø 60

Ø 23 1/2"

Side table

DALA

Design by STEPHEN BURKS, 2013



Club chair ibiza
Cushion: GLAN drift
Side table ibiza Ø 60 cm Ø 23½"

Materials

Combinations

Fiber	Powder coating		Recommended fabric		
		+			
NEW			Cat. A	Cat. B	Cat. C
164	133		452	661	707
rioja	nori		COOL taupe	TWIST sand	GLAN shale

Fiber	Powder coating		Recommended fabric		
		+			
NEW			Cat. A	Cat. B	Cat. C
165	329		458	664	708
ubud	black		COOL ash	TWIST turquoise	GLAN teal

Fiber	Powder coating		Recommended fabric		
		+			
NEW			Cat. A	Cat. B	Cat. C
166	084		456	685	709
cuba	terracotta		COOL marsala	MAR terracotta	GLAN terra

Fiber	Powder coating		Recommended fabric		
		+			
NEW			Cat. A	Cat. B	Cat. C
167	000		462	660	706
ibiza	white		COOL sage	TWIST beige	GLAN drift

Fiber	Powder coating		Recommended fabric		
		+			
NEW			Cat. A	Cat. B	Cat. C
168	000		450	684	708
bahamas	white		COOL white	MAR nori	GLAN teal

RRP/UVF/PVPR

CLUB CHAIR
Club chair
Club chair

6,6 kg
15 lbs



SEAT CUSHION
Sitzkissen
Cojín de asiento

BACK CUSHION
Rückenkissen
Cojín de respaldo



073003

073003164

95073302

95073303

56073003000

LOUNGE CHAIR
Sessel
Sillón bajo

9,3 kg
21 lbs

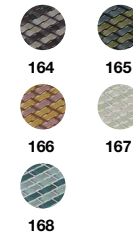

SEAT CUSHION
Sitzkissen
Cojín de asiento

BACK CUSHION
Rückenkissen
Cojín de respaldo



073005

073005164

95073337

95073305

56073006000

STOOL
Hocker
Asiento

Ø 60 cm
4,5 kg
Ø 23½"



SEAT CUSHION
Sitzkissen
Cojín de asiento



073035

073035164

95073333

56073036000

SIDE TABLE
Beistelltisch
Mesa auxiliar

Ø 60 cm
6,8 kg
Ø 23½"



Ø 60 Ø 23½"

073036164



073036

FOOTSTOOL
Hocker
Taburete

Ø 96 cm
6,7 kg
Ø 37¾"



SEAT CUSHION
Sitzkissen
Cojín de asiento



073037

073037164

95073337

56073038000

COFFEE TABLE
Kaffeetisch
Mesa de centro

Ø 96 cm
17 kg
Ø 37¾"



Ø 96 Ø 37¾"

073038164



073038

Tabletops glass

133 nori	084 terracotta	314 stone
Top: satinated glass Bottom: lacquered in nori	Top: satinated glass Bottom: lacquered in terracotta	Top: satinated glass Bottom: lacquered in stone

RRP/UVF/PVPR

LOVESEAT
Sofainset
Sofá isla



Ø 179 cm
30 kg
Ø 70½"



SEAT CUSHION
Sitzkissen
Cojín de asiento



073004 073004164 95073314 56073014000

RECOMMENDED DECO CUSHIONS
Empfohlene Dekokissen
Cojines decoración recomendados

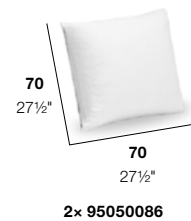

2x 95050086

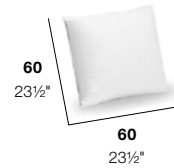

2x 95050084

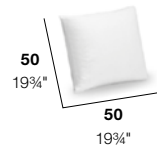

1x 95050082

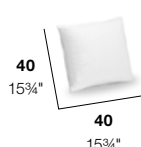

1x 95050081

EN The loveseat is shipped with pre-mounted pullout casters.

DE Die Sofainset wird inkl. vormontierter ausklappbarer Räder geliefert.

ES El sofá isla se entrega con ruedas premontadas plegables.



EN MATERIAL

The swiveling table of the DALA loveseat consists of a powder coated aluminum post and a tabletop of crosslaminated premium teak veneer.

DE MATERIAL

Der Schwenktisch der DALA Sofainset besteht aus einer pulverbeschichteten Aluminiumhalterung und einer Tischplatte aus hochwertigem Teak-Schichtholz.

ES MATERIAL

La mesa giratoria integrada en el DALA sofá isla está hecha de aluminio revestido con pintura poliéster en polvo altamente resistente y un tablero de chapa de madera de teca laminada de la mejor calidad.



For further information please see DEDON.de/DALA



For more DALA products see page 186



DEAN

Design by JEAN-MARIE MASSAUD, 2017

A breakthrough in sling-chair construction. Timeless and sophisticated design. Luxurious double-sling fabric. Teak armrest insets.



4x DEAN armchair black
SEAX dining table 100 x 200 cm 39¼" x 78¾" teak/black

Typology

cm inch

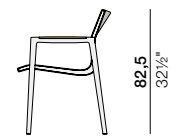

61,5
24¼"

Armchair



69,5

27¼"

Lounge chair

DEAN

Design by JEAN-MARIE MASSAUD, 2017



Lounge chair, pearl gray & white
Armchair, anthracite & black

RRP/UVF/PVPR

ARMCHAIR
Armlehnstuhl
Silla con brazos

11 kg
25 lbs

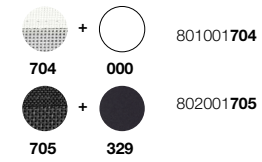

801001704

802001705



801001704



56800001000

LOUNGE CHAIR
Sessel
Sillón bajo

11 kg
25 lbs

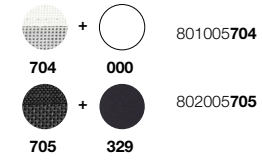

801005704

802005705



801005704



56800005000

Complementary tables



SEAX table
701040205 teak / white
See page 146



SEAX coffee table
702036203 ebony / black
See page 149



SATELLITE side table
050133000 white
See page 127

Materials

Combinations

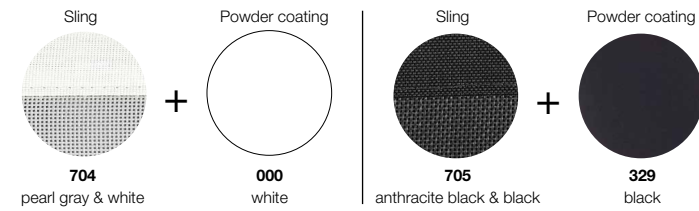

EN MATERIAL

DEAN's frame is made of powder coated aluminum. Its seat and back consist of textile in a mix of PVC and PES. Clean frame, seat and backrest with a soft cloth and warm water. Clean natural-teak armrest inlays with a damp cloth, and do not apply cleaning detergents of any kind.

DE MATERIAL

Der Rahmen von DEAN besteht aus pulverbeschichtetem Aluminium. Das Gewebe der Sitzfläche und der Rückenlehne ist eine Mischung aus PVC und Polyester. Reinigen Sie den Rahmen, die Sitzfläche und die Rückenlehne mit einem weichen Tuch und warmem Wasser. Die Einlage in den Armlehnen besteht aus naturbelassenem Teakholz. Diese reinigen Sie mit einem feuchten Tuch und keinesfalls mit Reinigungsmitteln.

ES MATERIAL

El armazón de DEAN está hecho de aluminio de fundición revestido de pintura en polvo. Su asiento y respaldo constan de un tejido mezcla de PVC y PES. Limpie la estructura, asiento y respaldo con un paño suave y agua tibia. Limpie las incrustaciones en los reposabrazos de teca natural con un paño húmedo y no aplique detergentes limpiadores de ningún tipo.

Optional combinations

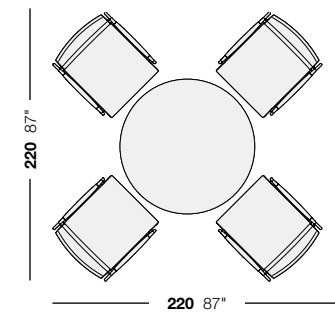

DEAN meets SEAX lounge setting

- 1x 702036 – SEAX coffee table
Ø 110 cm Ø 43 1/4", teak/black
- 4x 801005 – DEAN lounge chair

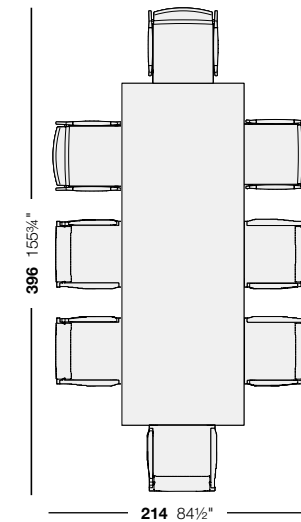

DEAN meets SEAX dining setting

- 1x 702040 – SEAX dining table
100 x 220 cm 39 1/4" x 86 1/2", teak
- 5x 702311 – SEAX armchair
- 3x 802001 – DEAN armchair



For further information please see DEDON.de/DEAN



IZON

Design by ARIK LEVY, 2020

Coffee and side tables designed to mix, match and even overlap. Select from a range of materials, colors, planes and proportions to create unique arrangements.



Coffee table black pepper/lava, Ø 111 cm Ø 43¾"
Coffee table black pepper/lava 50 x 130 cm 19¾" x 51¼"

Typology

cm inch

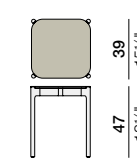

39
15¼"
Side table

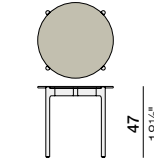

Ø 54,5
Ø 21½"
Side table

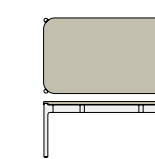

90
35½"
Coffee table

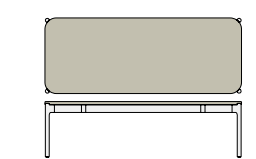

130
51¼"
Coffee table

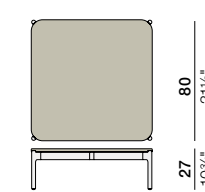

80
31½"
Coffee table

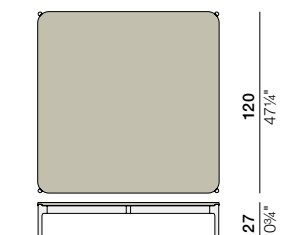

120
47¼"
Coffee table

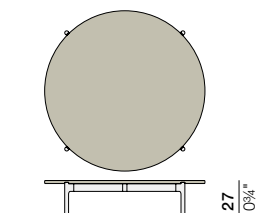

Ø 111
Ø 43¾"
Coffee table

IZON

Design by ARIK LEVY, 2020



Coffee table, 50 x 130 cm 19 3/4" x 51 1/4", lipari/HPL lipari 2.0
Side table, Ø 54,5 cm Ø 21 1/2", lipari/HPL lipari 2.0

Materials

Frames

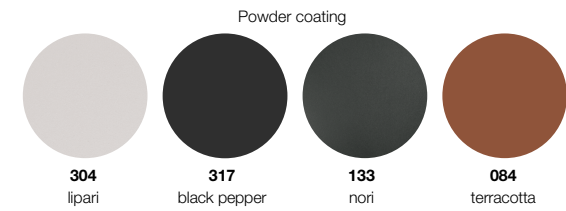

Tabletops

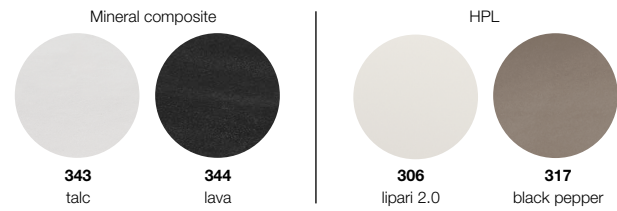
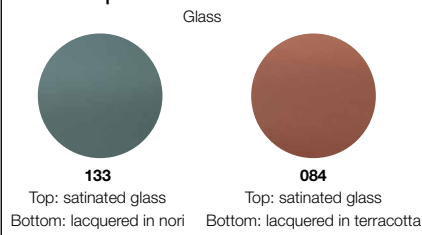

RRP/UVF/PVPR

SIDE TABLE
Beistelltisch
Mesa auxiliar

39 x 39 cm
7,3 kg
15 1/4" x 15 1/4"
16 lbs

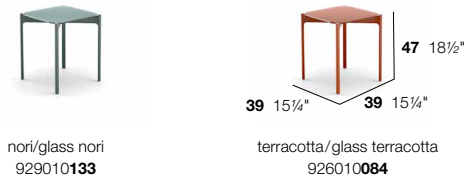

nori/glass nori
929010133

terracotta/glass terracotta
926010084

56900010000

5,6 kg
13 lbs



lipari/HPL lipari 2.0
913010306

black pepper/HPL black pepper
917010317

RRP/UVF/PVPR

SIDE TABLE
Beistelltisch
Mesa auxiliar

Ø 54,5 cm
8,5 kg
Ø 21 1/2"
19 lbs



nori/glass nori
929020133



Ø 54,5 Ø 21 1/2"
terracotta/glass terracotta
926020084

56900020000

6,3 kg
14 lbs



lipari/HPL lipari 2.0
913020306



black pepper/HPL black pepper
917020317

COFFEE TABLE
Kaffeetisch
Mesa de centro

Ø 111 cm
29 kg
Ø 43 3/4"
64 lbs



lipari/talc
933050343



Ø 111 Ø 43 3/4"
black pepper/lava
937050344

56900050000

16,4 kg
37 lbs



lipari/HPL lipari 2.0
913050306



black pepper/HPL black pepper
917050317

COFFEE TABLE
Kaffeetisch
Mesa de centro

80 x 80 cm
21,9 kg
31 1/2" x 31 1/2"
48 lbs



lipari/talc
933030343



80 31 1/2" 27 10 3/4" 80 31 1/2"

black pepper/lava
937030344

56900030000

12,6 kg
28 lbs



lipari/HPL lipari 2.0
913030306



black pepper/HPL black pepper
917030317

RRP/UVR/PVPR

COFFEE TABLE
Kaffeetisch
Mesa de centro

120 x 120 cm
44,6 kg
47 1/4" x 47 1/4"
98 lbs



lipari/talc
933040343

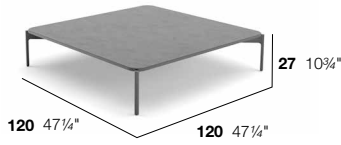

120 47 1/4" 120 47 1/4" 27 10 3/4"
black pepper/lava
937040344



56900040000

24,1 kg
54 lbs



lipari/HPL lipari 2.0
913040306



black pepper/HPL black pepper
917040317

COFFEE TABLE
Kaffeetisch
Mesa de centro

50 x 90 cm
15,8 kg
19 3/4" x 35 1/2"
35 lbs



lipari/talc
933060343

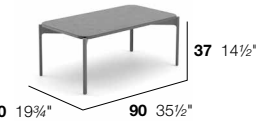

50 19 3/4" 90 35 1/2" 37 14 1/2"
black pepper/lava
937060344



56900060000

9,9 kg
22 lbs



lipari/HPL lipari 2.0
913060306



black pepper/HPL black pepper
917060317

COFFEE TABLE
Kaffeetisch
Mesa de centro

50 x 130 cm
22,1 kg
19 3/4" x 51 1/4"
49 lbs



lipari/talc
933070343

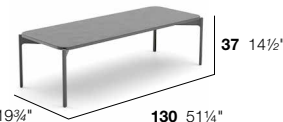

50 19 3/4" 130 51 1/4" 37 14 1/2"
black pepper/lava
937070344



58900070000

12,9 kg
29 lbs



lipari/HPL lipari 2.0
913070306



black pepper/HPL black pepper
917070317

IZON

OPTIONAL COMBINATIONS



IZON Setting 01

1x 937060344 – Coffee table, 50 x 90 cm 19 3/4" x 35 1/2", black pepper/lava
1x 926010084 – Side table, 39 x 39 cm 15 1/4" x 15 1/4", terracotta/glass terracotta

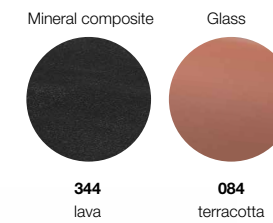

IZON Setting 03

1x 933050343 – Coffee table, Ø 111 cm Ø 43 3/4", lipari/talc
1x 929020133 – Side table, Ø 54,5 cm Ø 21 1/2", nori/glass nori



IZON Setting 05

1x 937050344 – Coffee table, Ø 111 cm Ø 43 3/4", black pepper/lava
1x 937070344 – Coffee table, 50 x 130 cm 19 3/4" x 51 1/4", black pepper/lava



IZON Setting 02

1x 913070306 – Coffee table, 50 x 130 cm 19 3/4" x 51 1/4", lipari/HPL lipari 2.0
1x 913020306 – Side table, Ø 54,5 cm Ø 21 1/2", lipari/HPL lipari 2.0



IZON Setting 04

1x 937030344 – Coffee table, 80 x 80 cm 31 1/2" x 31 1/2", black pepper/lava
1x 937060344 – Coffee table, 50 x 90 cm 19 3/4" x 35 1/2", black pepper/lava



IZON Setting 06

1x 933040343 – Coffee table, 120 x 120 cm 47 1/4" x 47 1/4", lipari/talc
1x 933070343 – Coffee table, 50 x 130 cm 19 3/4" x 51 1/4", lipari/talc



For further information please see DEDON.de/IZON



KIDA

Design by STEPHEN BURKS, 2021

Open, airy and inviting. A hanging lounge chair with a cradle-like organic form, wrapped in innovative DEDON Fiber Touch, and available in three colorways.



Hanging lounge chair glow touch
Cushion: COOL marsala
Base: nori

Typology

cm inch

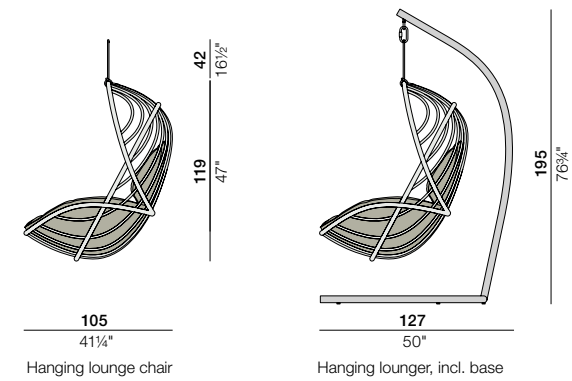

KIDA

Design by STEPHEN BURKS, 2021



Hanging lounge chair
ease touch, glow touch, dusk touch

RRP/UVF/PVPR

HANGING LOUNGE CHAIR*
Hängender Sessel*
Sillón colgante*

9,2 kg
21 lbs



111005

HANGING LOUNGE CHAIR
INCL. BASE*
Hängender Sessel, inkl. Standfuss*
Sillón colgante, incluida base*

28,9 kg
64 lbs



111008

EN *ATTENTION
Weight capacity 120 kg/265 lbs. Safety distance: base area of the stand.

DE *ACHTUNG
Tragkraft 120 kg/265 lbs. Sicherheitsabstand: Grundfläche des Standfußes.

ES *ATENCIÓN
Capacidad de carga 120 kg 265 lbs. Distancia de seguridad: Área de la base.

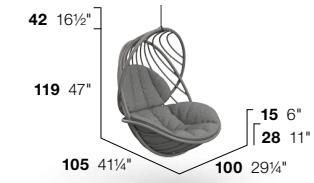

111005172

CUSHION
Kissen
Cojín



95111005 56111005000

CUSHION
Kissen
Cojín



95111005 56111005000

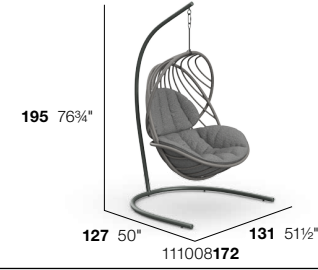

111008172

Materials

Recommended fabrics

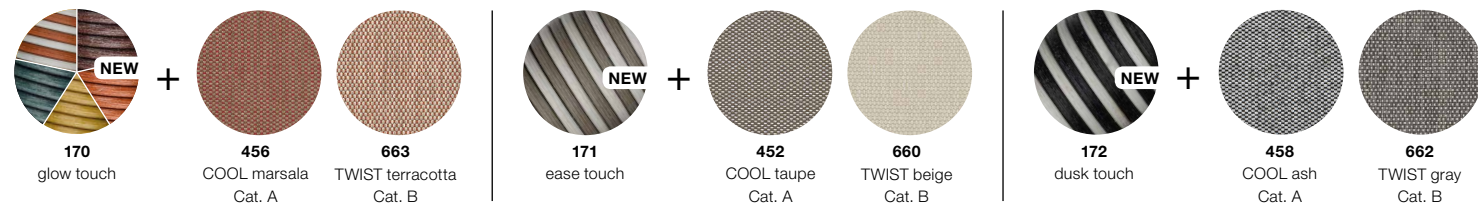

Powder coating base

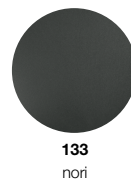

For further information please see [DEDON.de/KIDA](https://www.dedon.de/KIDA)



LOU

Design by TOAN NGUYEN, 2016

A contemporary modular lounge. Overlapping planes, semi-open weave and a floating structure convey lightness.



Right module
Center module
Corner module
Coffee table 126 cm 49½"
Tray
Cushion: COOL taupe

Typology

cm inch

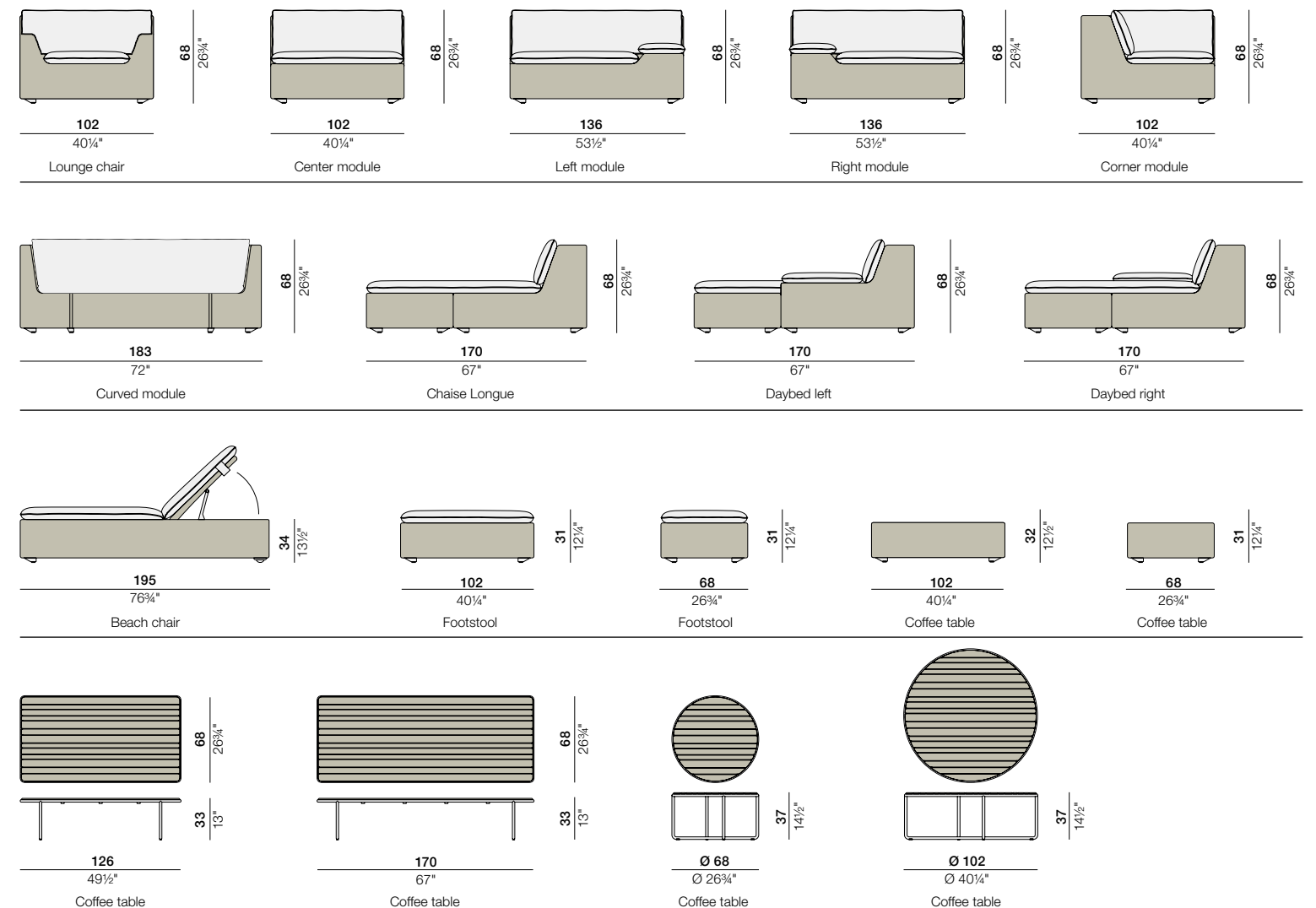

LOU

Design by TOAN NGUYEN, 2016



Right module
Coffee table 68 x 102 cm 26¾" x 40¼"
Curved module
Corner module
Coffee table 68 x 126 cm 26¾" x 49½"
Footstool 102 x 102 cm 40¼" x 40¼"
Cushion: COOL taupe

Materials

Combination

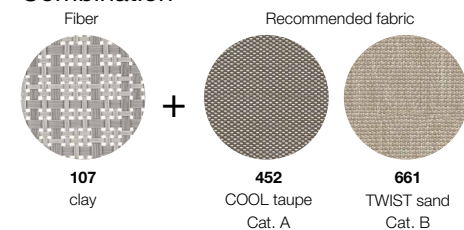

Tabletop ceramic



Tabletop teak



Powder coating

EN MATERIAL
The **LOU** collection includes two different types of **coffee tables**. One features a base woven with DEDON Fiber and a tabletop made of Monolite Ipergres®, a frost-proof ceramic material that is non-absorbing and highly resistant to indirect tensile stress, impacts, scratches and abrasions. The other table comes in two different shapes and four sizes, the round ones overlapping the square ones. These coffee tables feature a premium teak tabletop on a base of powder coated stainless steel. The **LOU tray** consists of cross-laminated teak veneer. To protect it from moisture, we recommend keeping it indoors when not in use.

DE MATERIAL
Für die **LOU** Kollektion stehen zwei verschiedene **Kaffeetische** zur Auswahl. Eine Version besteht aus einer mit DEDON-Faser geflochtenen Basis und einer Tischplatte aus Monolite Ipergres®, einem frostsicheren, wasserabweisenden Keramikmaterial mit ausgezeichneter Kratz- und Abriebfestigkeit. Der andere Tisch ist in zwei unterschiedlichen Formen und vier Größen erhältlich, wobei die runden die eckigen überlappen. Diese Kaffeetische bestehen aus einer hochwertigen Teakholz-Tischplatte und einem Gestell aus pulverbeschichtetem Edelstahl. Das **LOU Tablett** besteht aus Teak-Schichtholz. Um es vor Feuchtigkeit zu schützen, sollte es in Innenräumen aufbewahrt werden.

ES MATERIAL
La **colección LOU** dispone de dos versiones de **mesas de centro** diferentes. Una está realizada a base de tejido con fibra DEDON con un tablero hecho de Monolite Ipergres® es un material cerámico resistente a las heladas y hermético al agua, con una resistencia excelente contra los arañazos, la abrasión así como a la presión indirecta. La otra mesa se presenta en dos formas diferentes y cuatro tamaños en total, las mesas redondas se pueden colocar solapando las mesas rectangulares. Estas mesas de centro cuentan con un sobre de teca de alta calidad sobre una base de acero con acabado de pintura en polvo. La **bandeja LOU** se compone de chapa de madera de teca laminada. Para protegerla contra la humedad, le recomendamos que, cuando no se utilice, la guarde en un espacio cerrado.

RRP/UV/PVPR

LOUNGE CHAIR
Sessel
Sillón bajo

16 kg
36 lbs



107



079005107

SEAT CUSHION + BACK CUSHION
Sitzkissen + Rückenkissen
Cojín de asiento + Cojín de respaldo

68 x 68 cm + 102 x 38 cm
26¾" x 26¾" + 40¼" x 15"

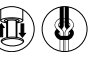

95079005



56079005000

CENTER MODULE
Modul mitte
Módulo centro

13 kg
29 lbs



107



079008107

SEAT CUSHION + BACK CUSHION
Sitzkissen + Rückenkissen
Cojín de asiento + Cojín de respaldo

102 x 68 cm + 102 x 38 cm
40¼" x 26¾" + 40¼" x 15"

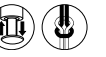

95079008



56079008000

LEFT MODULE
Modul links
Módulo izquierdo

16 kg
36 lbs



107



079007107

SEAT CUSHION + BACK CUSHION + SIDE CUSHION
Sitzkissen + Rückenkissen + Seitenkissen
Cojín de asiento + Cojín de respaldo + Cojín lateral

102 x 68 cm + 136 x 38 cm + 39 x 31 x 6 cm
40¼" x 26¾" + 53½" x 15" + 15¼" x 12¼" x 2¼"

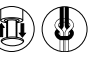

95079007



56079007000

RIGHT MODULE
Modul rechts
Módulo derecho

16 kg
36 lbs



107



079006107

SEAT CUSHION + BACK CUSHION + SIDE CUSHION
Sitzkissen + Rückenkissen + Seitenkissen
Cojín de asiento + Cojín de respaldo + Cojín lateral

102 x 68 cm + 136 x 38 cm + 39 x 31 x 6 cm
40¼" x 26¾" + 53½" x 15" + 15¼" x 12¼" x 2¼"

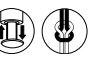

95079007



56079006000

CORNER MODULE
Eckmodul
Módulo esquina

14 kg
31 lbs



107



079009107

SEAT CUSHION + CORNER BACK CUSHION
Sitzkissen + Rückenkissen über Eck
Cojín de asiento + Cojín de respaldo de esquina

68 x 68 cm + 150 x 38 cm
26¾" x 26¾" + 59" x 15"



95079009



56079009000

CURVED MODULE
Bogenmodul
Módulo curvo

19 kg
42 lbs



107

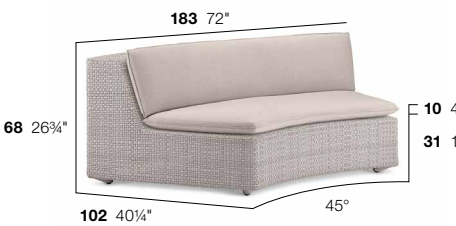

079010107

SEAT CUSHION + BACK CUSHION
Sitzkissen + Rückenkissen
Cojín de asiento + Cojín de respaldo

162 x 68 cm + 168 x 38 cm
63¾" x 26¾" + 66¼" x 15"



95079009



56079010000

CHAISE LONGUE
Chaise longue
Chaise longue

20 kg
45 lbs



107



079008107 + 079032107

SEAT CUSHION + BACK CUSHION
Sitzkissen + Rückenkissen
Cojín de asiento + Cojín de respaldo

102 x 138 cm + 102 x 38 cm
40¼" x 54¼" + 40¼" x 15"



95079002



56079002000

RRP/UVIP/PVPR

DAYBED LEFT
Daybed links
Daybed izquierdo



107

23 kg
51 lbs



SEAT CUSHION + BACK CUSHION + SIDE CUSHION
Sitzkissen + Rückenkissen + Seitenkissen
Cojin de asiento + Cojin de respaldo + Cojin lateral

102 x 136 cm + 136 x 38 cm + 39 x 31 x 6 cm
40 1/4\" x 53 1/2\" + 53 1/2\" x 15\" + 15 1/4\" x 12 1/4\" x 2 1/4\"



079007 + 079032

079007107 + 079032107

95079018

56079018000

DAYBED RIGHT
Daybed rechts
Daybed derecho



107

23 kg
51 lbs



SEAT CUSHION + BACK CUSHION + SIDE CUSHION
Sitzkissen + Rückenkissen + Seitenkissen
Cojin de asiento + Cojin de respaldo + Cojin lateral

102 x 136 cm + 136 x 38 cm + 39 x 31 x 6 cm
40 1/4\" x 53 1/2\" + 53 1/2\" x 15\" + 15 1/4\" x 12 1/4\" x 2 1/4\"



079006 + 079032

079006107 + 079032107

95079018

56079017000

BEACH CHAIR
Sonnenliege
Tumbona



107

19 kg
42 lbs



CUSHION
Kissen
Cojin

195 x 75 cm
76 3/4\" x 29 1/2\"



079119

079119107

95079119

56079119000

FOOTSTOOL
Hocker
Reposapiés



107

102 x 102 cm
8 kg
40 1/4\" x 40 1/4\"
18 lbs



SEAT CUSHION
Sitzkissen
Cojin de asiento

102 x 102 cm
40 1/4\" x 40 1/4\"



079031

079031107

95079031

56079031000

COFFEE TABLE
Kaffeetisch
Mesa de centro

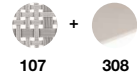

107

308

102 x 102 cm
47 kg
40 1/4\" x 40 1/4\"
104 lbs



SEAT CUSHION
Sitzkissen
Cojin de asiento

102 x 102 cm
40 1/4\" x 40 1/4\"



079030

079030107

95079030000

FOOTSTOOL
Hocker
Reposapiés



107

68 x 102 cm
7 kg
26 3/4\" x 40 1/4\"
16 lbs



SEAT CUSHION
Sitzkissen
Cojin de asiento

102 x 68 cm
40 1/4\" x 26 3/4\"

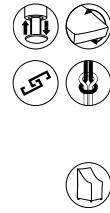

079032

079032107

95079032

56079032000

COFFEE TABLE
Kaffeetisch
Mesa de centro

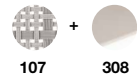

107

308

68 x 102 cm
26,5 kg
26 3/4\" x 40 1/4\"
59 lbs

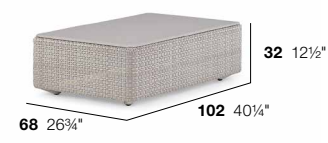

SEAT CUSHION
Sitzkissen
Cojin de asiento

102 x 68 cm
40 1/4\" x 26 3/4\"



079033

079033107

95079033000

RRP/UVIP/PVPR

RECOMMENDED DECO CUSHIONS
Empfohlene Dekokissen
Cojines decoración recomendados

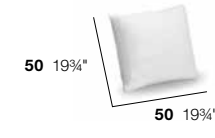

50 19 3/4\"

50 19 3/4\"

95050082

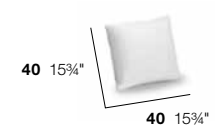

40 15 3/4\"

40 15 3/4\"

95050081

COFFEE TABLE
Kaffeetisch
Mesa de centro

68 x 126 cm
15,5 kg
26 3/4\" x 49 1/2\"
35 lbs



33 13\"

68 26 3/4\"

126 49 1/2\"

079035205



56079035000

079035

COFFEE TABLE
Kaffeetisch
Mesa de centro

68 x 170 cm
19 kg
26 3/4\" x 67\"
42 lbs



33 13\"

68 26 3/4\"

170 67\"

079037205



56079037000

079037

COFFEE TABLE
Kaffeetisch
Mesa de centro

Ø 68 cm
8,2 kg
Ø 26 3/4\"
19 lbs



37 14 1/2\"

Ø 68 Ø 26 3/4\"

079036205



56079036000

079036

COFFEE TABLE
Kaffeetisch
Mesa de centro

Ø 102 cm
15,3 kg
Ø 40 1/4\"
34 lbs



37 14 1/2\"

Ø 102 Ø 40 1/4\"

079034205



56079034000

079034

TRAY
Tablett
Bandeja



38 15\"

61 24\"

079099201



For further information please see DEDON.de/LOU

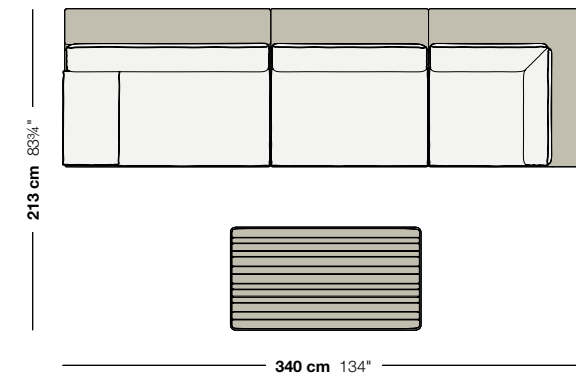

LOU Setting 01

- 1x **079006** – Right module, seat cushion + back cushion + side cushion
- 1x **079008** – Center module, seat cushion + back cushion
- 1x **079009** – Corner module, seat cushion + corner back cushion
- 1x **079035** – Coffee table 68 x 126 cm 26 3/4" x 49 1/2", teak top

Recommended deco cushions:

- 2x **95050081** – 40 x 40 cm 15 3/4" x 15 3/4"
- 1x **95050082** – 50 x 50 cm 19 3/4" x 19 3/4"

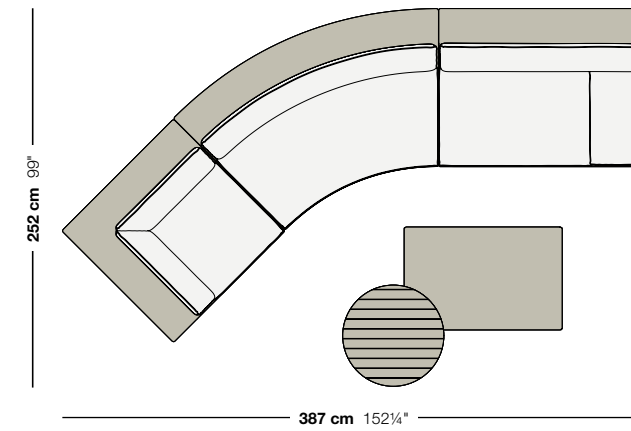

LOU Setting 02

- 1x **079009** – Corner module, seat cushion + corner back cushion
- 1x **079010** – Curved module, seat cushion + back cushion
- 1x **079007** – Left module, seat cushion + back cushion + side cushion
- 1x **079033** – Coffee table 68 x 102 cm 26 3/4" x 40 1/4", Monolite lpergres® taupe top
- 1x **079036** – Coffee table Ø 68 cm Ø 26 3/4", teak top

Recommended deco cushions:

- 2x **95050081** – 40 x 40 cm 15 3/4" x 15 3/4"
- 1x **95050082** – 50 x 50 cm 19 3/4" x 19 3/4"

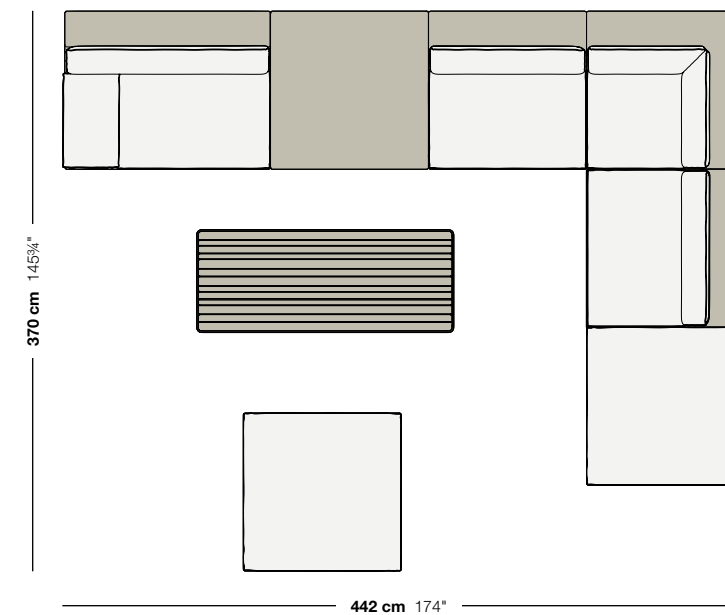

LOU Setting 03

- 1x **079006** – Right module, seat cushion + back cushion + side cushion
- 1x **079030** – Coffee table 102 x 102 cm 40 1/4" x 40 1/4", Monolite lpergres® taupe top
- 2x **079008** – Center module, seat cushion + back cushion
- 1x **079009** – Corner module, seat cushion + corner back cushion
- 2x **079031** – Footstool 102 x 102 cm 40 1/4" x 40 1/4", seat cushion
- 1x **079037** – Coffee table 68 x 170 cm 26 3/4" x 67", teak top

Recommended deco cushions:

- 3x **95050081** – 40 x 40 cm 15 3/4" x 15 3/4"
- 2x **95050082** – 50 x 50 cm 19 3/4" x 19 3/4"



LOUNGE

Design by FRANK LIGTHART, 2004

The original outdoor lounge system, now with curved modules. Minimalist design, thick cushions, a smart bracket solution for combining modules.



Corner module
Center module XXL
Left module & coffee table 110 x 110 cm 43¼" x 43¼"
taupe duet
Cushion: TWIST sand

Typology

cm inch

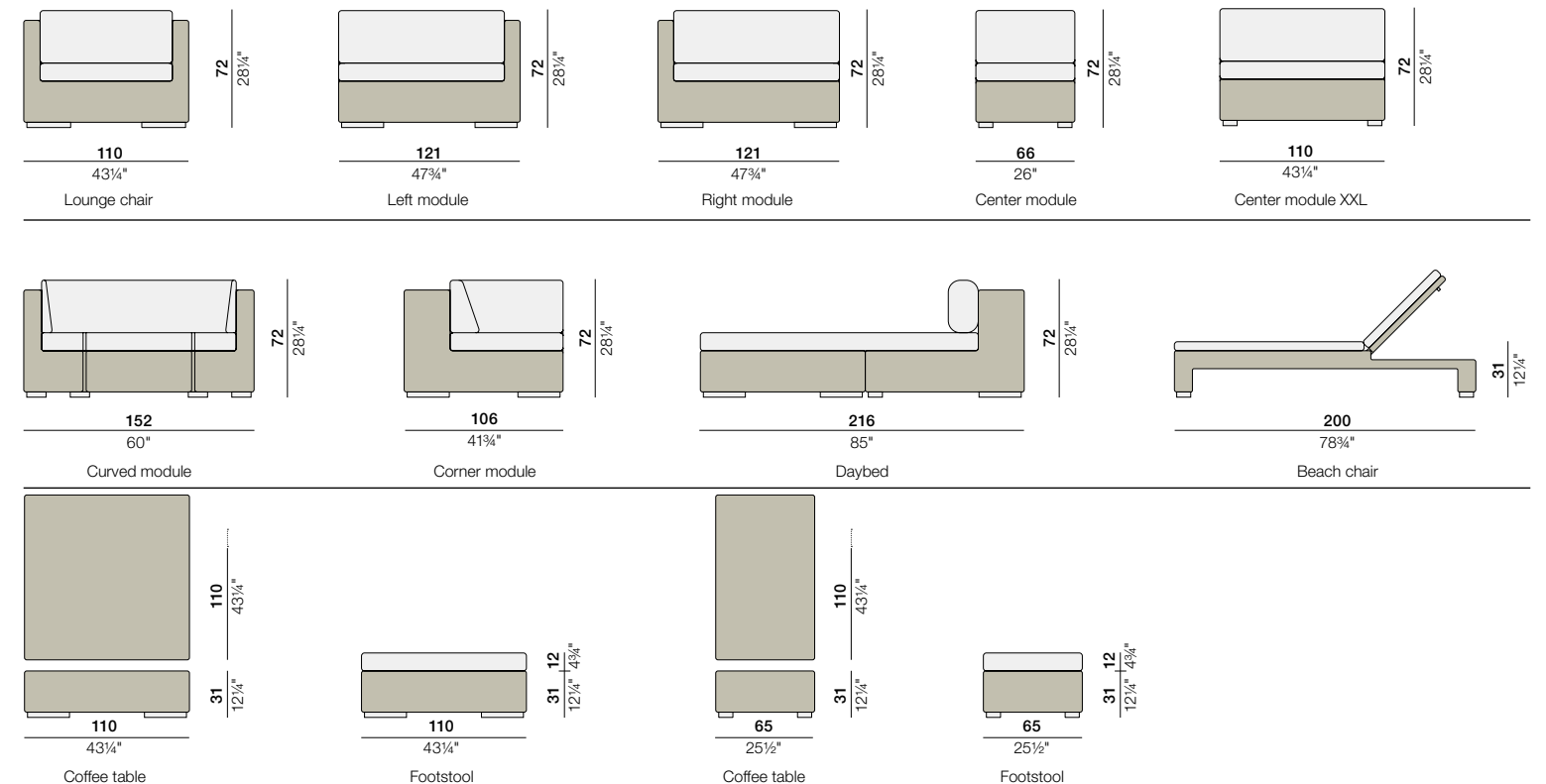

LOUNGE

Design by FRANK LIGTHART, 2004



Corner module bleach
Center module XXL bleach
Curved module bleach
Center module bleach
Cushion: COOL dark gray
Coffee table bleach 110 x 110 cm 43¼" x 43¼"

Materials

Fibers		Fibers		Fibers	
Fiber	Recommended fabric	Fiber	Recommended fabric	Fiber	Recommended fabric
018 java	452 COOL taupe Cat. A	366 taupe duet	455 COOL marengo Cat. A	066 bleach	454 COOL dark gray Cat. A
	660 TWIST beige Cat. B		661 TWIST sand Cat. B		660 TWIST beige Cat. B

Tabletop glass

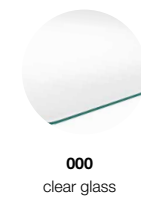

000
clear glass

EN DEDON Fiber
The DEDON Fiber taupe duet is made with a special injection-molding technique that unites two color tones in a vibrant way. Bleach is a fiber of natural color tones. Its subtle variations create a charming and lively look while ensuring that every piece of furniture woven with it is unique. Color differences within the fiber do not provide grounds for customer complaints.

DE DEDON Faser
Unsere zweifarbige DEDON-Faser in taupe duet wird in einem speziellen Spritzgussverfahren hergestellt, durch das eine lebhaft Verbindung von zwei Farbtönen entsteht. Bleach besteht aus zwei natürlichen Farbtönen, deren subtiles Farbenspiel innerhalb der Faserstruktur dem Möbel einen lebendigen Charme einhaucht. Dies ist der Grund dafür, dass jedes Möbelstück einzigartig ist und keines dem anderen gleicht. Farbunterschiede innerhalb der Faser sind daher kein Reklamationsgrund.

ES FIBRA DEDON
El tono taupe duet de la fibra DEDON está elaborado a partir de una técnica especial de moldeado por inyección, lo cual permite combinar dos colores obteniendo un resultado vibrante. La fibra bleach consiste en dos tonos naturales cuyas sutiles variaciones de colores dentro de la estructura de la fibra le dan al mueble un vivo encanto. Por esta razón cada pieza de mobiliario es única y no hay dos iguales. Las diferencias de color dentro de la fibra no son motivo de queja.

RRP/UVF/PVPR

LOUNGE CHAIR
Sessel
Sillón bajo

21 kg
47 lbs



PLUSH SEAT CUSHION + BACK CUSHION *
Plush Sitzkissen + Rückenkissen *
Plush cojín de asiento + Cojín de respaldo *

90 x 75 cm + 90 x 34 cm
35½" x 29½" + 35½" x 13½"



029008

LEFT MODULE
Modul links
Módulo izquierdo

19 kg
42 lbs

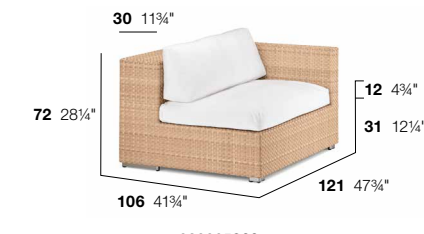

PLUSH SEAT CUSHION + BACK CUSHION *
Plush Sitzkissen + Rückenkissen *
Plush cojín de asiento + Cojín de respaldo *

111 x 75 cm + 111 x 34 cm
43¾" x 29½" + 43¾" x 13½"



029005

RIGHT MODULE
Modul rechts
Módulo derecho

19 kg
42 lbs

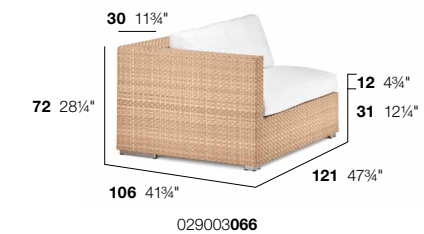

PLUSH SEAT CUSHION + BACK CUSHION *
Plush Sitzkissen + Rückenkissen *
Plush cojín de asiento + Cojín de respaldo *

111 x 75 cm + 111 x 34 cm
43¾" x 29½" + 43¾" x 13½"



029003

CENTER MODULE
Modul mitte
Módulo centro

11,5 kg
26 lbs

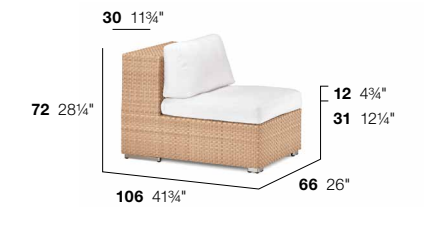

PLUSH SEAT CUSHION + BACK CUSHION *
Plush Sitzkissen + Rückenkissen *
Plush cojín de asiento + Cojín de respaldo *

66 x 75 cm + 66 x 34 cm
26" x 29½" + 26" x 13½"



029001

CENTER MODULE XXL
Modul mitte XXL
Módulo centro XXL

16 kg
36 lbs

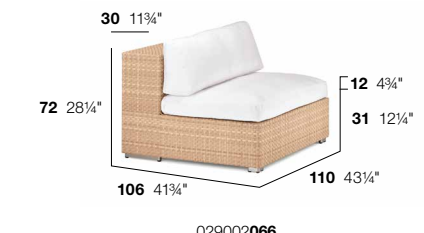

PLUSH SEAT CUSHION + BACK CUSHION *
Plush Sitzkissen + Rückenkissen *
Plush cojín de asiento + Cojín de respaldo *

110 x 75 cm + 110 x 34 cm
43¼" x 29½" + 43¼" x 13½"



029002

CURVED MODULE
Bogenmodul
Módulo curvo

16 kg
36 lbs

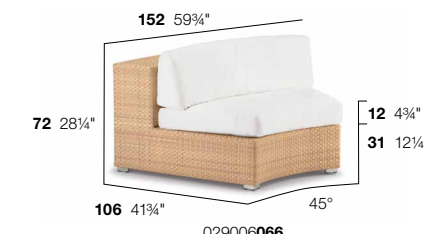
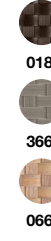

PLUSH SEAT CUSHION + BACK CUSHION *
Plush Sitzkissen + Rückenkissen *
Plush cojín de asiento + Cojín de respaldo *

127 x 83 cm + 127 x 34 cm
50" x 32¾" + 50" x 13½"



029006

RECOMMENDED DECO CUSHIONS
Empfohlene Dekokissen
Cojines decoración recomendados

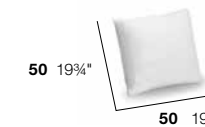

95050**082**

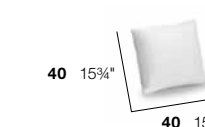

95050**081**

RRP/UVF/PVPR

CORNER MODULE

Eckmodul
Módulo esquina

18 kg
40 lbs



029007066

029007

PLUSH SEAT CUSHION + CORNER BACK CUSHION *
Plush Sitzkissen + Rückenkissen über Eck *
Plush cojín de asiento + Cojín de respaldo de esquina *

75 x 75 cm + 150 x 34 cm
29 1/2" x 29 1/2" + 59" x 13 1/2"



95029207 56029007000

PLUSH SEAT CUSHION + ONE-SIDED BACK CUSHION *
Plush Sitzkissen + 1-seitiges Rückenkissen *
Plush cojín de asiento + Cojín de respaldo de un lado *

75 x 75 cm + 75 x 34 cm
29 1/2" x 29 1/2" + 29 1/2" x 13 1/2"



95029217

FOOTSTOOL

Hocker
Reposapiés

110 x 110 cm
10,5 kg
43 1/4" x 43 1/4"
24 lbs

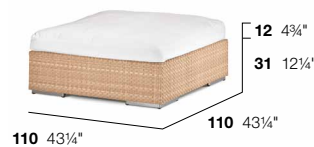

029037066

029037

PLUSH SEAT CUSHION
Plush Sitzkissen
Plush cojín de asiento

110 x 110 cm
43 1/4" x 43 1/4"



95029237 56029030000

COFFEE TABLE

Kaffeetisch
Mesa de centro

110 x 110 cm
28 kg
43 1/4" x 43 1/4"
62 lbs

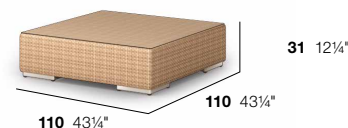
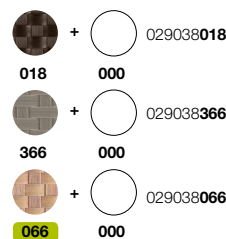

029038066

029038

PLUSH SEAT CUSHION
Plush Sitzkissen
Plush cojín de asiento

110 x 110 cm
43 1/4" x 43 1/4"



95029237 56029030000

FOOTSTOOL

Hocker
Reposapiés

65 x 110 cm
7 kg
25 1/2" x 43 1/4"
15 lbs



029035066

029035

PLUSH SEAT CUSHION
Plush Sitzkissen
Plush cojín de asiento

65 x 110 cm
25 1/2" x 43 1/4"



95029235 56029031000

COFFEE TABLE

Kaffeetisch
Mesa de centro

65 x 110 cm
17,5 kg
25 1/2" x 43 1/4"
38 lbs

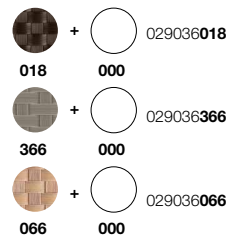

029036066

029036

PLUSH SEAT CUSHION
Plush Sitzkissen
Plush cojín de asiento

65 x 110 cm
25 1/2" x 43 1/4"



95029235 56029035000

* EN Back cushion DE Rückenkissen ES Cojín de respaldo

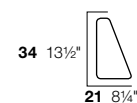

** EN Back cushion DE Rückenkissen ES Cojín de respaldo

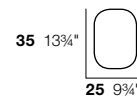

RRP/UVF/PVPR

DAYBED

Daybed
Daybed

26 kg
60 lbs



029002066 + 029037066

029002 + 029037

PLUSH SEAT CUSHION + BACK CUSHION
Plush Sitzkissen + Rückenkissen
Plush cojín de asiento + Cojín de respaldo

110 x 186 cm + 110 x 35 cm
43 1/4" x 73 1/4" + 43 1/4" x 13 3/4"



95029218

BEACH CHAIR

Sonnenliege
Tumbona

22,5 kg
50 lbs

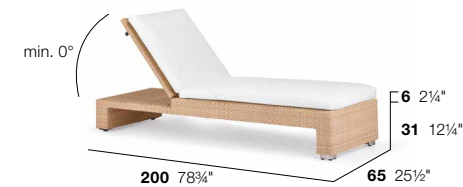

029119066

029119

PLUSH CUSHION
Plush Kissen
Plush cojín

65 x 190 cm
25 1/2" x 74 3/4"



95029219

56029019000

BEACH CHAIR

Sonnenliege
Tumbona

22,5 kg
50 lbs

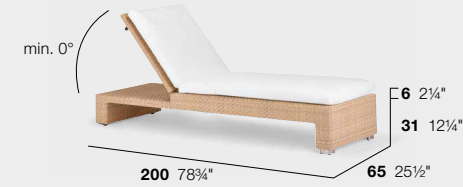
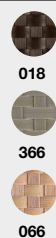

029919066

029919

PLUSH CUSHION
Plush Kissen
Plush cojín

65 x 190 cm
25 1/2" x 74 3/4"



95029219

029919



For further information please see DEDON.de/LOUNGE

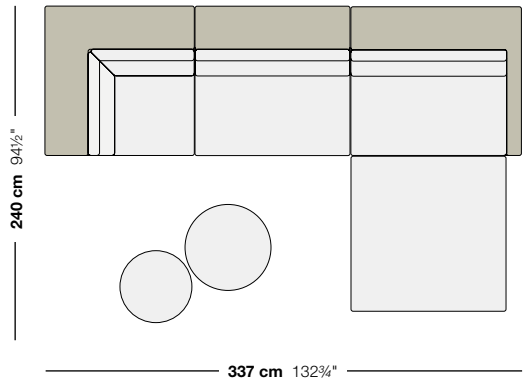

LOUNGE Setting 01

- 1x 029007 – Corner module, plush seat cushion + plush corner back cushion
- 1x 029002 – Center module XXL, plush seat cushion + plush back cushion
- 1x 029005 – Left module, plush seat cushion + plush back cushion
- 1x 029037 – Footstool 110 x 110 cm 43 1/4" x 43 1/4", plush seat cushion

- 1x 087034 – PORCINI side table
- 1x 087036 – PORCINI side table

Recommended deco cushions:
 4x 95050081 – 40 x 40 cm 15 3/4" x 15 3/4"
 3x 95050082 – 50 x 50 cm 19 3/4" x 19 3/4"

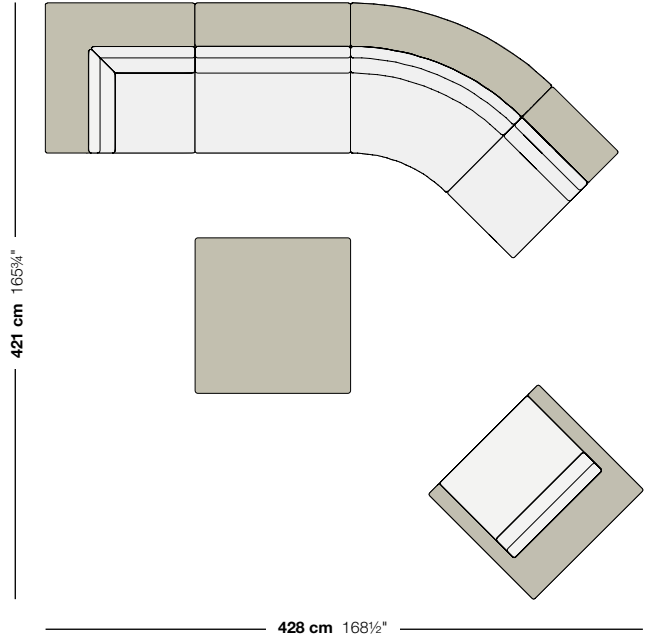

LOUNGE Setting 02

- 1x 029008 – Lounge chair, plush seat cushion + plush back cushion
- 1x 029001 – Center module, plush seat cushion + plush back cushion
- 1x 029006 – Curved module, plush seat cushion + plush back cushion
- 1x 029002 – Center module XXL, plush seat cushion + plush back cushion
- 1x 029007 – Corner module, plush seat cushion + plush corner back cushion
- 1x 029038 – Coffee table 110 x 110 cm 43 1/4" x 43 1/4", clear glass top

Recommended deco cushions:
 2x 95050081 – 40 x 40 cm 15 3/4" x 15 3/4"
 1x 95050082 – 50 x 50 cm 19 3/4" x 19 3/4"

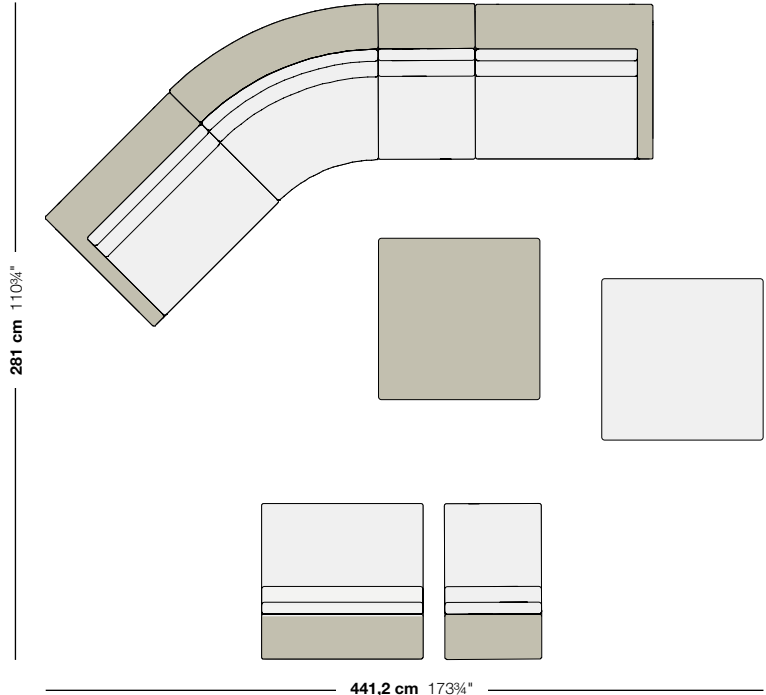

LOUNGE Setting 03

- 1x 029003 – Right module, plush seat cushion + plush back cushion
- 1x 029006 – Curved module, plush seat cushion + plush back cushion
- 2x 029001 – Center module, plush seat cushion + plush back cushion
- 1x 029005 – Left module, plush seat cushion + plush back cushion
- 1x 029038 – Coffee table 110 x 110 cm 43 1/4" x 43 1/4", clear glass top
- 1x 029037 – Footstool 110 x 110 cm 43 1/4" x 43 1/4", plush seat cushion
- 1x 029002 – Center module XXL, plush seat cushion + plush back cushion

Recommended deco cushions:
 3x 95050081 – 40 x 40 cm 15 3/4" x 15 3/4"
 2x 95050082 – 50 x 50 cm 19 3/4" x 19 3/4"



MBARQ

Design by SEBASTIAN HERKNER, 2020

The indoor alcove reimaged for outdoors. Deep seating and a choice of organically shaped backs that cocoon users in privacy and protective comfort.



3-seater, high backrest, chestnut
Cushion: TWIST terracotta
3 additional back cushions
MBRACE side tables

Typology

cm inch

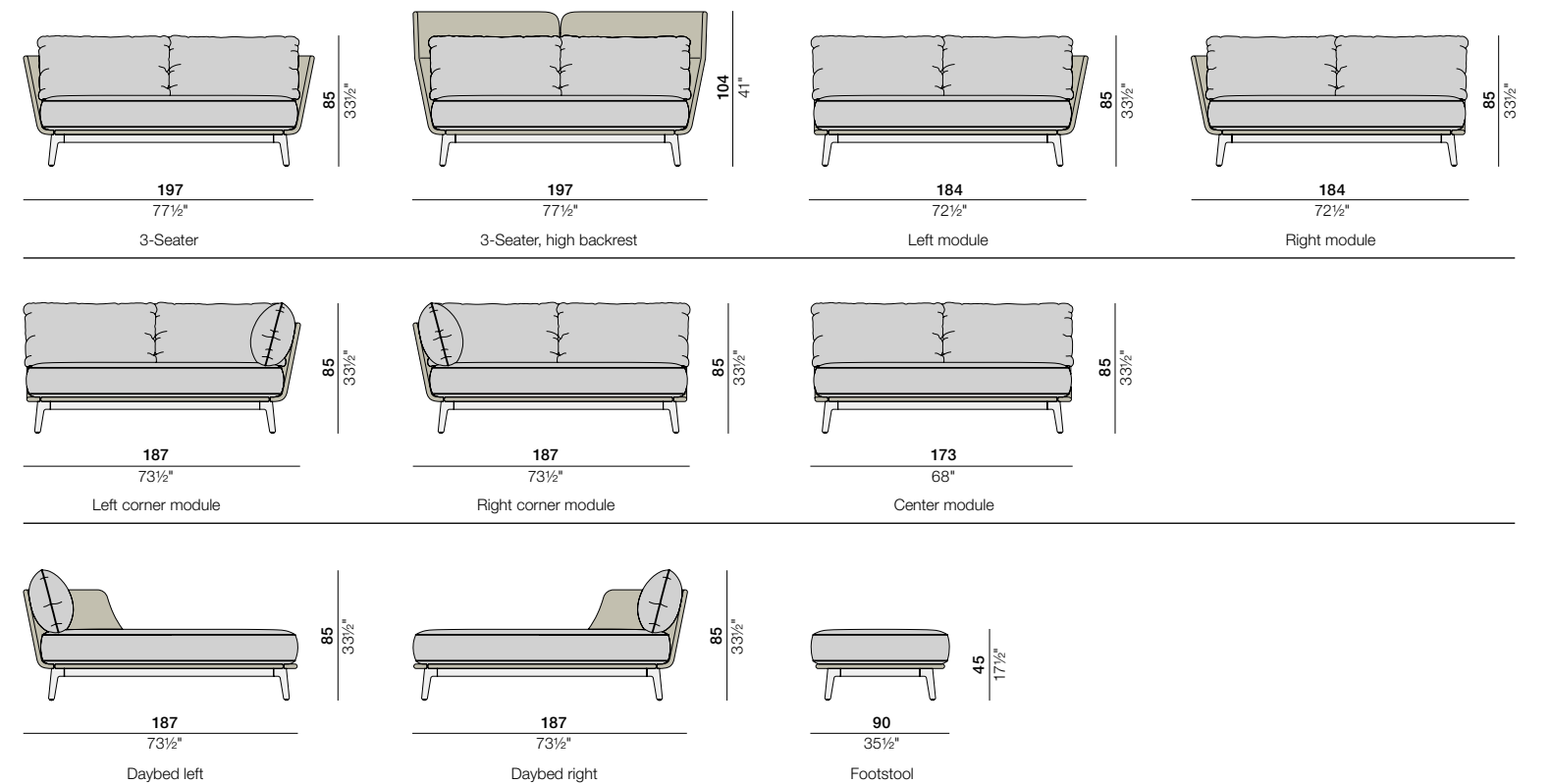

MBARQ

Design by SEBASTIAN HERKNER, 2020









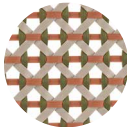

MBRACE wing chair alu base pepper
Cushion: TWIST sand
MBARQ 3-seater high backrest pepper
Cushion: TWIST sand
IZON coffee table lipari/talc 50 x 90 cm 19 3/4" x 35 1/2"

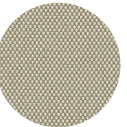
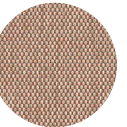

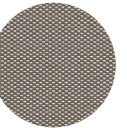
Materials

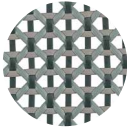
Combinations

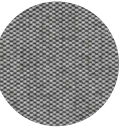
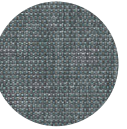
Fiber  151 chestnut	Powder coating  084 terracotta	+	Recommended fabrics  462 COOL sage Cat. A	 663 TWIST terracotta Cat. B
Fiber  115 pepper	Powder coating  304 lipari	+	Recommended fabrics  452 COOL taupe Cat. A	 661 TWIST sand Cat. B
Fiber  141 baltic	Powder coating  133 nori	+	Recommended fabrics  458 COOL ash Cat. A	 664 TWIST dark turquoise Cat. B

RRP/UVF/PVPR

3-SEATER
3er-Sofa
Sofá 3 plazas

23,6 kg
52 lbs



DRY+ CUSHION SET
Dry+ Kissenset
Dry+ Set de cojines

DRY+ ADDITIONAL BACK CUSHION
Dry+ zusätzliches Rückenkissen
Dry+ cojin de respaldo adicional

62 x 32 x 16 cm
24 1/2" x 12 1/2" x 6 1/4"

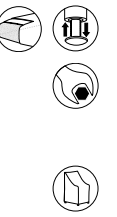

109015

109015115

95109215

3x 95109290

56109015000

3-SEATER, HIGH BACKREST
3-Sitzer, hohe Rückenlehne
Sofá 3 plazas, respaldo alto

28 kg
62 lbs

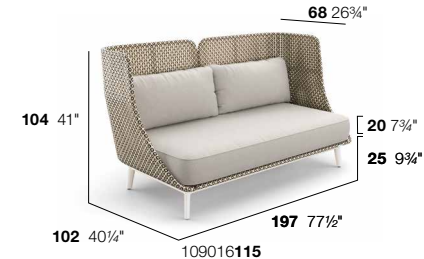

DRY+ CUSHION SET
Dry+ Kissenset
Dry+ Set de cojines

DRY+ ADDITIONAL BACK CUSHION
Dry+ zusätzliches Rückenkissen
Dry+ cojin de respaldo adicional

62 x 32 x 16 cm
24 1/2" x 12 1/2" x 6 1/4"

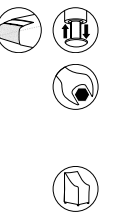

109016

109016115

95109215

3x 95109290

56109016000

LEFT MODULE
Modul links
Módulo izquierdo

22,7 kg
50 lbs



DRY+ CUSHION SET
Dry+ Kissenset
Dry+ Set de cojines

DRY+ ADDITIONAL BACK CUSHION
Dry+ zusätzliches Rückenkissen
Dry+ cojin de respaldo adicional

62 x 32 x 16 cm
24 1/2" x 12 1/2" x 6 1/4"

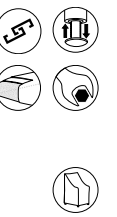

109005

109005115

95109215

3x 95109290

56109005000

RIGHT MODULE
Modul rechts
Módulo derecho

22,7 kg
50 lbs



DRY+ CUSHION SET
Dry+ Kissenset
Dry+ Set de cojines

DRY+ ADDITIONAL BACK CUSHION
Dry+ zusätzliches Rückenkissen
Dry+ cojin de respaldo adicional

62 x 32 x 16 cm
24 1/2" x 12 1/2" x 6 1/4"

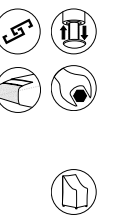

109003

109003115

95109215

3x 95109290

56109003000

LEFT CORNER MODULE
Eckmodul links
Módulo esquina izquierdo

23 kg
51 lbs



DRY+ CUSHION SET
Dry+ Kissenset
Dry+ Set de cojines

DRY+ ADDITIONAL BACK CUSHION
Dry+ zusätzliches Rückenkissen
Dry+ cojin de respaldo adicional

62 x 32 x 16 cm
24 1/2" x 12 1/2" x 6 1/4"

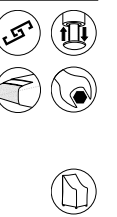

109006

109006115

95109204

3x 95109290

56109006000

RIGHT CORNER MODULE
Eckmodul rechts
Módulo esquina derecho

23 kg
51 lbs



DRY+ CUSHION SET
Dry+ Kissenset
Dry+ Set de cojines

DRY+ ADDITIONAL BACK CUSHION
Dry+ zusätzliches Rückenkissen
Dry+ cojin de respaldo adicional

62 x 32 x 16 cm
24 1/2" x 12 1/2" x 6 1/4"

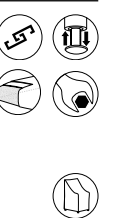

109004

109004115

95109204

3x 95109290

56109004000

EN DEDON FIBER

Die Möbel der MBARQ-Kollektion bestehen aus DEDON-Faser, die auf einem pulverbeschichteten Aluminiumrahmen geflochten ist. Für MBARQ verwenden wir dasselbe offene und lebendige, dreieckige Webmuster wie für unsere MBRACE-Serie. Einfach mit einem weichen Tuch und warmem Wasser zu reinigen.

DRY+ CUSHIONS

Dry+ cushions are protected by a highly water-repellent interlayer up to 10,000 mm. The fabric is treated to be stain- and water-repellent.

DE DEDON FASER

Los muebles de MBARQ-Kollektion bestehen aus DEDON-Faser, die auf einem pulverbeschichteten Aluminiumrahmen geflochten ist. Für MBARQ verwenden wir dasselbe offene und lebendige, dreieckige Webmuster wie für unsere MBRACE-Serie. Einfach mit einem weichen Tuch und warmem Wasser zu reinigen.

DRY+ KISSEN

Die Dry+ Kissen sind durch eine stark wasserabweisende innere Hülle mit einer Wassersäule von 10.000 mm geschützt. Der Stoff ist so behandelt, dass er schmutz- und wasserabweisend ist.

ES FIBRA DEDON

Los muebles de MBARQ están fabricados con fibra trenzada DEDON sobre una estructura de aluminio recubierto en polvo. MBARQ emplea el mismo y vibrante dibujo de trenzado triaxial que su primo, MBRACE. Limpiar con un paño suave y agua tibia.

DRY+ COJINES

Los cojines Dry+ están protegidos con un revestimiento muy impermeable con una resistencia al agua de nada menos que 10.000 mm. La tela está tratada para ser resistente a las manchas y al agua.

CENTER MODULE

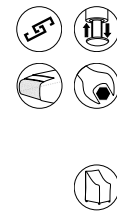
Modul mitte
Módulo centro21,8 kg
48 lbsDRY+ CUSHION SET
Dry+ Kissenset
Dry+ Set de cojinesDRY+ ADDITIONAL BACK CUSHION
Dry+ zusätzliches Rückenkissen
Dry+ cojín de respaldo adicional62 x 32 x 16 cm
24 1/2" x 12 1/2" x 6 1/4"

109001

109001115

95109215

3x 95109290

56109001000

DAYBED LEFT

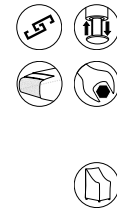
Daybed links
Daybed izquierdo18,2 kg
40 lbsDRY+ CUSHION SET
Dry+ Kissenset
Dry+ Set de cojinesDRY+ ADDITIONAL BACK CUSHION
Dry+ zusätzliches Rückenkissen
Dry+ cojín de respaldo adicional62 x 32 x 16 cm
24 1/2" x 12 1/2" x 6 1/4"

109017

109017115

95109217

95109290

56109017000

DAYBED RIGHT

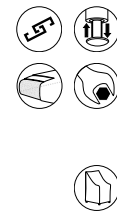
Daybed rechts
Daybed derecho18,2 kg
40 lbsDRY+ CUSHION SET
Dry+ Kissenset
Dry+ Set de cojinesDRY+ ADDITIONAL BACK CUSHION
Dry+ zusätzliches Rückenkissen
Dry+ cojín de respaldo adicional62 x 32 x 16 cm
24 1/2" x 12 1/2" x 6 1/4"

109018

109018115

95109217

95109290

56109018000

FOOTSTOOL

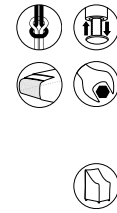
Hocker
Reposapiés13,7 kg
30 lbsDRY+ SEAT CUSHION
Dry+ Sitzkissen
Dry+ Cojín de asiento

109035

109035115

95109235

56109035000

MBARQ

OPTIONAL COMBINATIONS

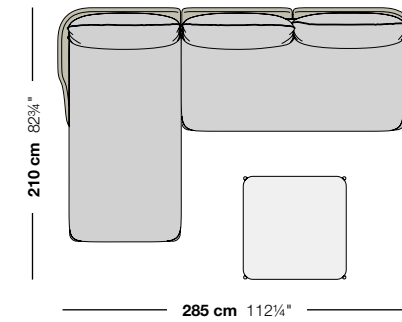

MBARQ Setting 01

1x 109018 – Daybed right, Dry+ cushion set
1x 109005 – Left module, Dry+ cushion set
4x 95109290 – Dry+ additional back cushions

1x 933030343 – IZON coffee table, 80 x 80 cm 31 1/2" x 31 1/2", lipari/talc

Recommended deco cushions:

2x 95050081 – 40 x 40 cm 15 3/4" x 15 3/4"
1x 95050082 – 50 x 50 cm 19 3/4" x 19 3/4"

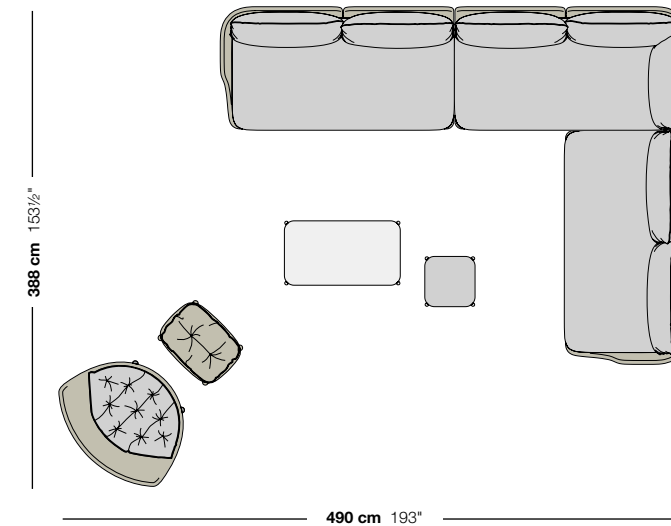

MBARQ Setting 02

1x 109003 – Right module, Dry+ cushion set
1x 109006 – Left corner module, Dry+ cushion set
1x 109005 – Left module, Dry+ cushion set
9x 95109290 – Dry+ additional back cushions

1x 937060344 – IZON coffee table, 50 x 90 cm 19 3/4" x 35 1/2", black pepper/lava
1x 926010084 – IZON side table, 39 x 39 cm 15 1/4" x 15 1/4", terracotta/glass terracotta

1x 085304 – MBRACE wing chair, alu base, seat cushion
1x 085332 – MBRACE footstool, alu base, seat cushion

Recommended deco cushions:

5x 95050081 – 40 x 40 cm 15 3/4" x 15 3/4"
4x 95050082 – 50 x 50 cm 19 3/4" x 19 3/4"

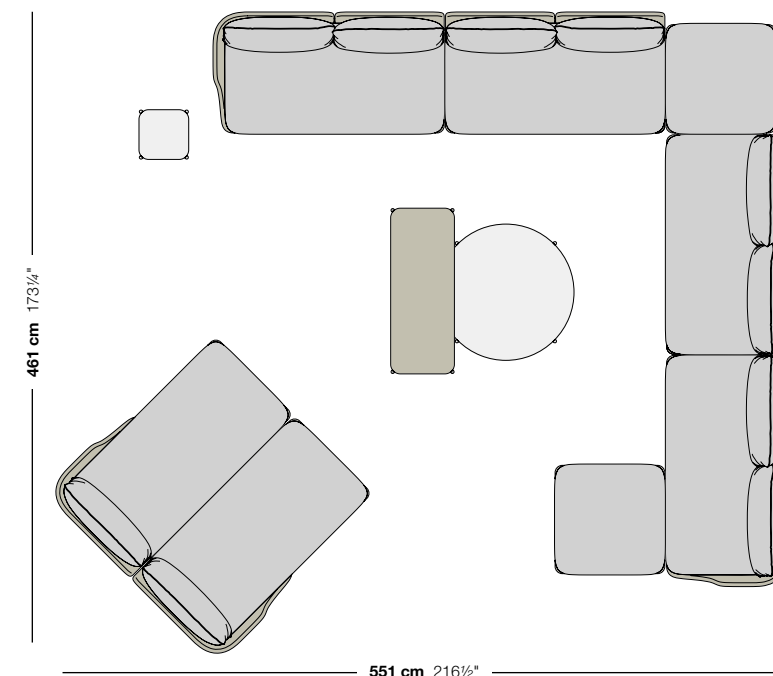

MBARQ Setting 03

1x 109003 – Right module, Dry+ cushion set
2x 109001 – Center module, Dry+ cushion set
1x 109005 – Left module, Dry+ cushion set
2x 109035 – Footstool, Dry+ seat cushion
1x 109018 – Daybed right, Dry+ cushion set
1x 109017 – Daybed left, Dry+ cushion set
15x 95109290 – Dry+ additional back cushions

1x 937050344 – IZON coffee table, Ø 111 cm Ø 43 3/4", black pepper/lava
1x 937070344 – IZON coffee table, 50 x 130 cm 19 3/4" x 51 1/4", black pepper/lava
1x 926010084 – IZON side table, 39 x 39 cm 15 1/4" x 15 1/4", terracotta/glass terracotta

Recommended deco cushions:

5x 95050081 – 40 x 40 cm 15 3/4" x 15 3/4"
4x 95050082 – 50 x 50 cm 19 3/4" x 19 3/4"

For further information please see [DEDON.de/MBARQ](https://www.dedon.de/MBARQ)



MBRACE

Design by SEBASTIAN HERKNER, 2016

Shapes that invite, cocoon, embrace. A lively material mix of fiber and premium teak. Triaxial weave in six vivid color combinations.



Armchair, sea salt
Cushion: TWIST sand
Optional back cushion: TWIST sand

Typology

cm inch



MBRACE

Design by SEBASTIAN HERKNER, 2016



Wing chair alu base pepper
Cushion: TWIST sand
Footstool alu base pepper

Materials

Recommended fabric combinations

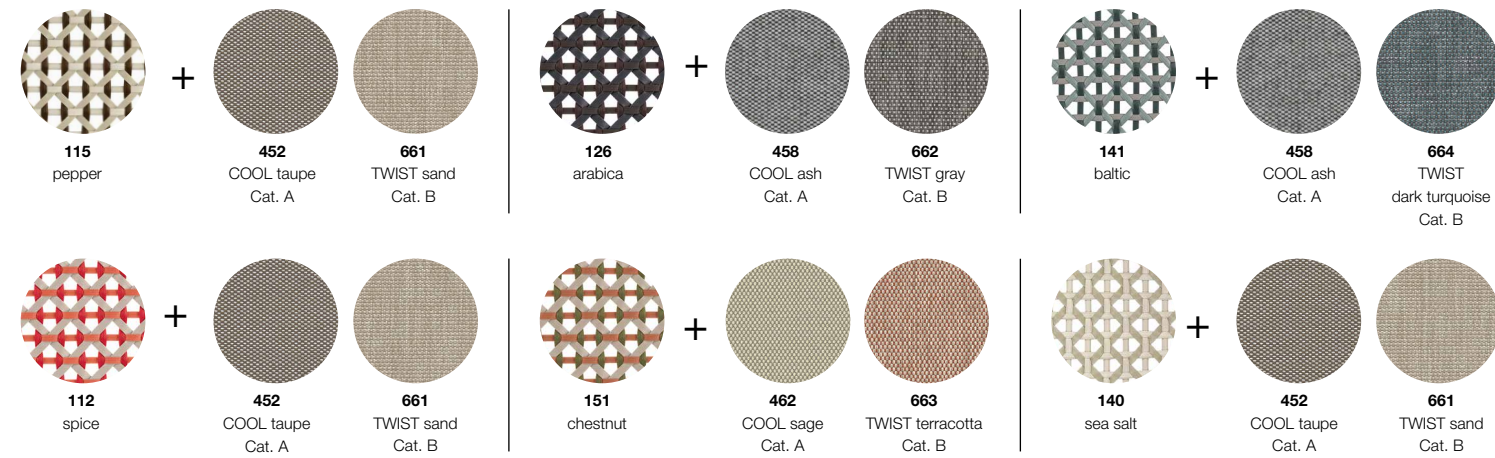

Alu-base combinations

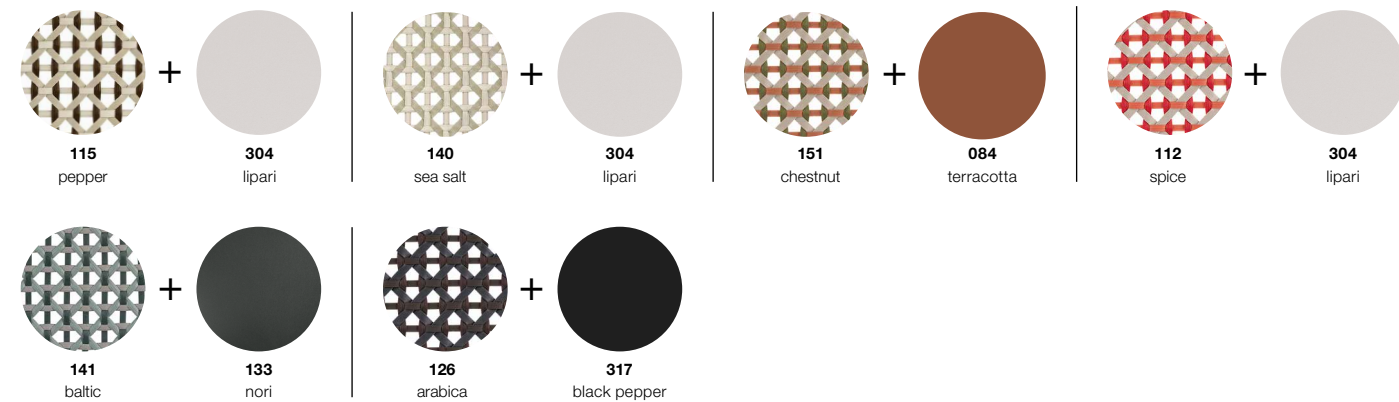

RRP/UVF/PVPR

WING CHAIR
Hochlehner
Sillón orejero

8,6 kg
19 lbs

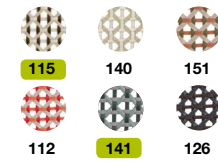

HEADREST CUSHION
Nackenkissen
Cojín reposacabezas

44 × 27 × 7,5 cm
37 1/2" × 25 1/2"

SEAT CUSHION
Sitzkissen
Cojín de asiento

95 × 65 cm
37 1/2" × 25 1/2"



085004

WING CHAIR
Hochlehner
Sillón orejero

13,5 kg
30 lbs

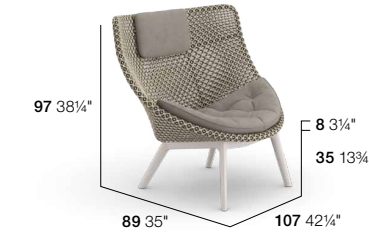
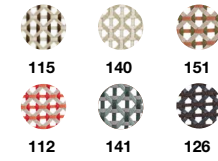

HEADREST CUSHION
Nackenkissen
Cojín reposacabezas

44 × 27 × 7,5 cm
37 1/2" × 25 1/2"

SEAT CUSHION
Sitzkissen
Cojín de asiento

95 × 65 cm
37 1/2" × 25 1/2"



085304

ROCKING CHAIR
Schaukelstuhl
Mecedora

9,9 kg
22 lbs

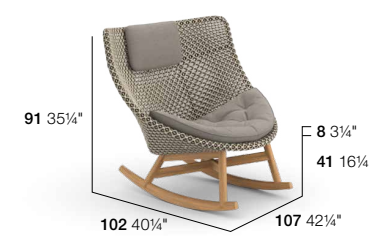
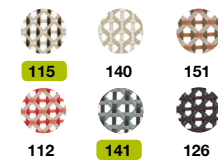

HEADREST CUSHION
Nackenkissen
Cojín reposacabezas

44 × 27 × 7,5 cm
37 1/2" × 25 1/2"

SEAT CUSHION
Sitzkissen
Cojín de asiento

95 × 65 cm
37 1/2" × 25 1/2"



085008

LOUNGE CHAIR
Sessel
Sillón bajo

7,5 kg
17 lbs

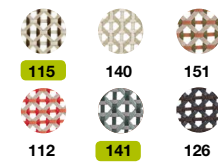

SEAT CUSHION
Sitzkissen
Cojín de asiento

95 × 65 cm
37 1/2" × 25 1/2"



085006

LOUNGE CHAIR
Sessel
Sillón bajo

12,4 kg
28 lb

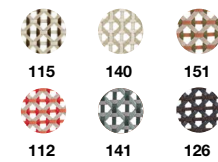

SEAT CUSHION
Sitzkissen
Cojín de asiento

95 × 65 cm
37 1/2" × 25 1/2"



085306

CUSHION OPTION
Kissen Optionen
Opciones de cojines



CUSHION
Polsterauflage
Cojín

105 × 140 cm
41 1/2" × 55"



CUSHION
Polsterauflage
Cojín

105 × 140 cm
41 1/2" × 55"



RECOMMENDED NUMBER OF DECO CUSHIONS FOR LOUNGE CHAIR, WING CHAIR AND ROCKING CHAIR WITH SEAT CUSHION.

Empfohlene Dekokissenmenge für Sessel, Hochlehner und Schaukelstuhl mit Sitzkissen.

Número de cojines decoración recomendados para sillón bajo, sillón orejero y mecedora con cojín de asiento.

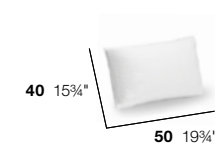

1 × 95050085

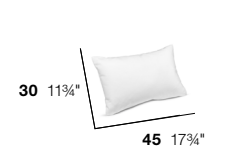

1 × 95050089

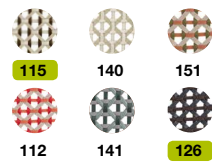
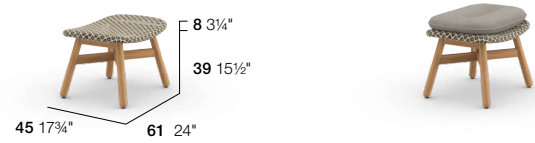
FOOTSTOOL
Hocker
Taburete3,8 kg
9 lbsSEAT CUSHION
Sitzkissen
Cojín de asiento62 x 45 cm
24 1/2" x 17 3/4"

085032

085032115

95085032

56085032000

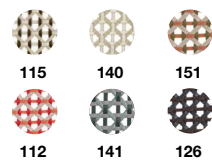
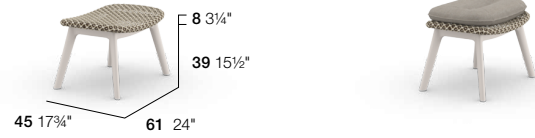
FOOTSTOOL
Hocker
Taburete8,8 kg
20 lbsSEAT CUSHION
Sitzkissen
Cojín de asiento62 x 45 cm
24 1/2" x 17 3/4"

085332

085332115

95085032

56085032000

DAYBED
Daybed
Daybed14,4 kg
32 lbsCUSHION
Polsterauflage
Cojín190 x 115 cm
74 3/4" x 45 1/4"

085018

0850181115

95085018

56085018000

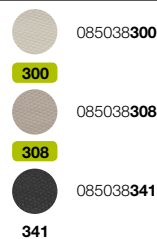
COFFEE TABLE
Kaffeetisch
Mesa de centroØ 70 cm
17,2 kg
Ø 27 1/2"
38 lbsØ 70 Ø 27 1/2"
085038308SEAT CUSHION
Sitzkissen
Cojín de asiento46,5 x 46,5 cm
18 1/4" x 18 1/4"

085038

085038308

56085038000

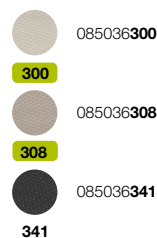
SIDE TABLE
Beistelltisch
Mesa auxiliarØ 50 cm
9,2 kg
Ø 19 3/4"
20 lbsØ 50 Ø 19 3/4"
085036308SEAT CUSHION
Sitzkissen
Cojín de asiento46,5 x 46,5 cm
18 1/4" x 18 1/4"

085036

085036308

56085036000

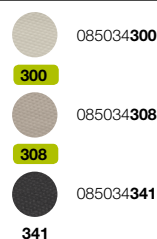
SIDE TABLE
Beistelltisch
Mesa auxiliarØ 35 cm
6,2 kg
Ø 13 3/4"
14 lbsØ 35 Ø 13 3/4"
085034308SEAT CUSHION
Sitzkissen
Cojín de asiento46,5 x 46,5 cm
18 1/4" x 18 1/4"

085034

085034308

56085034000

Tabletops ceramic

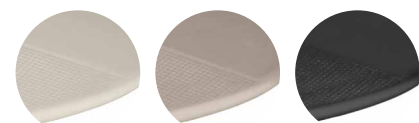

300

chalk

308

taupe

341

black

Tabletop



205

teak

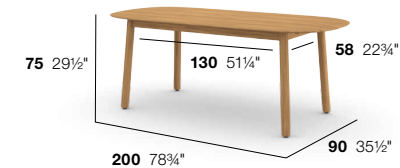
DINING TABLE
Esstisch
Mesa comedor200 x 90 cm
40 kg
35 1/2" x 78 3/4"
89 lbs

085065205

085065

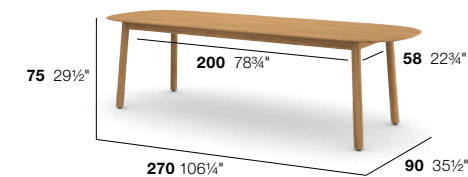
DINING TABLE
Esstisch
Mesa comedor270 x 90 cm
51 kg
35 1/2" x 106 1/4"
113 lbs

085055205

085055

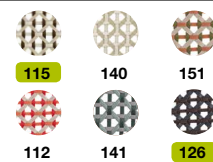
ARMCHAIR
Armlehnstuhl
Silla con brazos5,6 kg
13 lbs

085001115

085001

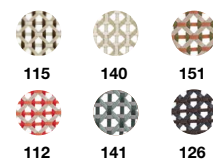
SEAT CUSHION
Sitzkissen
Cojín de asiento46,5 x 46,5 cm
18 1/4" x 18 1/4"OPTIONAL BACK CUSHION
Optionales Rückenissen
Cojín de respaldo opcional46 x 40 cm
18" x 15 3/4"ARMCHAIR
Armlehnstuhl
Silla con brazos8,2 kg
19 lbs

085301115

085301

SEAT CUSHION
Sitzkissen
Cojín de asiento46,5 x 46,5 cm
18 1/4" x 18 1/4"OPTIONAL BACK CUSHION
Optionales Rückenissen
Cojín de respaldo opcional46 x 40 cm
18" x 15 3/4"Available end of Q2/2021
Verfügbar ab Ende Q2/2021
Disponible desde finales del Q2/2021

085301

95085001

95103002

56085001000

EN MATERIAL

The MBRACE collection comes in a mix of materials. The seats consist of DEDON Fiber woven over an aluminum frame, while the bases and dining tables are made of premium teak. The wing chair, lounge chair, footstool and armchair are also available with a powder-coated, die-cast, single-piece aluminum base. The tabletops of the side tables are made of Monolite Ipergres®, a frost-proof ceramic material that is non-absorbing and highly resistant to indirect tensile stress, impacts, scratches and abrasion.

CUSHIONS

The cushions of the wing chair, lounge chair, rocking chair and daybed are quilted, which keeps the filling in place and supports the longevity of their luxurious embrace. While the covers cannot be removed, the cushions can be hand-washed at 30°C. The cushions for the wing chair, lounge chair, rocking chair and the armchair back cushion all come with a cushion holder, while seat cushions do not.

COVER

The protective cover is tailored to protect the fiber seat and cushions only.

DE MATERIAL

Die Kollektion MBRACE besteht aus einem Mix aus Materialien: Die Sitzflächen sind aus DEDON Faser gefertigt, die auf einem Aluminiumrahmen geflochten ist. Die Untergestelle und Esstische sind aus hochwertigem Teakholz gefertigt. Hochlehner, Sessel, Hocker und Armlehnstuhl kommen optional auch mit Untergestellen aus pulverbeschichtetem, in einem Stück druckgegossenem Aluminium. Die Tischplatten der Beistelltische werden aus Monolite Ipergres® gefertigt, einem frostsicheren, wasserabweisenden Keramikmaterial mit ausgezeichneter Kratz- und Abriebfestigkeit.

KISSEN

Die Kissen von Hochlehner, Sessel, Schaukelstuhl und Daybed sind gesteppt, um die weiche Füllung zu unterstützen. Daher können die Kissenhüllen nicht abgezogen werden, die kompletten Kissen können jedoch als Handwäsche bei 30°C gewaschen werden. Die Polsterauflagen von Hochlehner, Sessel und Schaukelstuhl sowie das Rückenissen vom Armlehnstuhl sind mit Kissenhaltern ausgestattet, die Sitzkissen nicht.

HUSSEN

Die Husse dient nur zum Schutz der geflochtenen Sitze und der Kissen.

ES MATERIAL

La colección MBRACE ofrece una interesante mezcla de materiales. La superficie de los asientos está fabricada con tejido trenzado DEDON sobre una estructura de aluminio, mientras que las bases y las mesas comedor son de teca de excelente calidad. El sillón orejero, el sillón bajo, el taburete y la silla con brazos están también disponibles con bases de aluminio de fundición con revestimiento de pintura en polvo. Los tableros de las mesas auxiliares están hechos de Monolite Ipergres®, un material de cerámica resistente a las heladas, no absorbente y que ofrece una excelente resistencia al peso, a los golpes, a los arañazos y a la abrasión.

COJINES

Los cojines de los sillones orejeros, sillones bajos, mecedoras y daybeds están capitonados, lo cual ayuda a mantener el suave relleno en su lugar y prolonga su comodidad. Si bien las fundas no son extraíbles, es posible lavar los cojines enteros a mano a 30 °C. Los cojines del respaldo de los sillones orejeros, bajos, mecedoras, así como de las sillas con brazos tienen un lazo para su sujeción, mientras que los cojines del asiento no lo tienen.

FUNDAS

La funda protectora está diseñada para proteger las sillas de fibra y los cojines.

For further information please see [DEDON.de/MBRACE](https://www.dedon.de/MBRACE)



MU

Design by TOAN NGUYEN, 2011

A modular lounge in a subtle mix of woven fiber, aluminum and high-end upholstery. Its name is a Zen term meaning 'reduced to pure essence'.



Right module XXL
Daybed left
Cushion: COOL taupe
Coffee table 90 x 90 cm
35½" x 35½"

Typology

cm inch

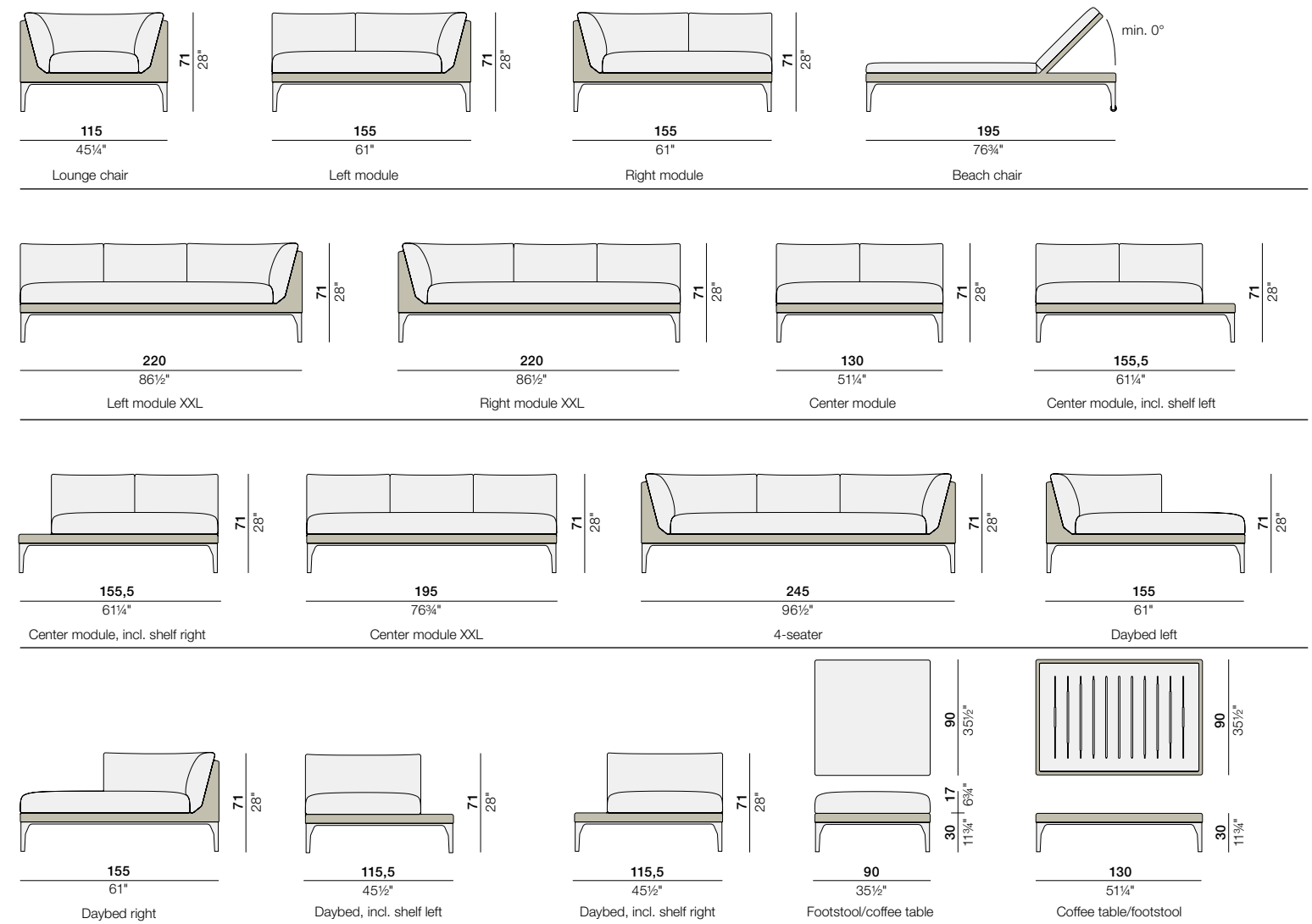

MU

Design by TOAN NGUYEN, 2011



Daybed, incl. shelf left, accona
Daybed, incl. shelf right, accona
Cushion: COOL taupe

Materials

Combinations

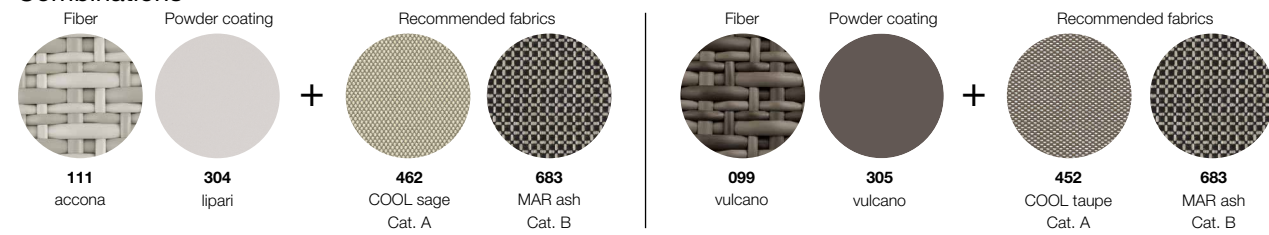

Tabletops HPL

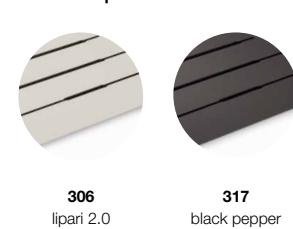

Tabletops glass

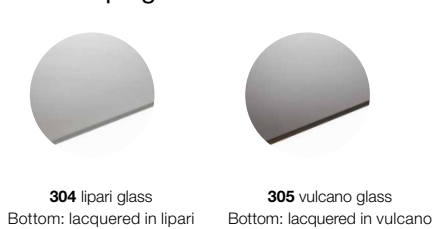

RRP/UVPR/PVPR

LOUNGE CHAIR

Sessel

Sillón bajo

28 kg
62 lbs



DRY+ SEAT CUSHION + DRY+ BACK CUSHION
Dry+ Sitzkissen + Dry+ Rückenkissen
Dry+ Cojín de asiento + Dry+ Cojín de respaldo

69 x 65 cm + 259 x 48 cm
27 1/4" x 25 1/2" + 102" x 19"



067001

067001099

95067201

56067001000

LEFT MODULE

Modul links

Módulo izquierdo

29 kg
64 lbs



DRY+ SEAT CUSHION + DRY+ BACK CUSHION
Dry+ Sitzkissen + Dry+ Rückenkissen
Dry+ Cojín de asiento + Dry+ Cojín de respaldo

132 x 65 cm + 228 x 48 cm
52" x 25 1/2" + 89 3/4" x 19"



067005

067005099

95067205

56067005000

RIGHT MODULE

Modul rechts

Módulo derecho

29 kg
64 lbs



DRY+ SEAT CUSHION + DRY+ BACK CUSHION
Dry+ Sitzkissen + Dry+ Rückenkissen
Dry+ Cojín de asiento + Dry+ Cojín de respaldo

132 x 65 cm + 228 x 48 cm
52" x 25 1/2" + 89 3/4" x 19"



067003

067003099

95067203

56067003000

LEFT MODULE XXL

Modul links XXL

Módulo izquierdo XXL

35 kg
78 lbs

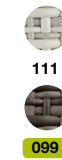

DRY+ SEAT CUSHION + DRY+ BACK CUSHION
Dry+ Sitzkissen + Dry+ Rückenkissen
Dry+ Cojín de asiento + Dry+ Cojín de respaldo

197 x 65 cm + 293 x 48 cm
77 1/2" x 25 1/2" + 115 1/4" x 19"



067006

067006099

95067206

56067006000

RIGHT MODULE XXL

Modul rechts XXL

Módulo derecho XXL

35 kg
78 lbs



DRY+ SEAT CUSHION + DRY+ BACK CUSHION
Dry+ Sitzkissen + Dry+ Rückenkissen
Dry+ Cojín de asiento + Dry+ Cojín de respaldo

197 x 65 cm + 293 x 48 cm
77 1/2" x 25 1/2" + 115 1/4" x 19"



067004

067004099

95067204

56067004000

CENTER MODULE

Modul mitte

Módulo centro

24 kg
53 lbs



DRY+ SEAT CUSHION + DRY+ BACK CUSHION
Dry+ Sitzkissen + Dry+ Rückenkissen
Dry+ Cojín de asiento + Dry+ Cojín de respaldo

130 x 65 cm + 130 x 48 cm
51 1/4" x 25 1/2" + 51 1/4" x 19"



067011

067011099

95067211

56067011000

CENTER MODULE, INCL. SHELF LEFT

Modul mitte, Ablage links

Módulo central, incluida repisa izquierda

27,5 kg
61 lbs



DRY+ SEAT CUSHION + DRY+ BACK CUSHION
Dry+ Sitzkissen + Dry+ Rückenkissen
Dry+ Cojín de asiento + Dry+ Cojín de respaldo

130 x 65 cm + 130 x 48 cm
51 1/4" x 25 1/2" + 51 1/4" x 19"



067122

067122099

95067211

56067022000

CENTER MODULE, INCL. SHELF RIGHT
Modul mitte, Ablage rechts
Módulo central, incluida repisa derecha

27,5 kg
61 lbs



DRY+ SEAT CUSHION + DRY+ BACK CUSHION
Dry+ Sitzkissen + Dry+ Rückenkissen
Dry+ Cojín de asiento + Dry+ Cojín de respaldo

130 x 65 cm + 130 x 48 cm
51 1/4\" x 25 1/2\" x 51 1/4\" x 19\"

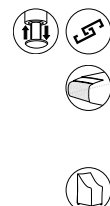

067123

067123099

95067211

56067023000

CENTER MODULE XXL
Modul mitte XXL
Módulo centro XXL

31 kg
69 lbs



DRY+ SEAT CUSHION + DRY+ BACK CUSHION
Dry+ Sitzkissen + Dry+ Rückenkissen
Dry+ Cojín de asiento + Dry+ Cojín de respaldo

195 x 65 cm + 195 x 48 cm
76 3/4\" x 25 1/2\" x 76 3/4\" x 19\"

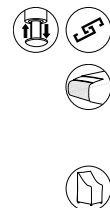

067012

067012099

95067212

56067012000

4-SEATER
4er-Sofa
Sofá 4 plazas

39 kg
86 lbs



DRY+ SEAT CUSHION + DRY+ BACK CUSHION
Dry+ Sitzkissen + Dry+ Rückenkissen
Dry+ Cojín de asiento + Dry+ Cojín de respaldo

199 x 65 cm + 390 x 48 cm
78 1/4\" x 25 1/2\" x 153 1/2\" x 19\"



067015

067015099

95067215

56067015000

DAYBED LEFT
Daybed links
Daybed izquierdo

28,5 kg
63 lbs



DRY+ SEAT CUSHION + DRY+ BACK CUSHION
Dry+ Sitzkissen + Dry+ Rückenkissen
Dry+ Cojín de asiento + Dry+ Cojín de respaldo

130 x 90 cm + 163 x 48 cm
51 1/4\" x 35 1/2\" x 64 1/4\" x 19\"



067017

067017099

95067217

56067017000

DAYBED RIGHT
Daybed rechts
Daybed derecho

28,5 kg
63 lbs

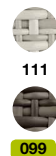

DRY+ SEAT CUSHION + DRY+ BACK CUSHION
Dry+ Sitzkissen + Dry+ Rückenkissen
Dry+ Cojín de asiento + Dry+ Cojín de respaldo

130 x 90 cm + 163 x 48 cm
51 1/4\" x 35 1/2\" x 64 1/4\" x 19\"



067018

067018099

95067218

56067018000

DAYBED, INCL. SHELF LEFT
Daybed, Ablage links
Daybed izquierdo, incluida repisa izquierda

36,4 kg
81 lbs



DRY+ SEAT CUSHION + DRY+ BACK CUSHION
Dry+ Sitzkissen + Dry+ Rückenkissen
Dry+ Cojín de asiento + Dry+ Cojín de respaldo

172 x 91,5 x 20 cm + 90 x 51 x 20 cm
67 3/4\" x 36\" x 7 3/4\" + 35 1/2\" x 20\" x 7 3/4\"



067124

067124099

95067224

56067024000

DAYBED, INCL. SHELF RIGHT
Daybed, Ablage rechts
Daybed derecho, incluida repisa derecha

36,4 kg
81 lbs



DRY+ SEAT CUSHION + DRY+ BACK CUSHION
Dry+ Sitzkissen + Dry+ Rückenkissen
Dry+ Cojín de asiento + Dry+ Cojín de respaldo

172 x 91,5 x 20 cm + 90 x 51 x 20 cm
67 3/4\" x 36\" x 7 3/4\" + 35 1/2\" x 20\" x 7 3/4\"



067125

067125099

95067224

56067025000

FOOTSTOOL
Hocker
Reposapiés

90 x 90 cm
18 kg
35 1/2\" x 35 1/2\"
40 lbs



DRY+ SEAT CUSHION
Dry+ Sitzkissen
Dry+ Cojín de asiento

90 x 90 cm
35 1/2\" x 35 1/2\"

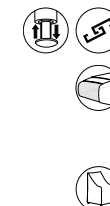

067016

067016099

95067216

56067030000

COFFEE TABLE
Kaffeetisch
Mesa de centro

90 x 90 cm
24,6 kg
35 1/2\" x 35 1/2\"
55 lbs

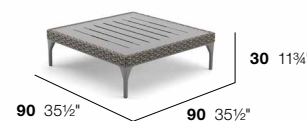

067116

067116099

56067016000

COFFEE TABLE
Kaffeetisch
Mesa de centro

90 x 90 cm
31,5 kg
35 1/2\" x 35 1/2\"
70 lbs

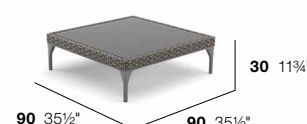

067216

067216099

56067016000

FOOTSTOOL
Hocker
Reposapiés

90 x 130 cm
22 kg
35 1/2\" x 51 1/4\"
49 lbs

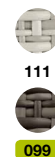

DRY+ SEAT CUSHION
Dry+ Sitzkissen
Dry+ Cojín de asiento

90 x 130 cm
35 1/2\" x 51 1/4\"

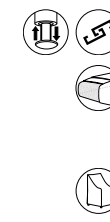

067013

067013099

95067213

56067031000

COFFEE TABLE
Kaffeetisch
Mesa de centro

90 x 130 cm
31,9 kg
35 1/2\" x 51 1/4\"
71 lbs

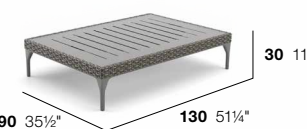

067113

067113099

56067013000

COFFEE TABLE
Kaffeetisch
Mesa de centro

90 x 130 cm
42 kg
35 1/2\" x 51 1/4\"
93 lbs

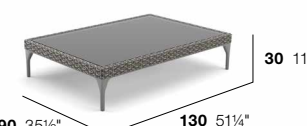

067213

067213099

56067013000

RECOMMENDED DECO CUSHIONS
Empfohlene Dekokissen
Cojines decoración recomendados

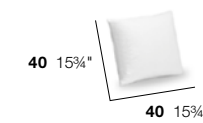
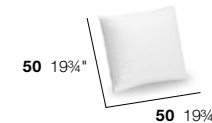

95050082

95050081

BEACH CHAIR
Sonnenliege
Tumbona



111

28,5 kg
63 lbs



099



067019099

DRY+ CUSHION
Dry+ Kissen
Dry+ Cojín



75 x 195 cm
29 1/2" x 76 3/4"



067019

95067219

56067019000

BEACH CHAIR
Sonnenliege
Tumbona



111

28,5 kg
63 lbs



099



067919099

DRY+ CUSHION
Dry+ Kissen
Dry+ Cojín



75 x 195 cm
29 1/2" x 76 3/4"



067919

95067219

56067019000

EN DRY+ CUSHIONS

Dry+ cushions are protected by a highly water-repellent interlayer up to 10,000 mm. The fabric is treated to be stain- and water-repellent.

DE DRY+ KISSEN

Die Dry+ Kissen sind durch eine stark wasserabweisende innere Hülle mit einer Wassersäule von 10.000 mm geschützt. Der Stoff ist so behandelt, dass er schmutz- und wasserabweisend ist.

ES DRY+ COJINES

Los cojines Dry+ están protegidos con un revestimiento muy impermeable con una resistencia al agua de nada menos que 10.000 mm. La tela está tratada para ser resistente a las manchas y al agua.

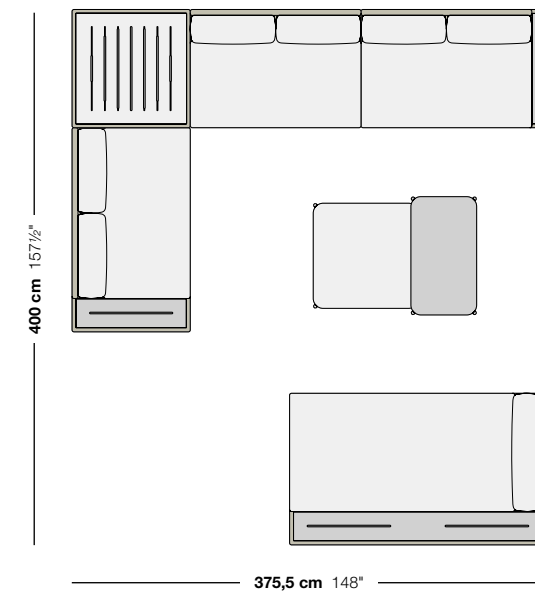
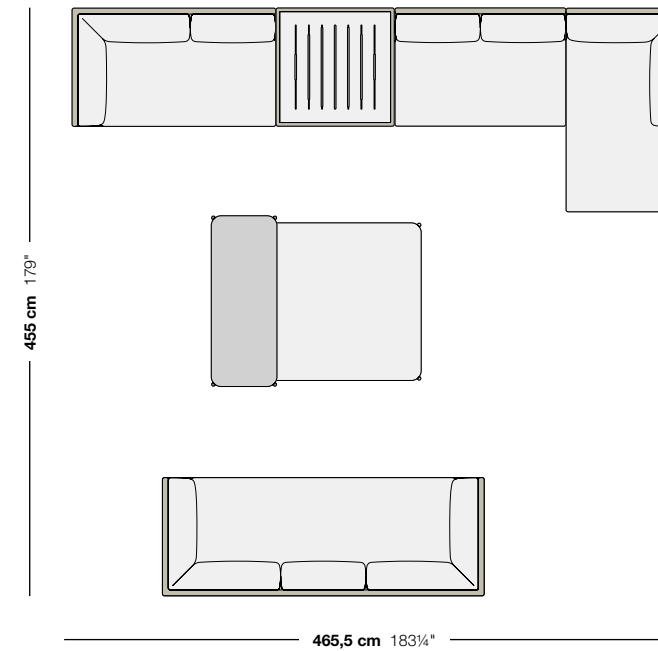
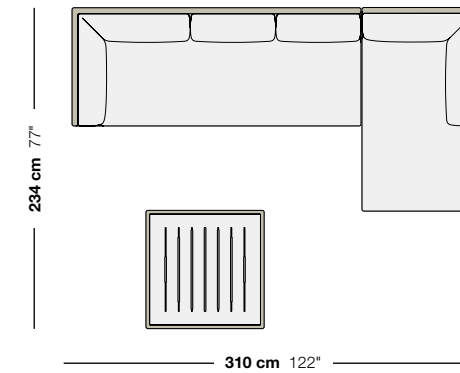
MU**OPTIONAL COMBINATIONS****MU Setting 01**

- 1x **067004** – Right module XXL, Dry+ seat cushion + Dry+ back cushions
- 1x **067017** – Daybed left, Dry+ seat cushion + Dry+ back cushion
- 1x **067116** – Coffee table 90 x 90 cm 35 1/2" x 35 1/2", HPL top

Recommended deco cushions:

- 2x **95050081** – 40 x 40 cm 15 3/4" x 15 3/4"
- 1x **95050082** – 50 x 50 cm 19 3/4" x 19 3/4"

MU Setting 02

- 1x **067003** – Right module, Dry+ seat cushion + Dry+ back cushions
- 1x **067116** – Coffee table 90 x 90 cm 35 1/2" x 35 1/2", HPL top
- 1x **067011** – Center module, Dry+ seat cushion + Dry+ back cushions
- 1x **067017** – Daybed left, Dry+ seat cushion + Dry+ back cushion
- 1x **067015** – 4-seater, Dry+ seat cushion + Dry+ back cushions

- 1x **933040343** – IZON coffee table, 120 x 120 cm 47 1/4" x 47 1/4", lipari/talc
- 1x **933070343** – IZON coffee table, 50 x 130 cm 19 3/4" x 51 1/4", lipari/talc

Recommended deco cushions:

- 6x **95050081** – 40 x 40 cm 15 3/4" x 15 3/4"
- 5x **95050082** – 50 x 50 cm 19 3/4" x 19 3/4"

MU Setting 03

- 1x **067123** – Center module, incl. shelf right, Dry+ seat cushion + Dry+ back cushions
- 1x **067116** – Coffee table 90 x 90 cm 35 1/2" x 35 1/2", HPL top
- 1x **067011** – Center module, Dry+ seat cushion + Dry+ back cushions
- 1x **067122** – Center module, incl. shelf left, Dry+ seat cushion + Dry+ back cushions
- 1x **067124** – Daybed, incl. shelf left, Dry+ seat cushion + Dry+ back cushion

- 1x **933030343** – IZON coffee table, 80 x 80 cm 31 1/2" x 31 1/2", lipari/talc
- 1x **937060344** – IZON coffee table, 50 x 90 cm 19 3/4" x 35 1/2", black pepper/lava

Recommended deco cushions:

- 4x **95050081** – 40 x 40 cm 15 3/4" x 15 3/4"
- 5x **95050082** – 50 x 50 cm 19 3/4" x 19 3/4"



For further information please see DEDON.de/MU



NESTREST

Design by DANIEL POUZET & FRED FRETZY, 2011

An icon of modern design. Inspired by nature, this is cocooning at its best—intimate, airy, perfect for dreaming or just being.



Standing lounger
Hanging lounger
Cushion: COOL white

Typology

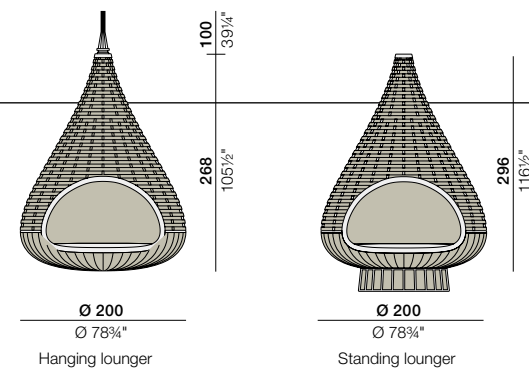

cm inch

NESTREST

Design by DANIEL POUZET & FRED FRETZY, 2011



Hanging lounger, natural
Cushion: COOL white

Materials

Combinations

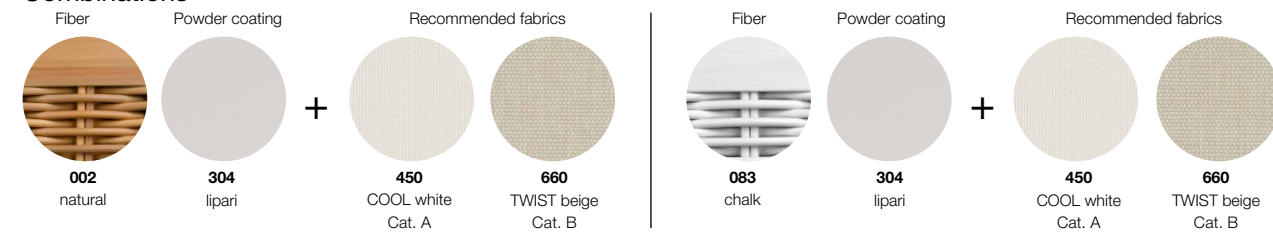

For further information please see DEDON.de/NESTREST

RRP/UVF/PVPR

HANGING LOUNGER
Hanging lounger
Hanging lounger

Ø 200 cm
85,5 kg
Ø 78¾"
189 lbs

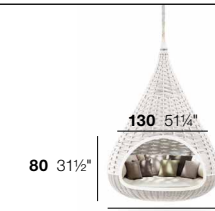

100 39¼"
268 105½"
80 31½"
130 51¼"
Ø 200 Ø 78¾"
090919083

SEAT CUSHION
Sitzkissen
Cojín de asiento
Ø 188 x 13,5 cm
Ø 74" x 5¼"



090919

STANDING LOUNGER, INCL. BASE
Standing lounger, inkl. Untersatz
Standing lounger, base incl.

Ø 200 cm
99,5 kg
Ø 78¾"
220 lbs

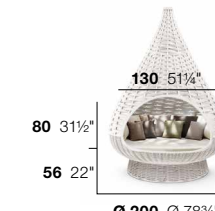

130 51¼"
268 105½"
80 31½"
56 22"
28 11"
Ø 200 Ø 78¾"
090023083

SEAT CUSHION
Sitzkissen
Cojín de asiento
Ø 188 x 13,5 cm
Ø 74" x 5¼"

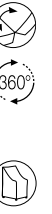

090023

BASE, SUITABLE FOR HANGING AND STANDING LOUNGER
Untersatz, passend für Hanging und Standing lounger
Base, adaptable para el hanging y standing lounger

14 kg
31 lbs

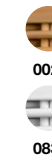

95090219
6600000863



090018

TETHERING ROPE
Bodenbefestigung
Opciones de sujeción

1,4 kg
3,5 lbs



23091005009

RECOMMENDED NUMBER OF DECO CUSHIONS
Empfohlene Dekokissenmenge
Número de Cojines decoración recomendados

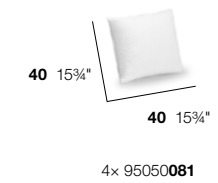
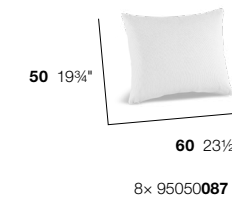

EN ATTENTION

Hanging and standing lounger do not fit through standard doors!
Weight capacity: 350 kg/770 lbs.

COVERS

Cover is tailored to protect seat and deco cushions only.

DE ACHTUNG

Hanging und Standing Lounger passen nicht durch Türen mit Standardabmessungen!
Tragkraft: 350 kg/770 lbs.

HUSSEN

Die Husse dient nur zum Schutz der Sitzfläche und der Dekokissen.

ES ATENCIÓN

Debido a las dimensiones de este producto se recomienda verifiquen la accesibilidad!
Capacidad de carga: 350 kg/770 lbs.

FUNDAS

La funda está confeccionada para proteger el asiento y los cojines decorativos únicamente.

EN The NESTREST is shipped with pre-mounted handles.

DE Das NESTREST wird inkl. vormontierter Griffe geliefert.

ES El NESTREST se entrega con asas de transporte desmontables.



For more NESTREST products see page 188



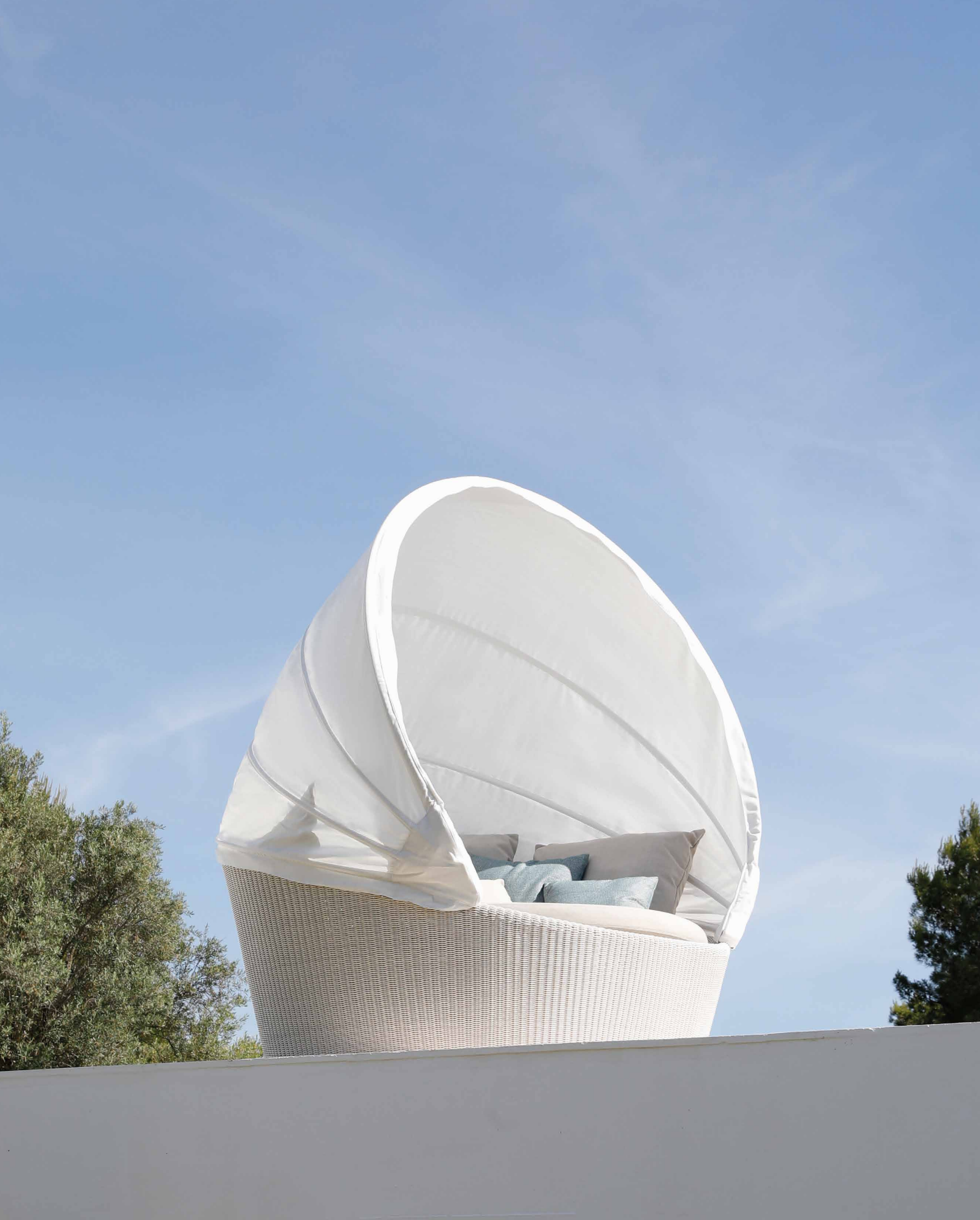

ORBIT

Design by RICHARD FRINIER, 2002

The original outdoor classic. Generously proportioned and luxuriously comfortable. Easy to move and rotate with the sun. Shady cloth canopy, easily opened or closed.



Loveseat XXL, chalk
Canopy: taupe
Cushion: COOL taupe

Typology

cm inch

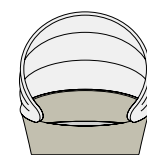

Ø 165
Ø 65"

Loveseat

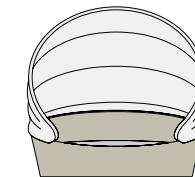
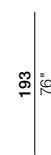

Ø 220
Ø 86½"

Loveseat XXL

183

76"

215

84¾"

ORBIT

Design by RICHARD FRINIER, 2002



Loveseat, accona
Cushion: COOL white

Materials

Recommended combinations

<p>Fiber</p> <p>040 bronze</p>	+	<p>Recommended fabrics</p> <p>450 COOL white Cat. A</p>	+	<p>661 TWIST sand Cat. B</p>
<p>Fiber</p> <p>083 chalk</p>	+	<p>Recommended fabrics</p> <p>452 COOL taupe Cat. A</p>	+	<p>662 TWIST gray Cat. B</p>
<p>Fiber</p> <p>099 vulcano</p>	+	<p>Recommended fabrics</p> <p>452 COOL taupe Cat. A</p>	+	<p>683 MAR ash Cat. B</p>
<p>Fiber</p> <p>111 accona</p>	+	<p>Recommended fabrics</p> <p>462 COOL sage Cat. A</p>	+	<p>683 MAR ash Cat. B</p>



For further information please see DEDON.de/ORBIT

RRP/UVF/PVPR

LOVESEAT
Sofainset
Sofá isla

42,5 kg
94 lbs
030005040 **030005083**

Ø 165 cm
Ø 65"

32 kg
71 lbs
030008099 **030008111**

193 76"



Ø 165 Ø 65"
030005083

SEAT CUSHION
Sitzkissen
Cojín de asiento

Ø 127 cm
Ø 50"

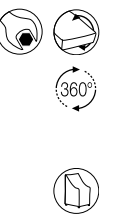

95030001

56030003000

RECOMMENDED NUMBER OF DECO CUSHIONS

Empfohlene Dekokissenmenge

Número de Cojines decoración recomendados

<p>70 27 1/2"</p> <p>70 27 1/2"</p> <p>2x 95050086</p>	<p>60 23 1/2"</p> <p>60 23 1/2"</p> <p>2x 95050084</p>	<p>50 19 3/4"</p> <p>50 19 3/4"</p> <p>2x 95050082</p>	<p>40 15 3/4"</p> <p>40 15 3/4"</p> <p>2x 95050081</p>
---	---	---	---

LOVESEAT XXL
Sofainset XXL
Sofá isla XXL

69 kg
153 lbs
030006040 **030911083**

Ø 220 cm
Ø 86 1/2"

89 kg
197 lbs
030011099 **030011111**

215 84 3/4"



Ø 220 Ø 86 1/2"
030911083

SEAT CUSHION
Sitzkissen
Cojín de asiento

Ø 184 cm
Ø 72 1/2"

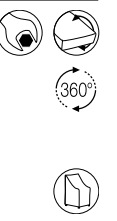

95030004

56030006000

LOVESEAT XXL
Sofainset XXL
Sofá isla XXL

69 kg
153 lbs
030006083

Ø 220 cm
Ø 86 1/2"

89 kg
197 lbs
030111111

215 84 3/4"



Ø 220 Ø 86 1/2"
030006083

SEAT CUSHION
Sitzkissen
Cojín de asiento

Ø 184 cm
Ø 72 1/2"

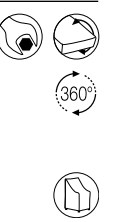

95030004

56030006000

RECOMMENDED NUMBER OF DECO CUSHIONS

Empfohlene Dekokissenmenge

Número de Cojines decoración recomendados

<p>70 27 1/2"</p> <p>70 27 1/2"</p> <p>4x 95050086</p>	<p>60 23 1/2"</p> <p>60 23 1/2"</p> <p>4x 95050084</p>	<p>50 19 3/4"</p> <p>50 19 3/4"</p> <p>2x 95050082</p>	<p>40 15 3/4"</p> <p>40 15 3/4"</p> <p>2x 95050081</p>
---	---	---	---

EN MATERIAL

ORBIT with lipari or vulcano fiber comes with a seat consisting of sling material.

DE MATERIAL

Bei ORBIT in lipari und vulcano Faser besteht die Sitzfläche unter dem Sitzkissen aus Sling Material.

ES MATERIAL

Los asientos de ORBIT de fibra lipari o vulcano están compuestos de material de tensor.

EN The loveseat / loveseat XXL is shipped with pre-mounted pullout casters.

DE Die Sofainset / Sofainset XXL wird inkl. vormontierter ausklappbarer Räder geliefert.

ES El sofá isla / El sofá isla XXL se entrega con ruedas premontadas plegables.





PANAMA

Design by RICHARD FRINIER, 2002

Warm and inviting. Flowing lines and gently flaring curves.
A wide range of pieces, for every outdoor need.



Armchair
Side chair
Cushion: TWIST gray

Typology

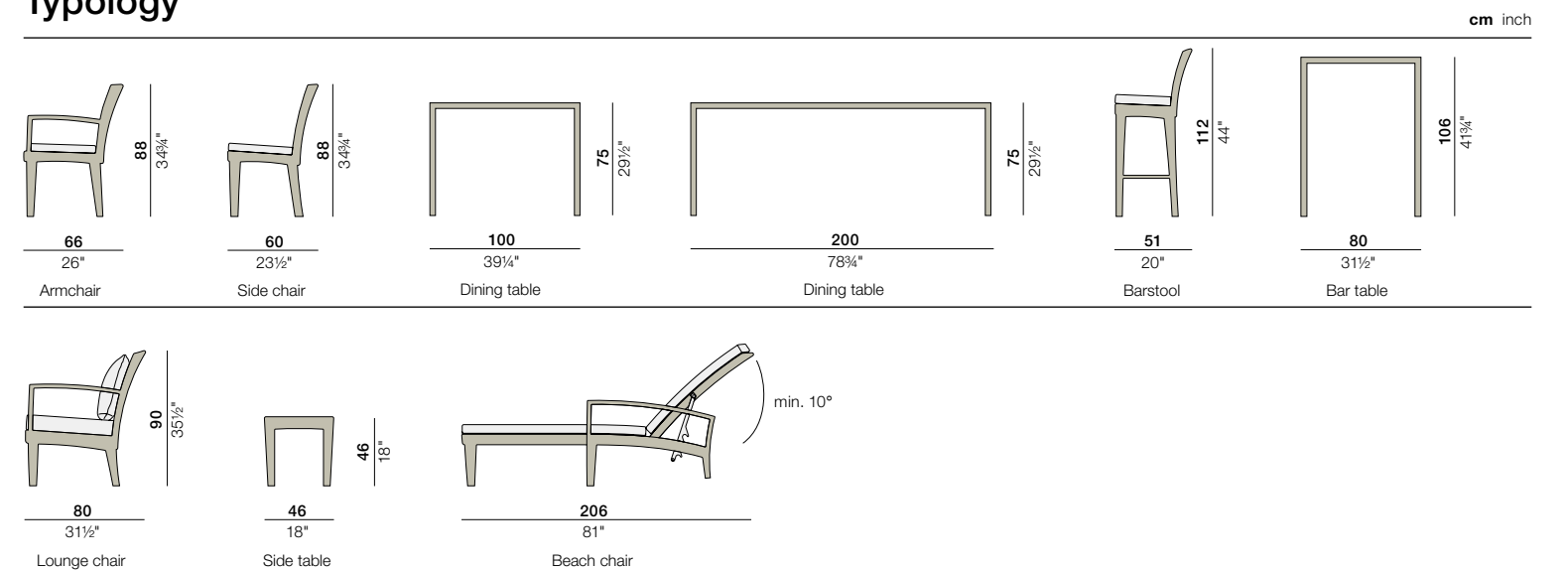

PANAMA

Design by RICHARD FRINIER, 2002



Beach chair, bronze
Cushion: COOL white

Materials

Recommended combinations

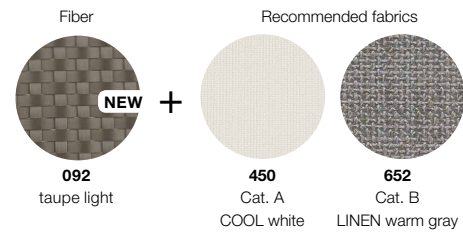
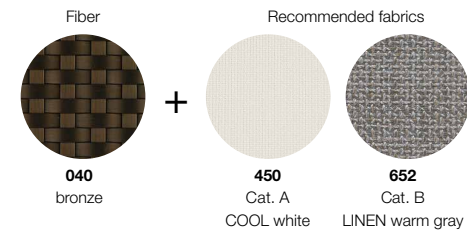

Tabletops glass



For further information please see DEDON.de/PANAMA

RRP/UVF/PVPR

SIDE CHAIR
Esstuhl
Silla de comedor

5 kg
12 lbs



022003

022003092

SEAT CUSHION
Sitzkissen
Cojín de asiento

46 x 44 cm
18" x 17 1/4"

95022003

56022003000

ARMCHAIR
Armlehnstuhl
Silla con brazos

7 kg
16 lbs



022001

022001092

SEAT CUSHION
Sitzkissen
Cojín de asiento

58 x 48 cm
22 3/4" x 19"

95022001

56022001000

RRP/UVF/PVPR

DINING TABLE
Esstisch
Mesa comedor

100 x 100 cm
25 kg
39 1/4" x 39 1/4"
56 lbs

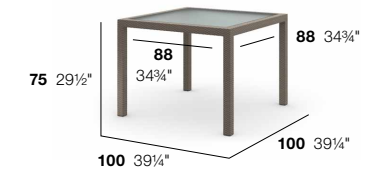
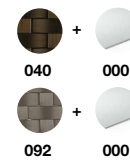

222270

222270092

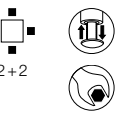

5602706000

DINING TABLE
Esstisch
Mesa comedor

100 x 200 cm
44 kg
39 1/4" x 78 3/4"
98 lbs

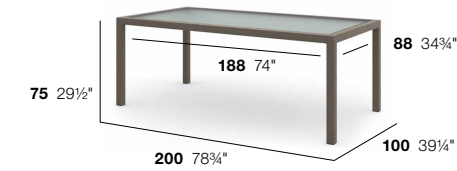
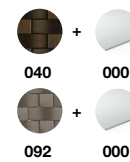

222120

222120092

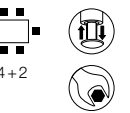

56027066000

BAR TABLE
Bartisch
Mesa alta

80 x 80 cm
15,3 kg
31 1/2" x 31 1/2"
34 lbs

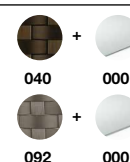

222450

222450092

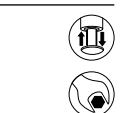

56039061000

BARSTOOL
Barhocker
Taburete de bar

6 kg
13 lbs



SEAT CUSHION
Sitzkissen
Cojín de asiento

41 x 40 cm
16 1/4" x 15 3/4"

95022028

56022028000

022029

022029092

LOUNGE CHAIR
Sessel
Sillón bajo

8 kg
18 lbs



SEAT CUSHION + BACK CUSHION
Sitzkissen + Rückenkissen
Cojín de asiento + Cojín de respaldo

67 x 58 cm + 50 x 60 cm
26 1/2" x 22 3/4" + 19 3/4" x 23 1/2"

95022005

56022005000

022005

022005092

SIDE TABLE
Beistelltisch
Mesa auxiliar

46 x 46 cm
7 kg
18" x 18"
16 lbs

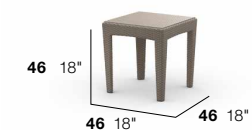
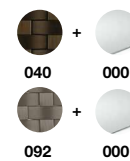

022034

022034092



56022033000

BEACH CHAIR
Sonnenliege
Tumbona

16 kg
36 lbs



CUSHION
Kissen
Cojín

61 x 196 cm
24" x 77 1/4"

95022019

56022019000

022020

022020092



PLAY

Design by Design by PHILIPPE STARCK & EUGENI QUILLET, 2011

Technology meets craft: The world's first chair to combine an injection-molded frame with a hand-woven finish. Simple and iconic.



Side chair, carbon & chalk

Typology

cm inch

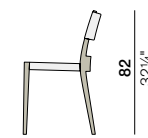

52
20 1/2"
Side chair



52
20 1/2"
Armchair

PLAY

Design by PHILIPPE STARCK & EUGENI QUILLET, 2011



Side chair, carbon & chalk
Side chair, stone & chalk

Materials

Fibers

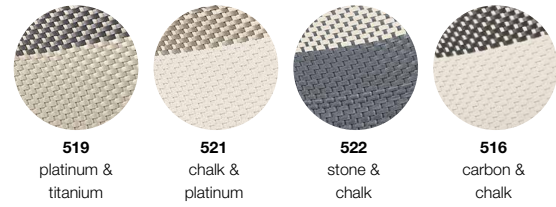

EN MATERIAL
The frames and armrests of the PLAY armchairs and side chairs consist of injection-molded polypropylene, the perfect material for all weather conditions. The seat and back are woven with DEDON Fiber. Clean with a soft cloth and warm water.

DE MATERIAL
Die Rahmen und Armlehnen der PLAY Stühle werden im Spritzgussverfahren aus Polypropylen hergestellt, einem perfekten Material für alle Wetterlagen. Der Sitz und die Rückenlehne sind mit DEDON-Faser beflochten und einfach mit einem weichen Tuch und warmem Wasser zu reinigen.

ES MATERIAL
El armazón y los reposabrazos de las butacas y sillas PLAY están hechos de polipropileno moldeado por inyección, que es el material perfecto para todo tipo de condiciones climatológicas. El asiento y el respaldo están trenzados con fibra DEDON. Limpielas con agua tibia y un paño suave.

RRP/UVF/PVPR

SIDE CHAIR
Esstuhl
Silla de comedor

4,2 kg
10 lbs



402003519



56400003000

402003

ARMCHAIR
Armlehnstuhl
Silla con brazos

4,8 kg
11 lbs



402101519



56400001000

402101

SIDE CHAIR
Esstuhl
Silla de comedor

4,2 kg
10 lbs



403003516



56400003000

403003

ARMCHAIR
Armlehnstuhl
Silla con brazos

4,8 kg
11 lbs

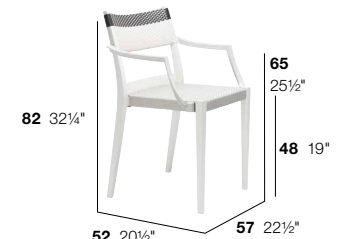

403101516



56400001000

403101



For further information please see [DEDON.de/PLAY](https://www.dedon.de/PLAY)



PORCINI

Design by LORENZA BOZZOLI, 2016

A collection of sculptural side and coffee tables named after the Italian mushrooms it resembles. The perfect complement to any DEDON collection.



Side table marrone Ø 61 Ø 24"
 Side table alba Ø 51 Ø 20"
 Side table bosco Ø 51 Ø 20"
 Side table carrara Ø 41 Ø 16¼"

Typology

cm inch

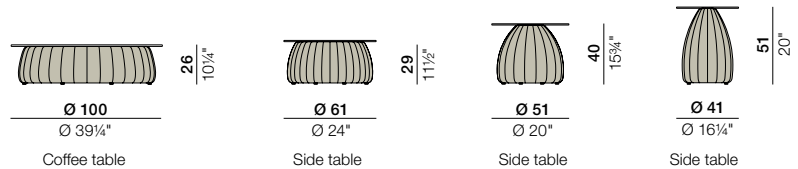

PORCINI

Design by LORENZA BOZZOLI, 2016



Side table alba Ø 51 Ø 20*
Side table bosco Ø 51 Ø 20*

RRP/UVR/PVPR

SIDE TABLE
Beistelltisch
Mesa auxiliar

Ø 61 cm
12,5 kg
Ø 24*
28 lbs

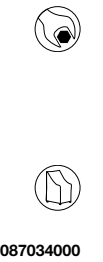
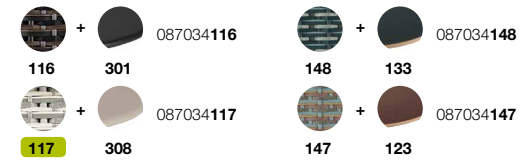

56087034000

SIDE TABLE
Beistelltisch
Mesa auxiliar

Ø 51 cm
9 kg
Ø 20*
20 lbs

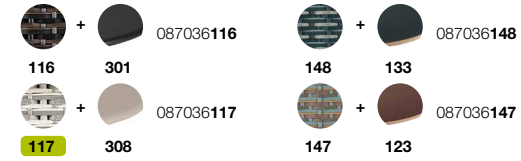

56087036000

SIDE TABLE
Beistelltisch
Mesa auxiliar

Ø 41 cm
8 kg
Ø 16¼*
18 lbs

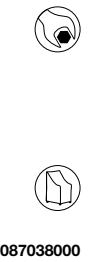
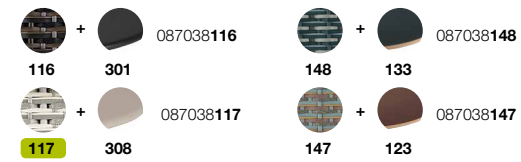

56087038000

COFFEE TABLE
Kaffeetisch
Mesa de centro

Ø 100 cm
26,9 kg
Ø 39¼*
60 lbs

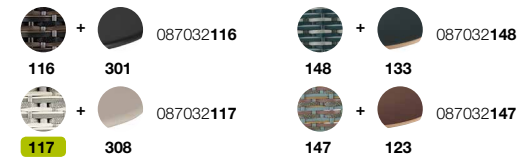

56087032000

EN MATERIAL

The woven base consists of a mix of DEDON Fiber and marine rope, interlaced through a powder coated aluminum structure. The tabletops are made of Monolite Ipergres®, a frost-proof ceramic material that is non-absorbing and highly resistant to indirect tensile stress, impacts, scratches and abrasion. Clean with a damp cloth and warm water.

DE MATERIAL

Die Untergestelle bestehen aus einem Mix aus DEDON-Faser und Seilen, eingeflochten in ein pulverbeschichtetes Alugeflecht. Die Tischplatten aus Keramik werden aus Monolite Ipergres® gefertigt, einem frostsicheren, wasserabweisenden Keramikmaterial mit ausgezeichneter Kratz- und Abriebfestigkeit. Einfach mit einem weichen Tuch und warmem Wasser zu reinigen.

ES MATERIAL

La base está trenzada con una combinación de fibra DEDON y cuerda marina, entrelazadas en una estructura de aluminio con con revestimiento de pintura en polvo. El tablero Monolite Ipergres® es un material cerámico resistente a las heladas y repelente al agua, con una excelente resistencia al peso, los golpes, los arañazos y la abrasión. Limpiar con un paño suave y agua tibia.

Materials

Fiber



Tabletop ceramic

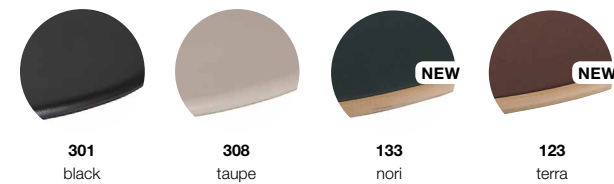

For further information please see [DEDON.de/PORCINI](https://www.dedon.de/PORCINI)

RILLY

Design by GAMFRATESI, 2020



3-seater, taupe melange
2-seater, taupe melange
Cushion: TWIST sand
IZON coffee table 19¼ x 35½", black
pepper/lava

Materials

Combinations

<p>Rope Powder coating Recommended fabrics</p> <p>155 taupe melange 317 black pepper 452 COOL taupe Cat. A 661 TWIST sand Cat. B 675 Kvadrat patio220 Cat. B</p>	<p>Rope Powder coating Recommended fabrics</p> <p>156 teal melange 317 black pepper 458 COOL ash Cat. A 684 MAR nori Cat. B 681 Kvadrat patio970 Cat. B</p>
<p>Fiber Powder coating Recommended fabrics</p> <p>157 taupe touch 317 black pepper 452 COOL taupe Cat. A 660 TWIST beige Cat. B 675 Kvadrat patio220 Cat. B</p>	<p>Fiber Powder coating Recommended fabrics</p> <p>158 teal touch 317 black pepper 458 COOL ash Cat. A 684 MAR nori Cat. B 681 Kvadrat patio970 Cat. B</p>
<p>Fiber Powder coating Recommended fabrics</p> <p>159 rosewood touch 317 black pepper 458 COOL ash Cat. A 660 TWIST beige Cat. B 680 Kvadrat patio370 Cat. B</p>	<p>Fiber Powder coating Recommended fabrics</p> <p>160 saffron touch 317 black pepper 458 COOL ash Cat. A 682 MAR beech Cat. B 681 Kvadrat patio970 Cat. B</p>

Fiber for cocoon chair and footstool only

RRP/UVF/PVPR

ARMCHAIR
Armlehnstuhl
Silla con brazos

5,9 kg
13 lbs



DRY+ SEAT CUSHION
Dry+ Sitzkissen
Dry+ Cojín de asiento

OPTIONAL BACK CUSHION
Optionales Rückenkissen
Cojín de respaldo opcional

46 x 40 cm
18" x 15¾"



103001

103001156

95103201

95103002

56103001000

2-SEATER
2er-Sofa
Sofá 2 plazas

15,7 kg
35 lbs



DRY+ CUSHION SET
Dry+ Kissenset
Dry+ Set de cojines



103012

103012156

95103212

56103012000

3-SEATER
3er-Sofa
Sofá 3 plazas

21,4 kg
46 lbs

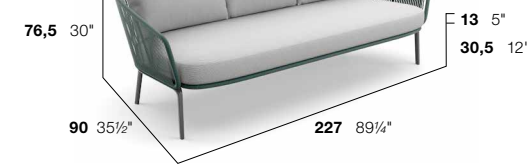
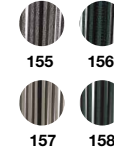

DRY+ CUSHION SET
Dry+ Kissenset
Dry+ Set de cojines



103015

103015156

95103215

56103015000

LOUNGE CHAIR
Sessel
Sillón bajo

9,3 kg
21 lbs



DRY+ CUSHION SET
Dry+ Kissenset
Dry+ Set de cojines



103005

103005156

95103205

56103005000

COCOON CHAIR
Cocoon Sessel
Sillón bajo Cocoon

17,5 kg
39 lbs

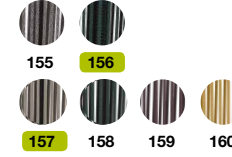

DRY+ CUSHION SET INCLUDING
BACK CUSHION WITH HEADREST
Dry+ Kissenset inkl. Rückenkissen mit Kopfstütze
Dry+ Set de cojines incluyendo cojín de respaldo y con reposacabezas



103008

103008156

95103208

56103008000

FOOTSTOOL
Hocker
Taburete

4,7 kg
10 lbs

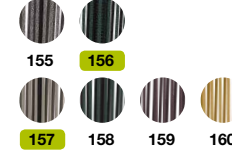

DRY+ SEAT CUSHION
Dry+ Sitzkissen
Dry+ Cojín de asiento



103032

103032156

95103232

56103032000

Complementary tables



MBRACE dining table teak
085055205
See page 91



WA dining table
607073317
black pepper / glass black pepper
See page 173



TIBBO dining table teak
089055205
See page 165

RRP/UV/PVPR

DAYBED LEFT
Daybed links
Daybed izquierdo

13,9 kg
31 lbs



103020156

DRY+ CUSHION SET
Dry+ Kissenset
Dry+ Set de cojines



103020

DAYBED RIGHT
Daybed rechts
Daybed derecho

13,9 kg
31 lbs



103022156

DRY+ CUSHION SET
Dry+ Kissenset
Dry+ Set de cojines



103022

RECOMMENDED DECO CUSHIONS
Empfohlene Dekokissen
Cojines decoración recomendados

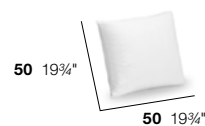

50 19 1/4"

95050082

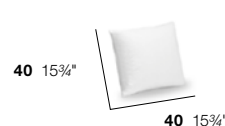

40 15 3/4"

40 15 3/4"

95050081

ADDITIONAL WHEELS FOR DAYBED LEFT AND DAYBED RIGHT
Zusätzliche Rollen für Daybed links und Daybed rechts
Ruedas adicionales para daybeds izquierdos y daybeds derechos



2 PIECES PER PACKAGE
2 Stück pro Paket
2 piezas por paquete



103079000

EN MATERIAL
RILLY comes in a choice of DEDON Fiber or maritime rope. DEDON Fiber taupe touch, teal touch, saffron touch and rosewood touch is characterized by its extraordinary soft touch, matte look, great strength, UV-resistance and ability to withstand even the harshest weather conditions. The rope, which is made of polypropylene, which has a textile touch and excellent tensile strength, is also weatherproof, UV-resistant and light-fast.

DRY+ CUSHIONS
Dry+ cushions are protected by a highly water-repellent interlayer up to 10,000 mm. The fabric is treated to be stain- and water-repellent.

DE MATERIAL
RILLY ist in zwei Ausführungen erhältlich: Aus DEDON-Faser oder einem maritimen Seilmaterial. Die DEDON-Faser in den Farben Taupe Touch, Teal Touch, Saffron Touch und Rosewood Touch besticht durch ihre ungewöhnlich weiche Haptik, den matten Look, ihre Robustheit und UV-Beständigkeit sowie ihre Fähigkeit, selbst den härtesten Bedingungen zu trotzen. Das Polypropylen-Seil mit textilem Touch ist hochreißfest und ebenfalls wetterbeständig, UV-beständig und lichtecht.

DRY+ KISSEN
Die Dry+ Kissen sind durch eine stark wasserabweisende innere Hülle mit einer Wassersäule von 10.000 mm geschützt. Der Stoff ist so behandelt, dass er schmutz- und wasserabweisend ist.

ES MATERIAL
RILLY está disponible en diferentes fi bras DEDON o cuerda náutica. Las fi bras DEDON en los colores taupe touch, teal touch, saffron touch y rosewood touch se caracterizan por su extraordinario tacto suave, aspecto mate, increíble durabilidad, resistencia a los rayos UVA y capacidad de soportar incluso las condiciones climáticas más adversas. La cuerda, elaborada con polipropileno, tiene un tacto parecido al de un tejido y una excelente fuerza de tensión. También es impermeable y resistente a los rayos UVA y a la luz.

DRY+ COJINES
Los cojines Dry+ estan protegidos con un revestimiento muy impermeable con una resistencia al agua de nada menos que 10.000 mm. La tela está tratada para ser resistente a las manchas y al agua.



Cocoon chair rosewood touch
Footstool rosewood touch
Cushion: Kvadrat patio370



For further information please see [DEDON.de/RILLY](https://www.dedon.de/RILLY)



SATELLITE

Design by JEAN-MARIE MASSAUD, 2009

Elegantly simple, streamlined and modern.



Side table Ø 40 cm
Dining table Ø 70 cm

cm inch

Typology

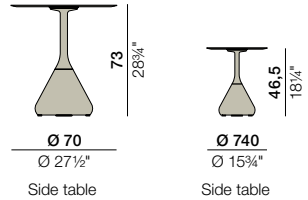

For further information please see
DEDON.de/SATELLITE



Materials

Powder coatings

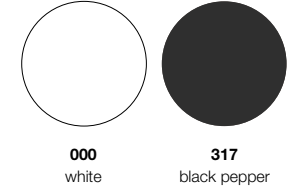

Tabletops HPL

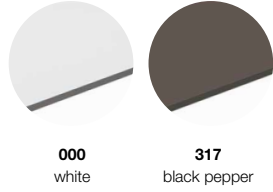

RRP/UV/PVPR

DINING TABLE
Estisch
Mesa comedor



Ø 70 Ø 27 1/2"

050140

050140317

56050040000

SIDE TABLE
Beistelltisch
Mesa auxiliar

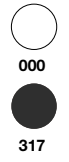

Ø 40 Ø 15 3/4"

050133

050133317

56050033000

EN MATERIAL
Tabletop: "High Pressure Laminate" (HPL) – A non-toxic material that is highly resistant to impact, mechanical stress, moisture and steam. To clean a HPL tabletop, use a soft cloth, warm water and a gentle cleanser if needed. Base: powder coated aluminum.

DE MATERIAL
Tischplatte: „High Pressure Laminate“ (HPL) ist ein ungiftiges Material, das sich durch hohe Stoßfestigkeit und extreme Widerstandskraft gegen mechanische Einwirkungen, Feuchtigkeit und Dampf auszeichnet. Zur Reinigung der Tischplatte eignen sich ein weiches Tuch, warmes Wasser und bei Bedarf ein sanftes Reinigungsmittel. Fuß: Hergestellt aus pulverbeschichtetem Aluminium.

ES MATERIAL
Tablero de mesa: HPL – El laminado de alta presión es un material no tóxico altamente resistente al impacto, estrés mecánico, humedad y vapor. Para limpiar los tableros de las mesas, utilice un paño suave y agua caliente y, si es necesario, un limpiador suave. Base: Fabricado en aluminio con revestimiento de pintura en polvo.

SEALINE

Design by JEAN-MARIE MASSAUD, 2020

A luxurious lounge collection with an easy-chic spirit. Suitable for any season or latitude. Featuring a handcrafted teak structure and a weave of maritime rope or DEDON EcoCycle Fiber.



Right module XL silver beige
 Extended daybed left silver beige
 Cushion: GLAN drift
 Coffee table 174 x 69 cm 68½" x 27¼"
 Bench

Typology

cm inch

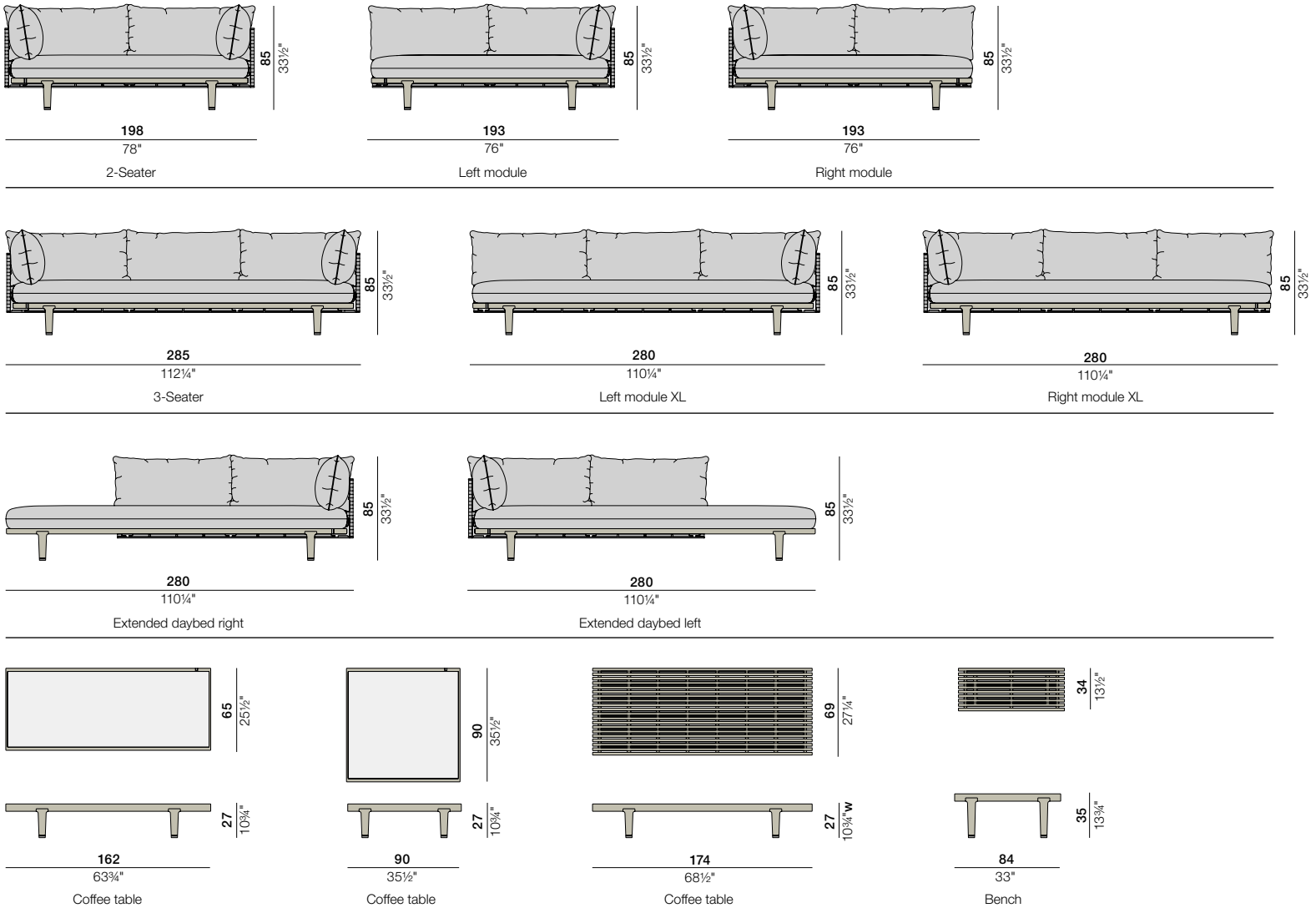

SEALINE

Design by JEAN-MARIE MASSAUD, 2020



2-seater, titan
Cushion: COOL ash
2 additional back cushions
Coffee table 69 x 174 cm

Materials

Rope

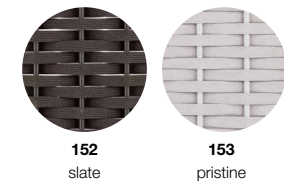

DEDON EcoCycle Fiber



Combinations

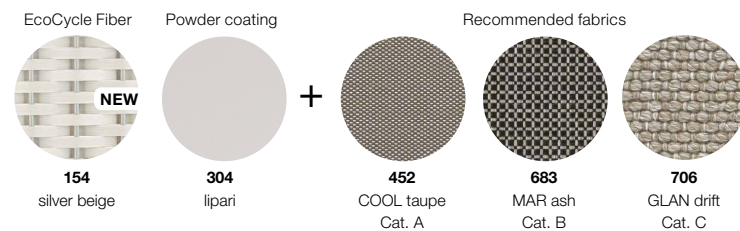
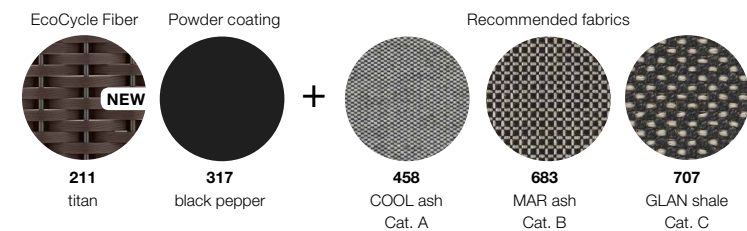
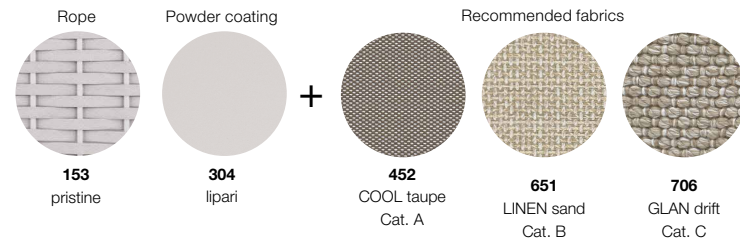
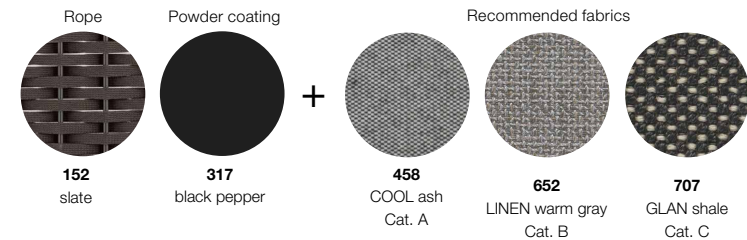

RRP/UV/PVPR

2-SEATER
2er-Sofa
Sofá 2 plazas

Rope: 44,4 kg
Rope: 98 lbs

Fiber: 39,5 kg
Fiber: 88 lbs



105012

105012152

95105212

2x 95105297

56105012000

LEFT MODULE
Modul links
Módulo izquierdo

Rope: 40,2 kg
Rope: 89 lbs

Fiber: 36 kg
Fiber: 80 lbs



105005

105005152

95105203

2x 95105297

56105005000

RIGHT MODULE
Modul rechts
Módulo derecho

Rope: 40,2 kg
Rope: 89 lbs

Fiber: 36 kg
Fiber: 80 lbs



105003

105003152

95105203

2x 95105297

56105003000

3-SEATER
3er-Sofa
Sofá 3 plazas

Rope: 55,6 kg
Rope: 123 lbs

Fiber: 49 kg
Fiber: 108 lbs



105015

105015152

95105215

2x 95105297

56105015000

LEFT MODULE XL
Modul links XL
Módulo izquierdo XL

Rope: 50 kg
Rope: 110 lbs

Fiber: 45 kg
Fiber: 99 lbs



105006

105006152

95105204

2x 95105297

56105006000

RIGHT MODULE XL
Modul rechts XL
Módulo derecho XL

Rope: 50 kg
Rope: 110 lbs

Fiber: 45 kg
Fiber: 99 lbs



105004

105004152

95105204

2x 95105297

56105004000

RECOMMENDED DECO CUSHIONS
Empfohlene Dekokissen
Cojines decoración recomendados

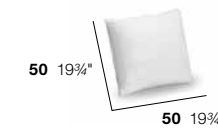

95050082

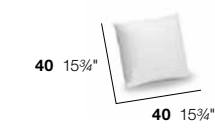

95050081

RRP/UVF/PVPR

EXTENDED DAYBED LEFT
Verlängertes Daybed links
Daybed izquierdo alargado

Rope: 45,2 kg
Rope: 100 lbs

Fiber: 41 kg
Fiber: 90 lbs

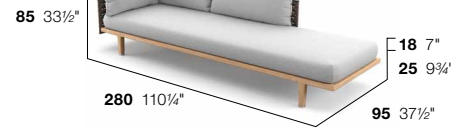

DRY+ CUSHION SET
Dry+ Kissen-set
Dry+ Set de cojines

DRY+ ADDITIONAL BACK CUSHION
Dry+ Zusätzliches Rücken-kissen
Dry+ Cojín de respaldo adicional

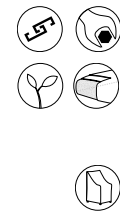

85 x 51 x 15 cm
33 1/2" x 20" x 6"

105017 105017152 95105217 2x 95105297 56105017000

EXTENDED DAYBED RIGHT
Verlängertes Daybed rechts
Daybed derecho alargado

Rope: 45,2 kg
Rope: 100 lbs

Fiber: 41 kg
Fiber: 90 lbs



DRY+ CUSHION SET
Dry+ Kissen-set
Dry+ Set de cojines

DRY+ ADDITIONAL BACK CUSHION
Dry+ zusätzliches Rücken-kissen
Dry+ Cojín de respaldo adicional

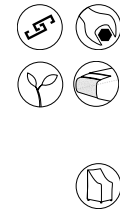

85 x 51 x 15 cm
33 1/2" x 20" x 6"

105018 105018152 95105217 2x 95105297 56105018000

COFFEE TABLE
Kaffeetisch
Mesa de centro

69 x 174 cm
27 1/4" x 68 1/2"
32,5 kg
72 lbs

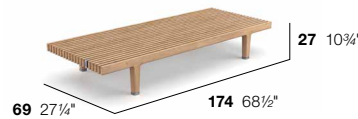

105035205



56105035000

COFFEE TABLE
Kaffeetisch
Mesa de centro

162 x 65 cm
36,5 kg
63 3/4" x 25 1/2"
80 lbs

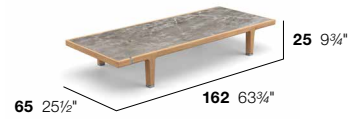

105037 Set: 105037319 56105037000

COFFEE TABLE
Kaffeetisch
Mesa de centro

90 x 90 cm
24 kg
35 1/2" x 35 1/2"
53 lbs

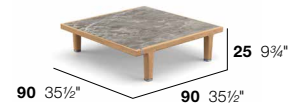

105033 Set: 105033319 56105033000

BENCH
Bank
Banco

10 kg
22 lbs



105011205

56105011000

Tabletop mineral-composite

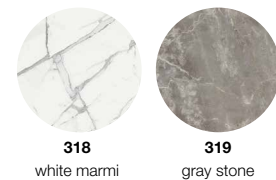

SEALINE

OPTIONAL COMBINATIONS

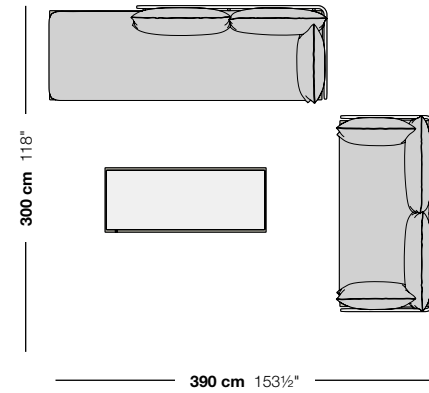

SEALINE Setting 01

- 1x 105018 – Extended daybed right, Dry+ cushion set
- 1x 105012 – 2-Seater, Dry+ cushion set
- 4x 95105297 – Dry+ additional back cushion
- 1x 105037 – Coffee table 65 x 162 cm 25 1/2" x 63 3/4"

Recommended deco cushions:
2x 95050081 – 40 x 40 cm 15 3/4" x 15 3/4"
1x 95050082 – 50 x 50 cm 19 3/4" x 19 3/4"

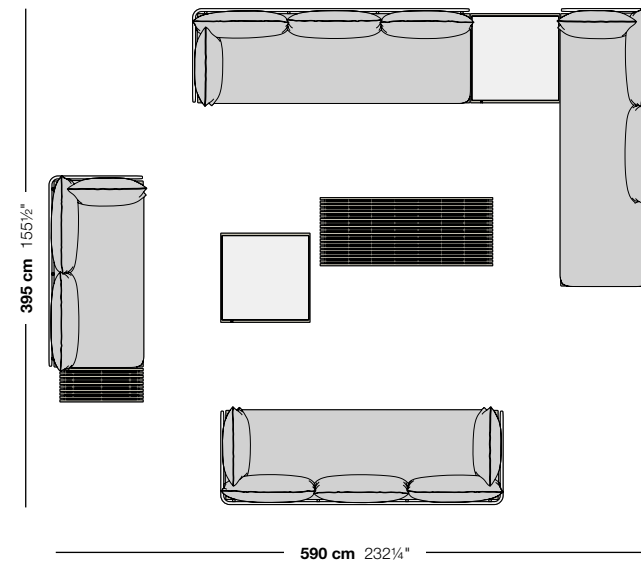

SEALINE Setting 02

- 1x 105004 – Right module XL, Dry+ cushion set
- 1x 105005 – Left module, Dry+ cushion set
- 1x 105015 – 3-Seater, Dry+ cushion set
- 1x 105017 – Extended daybed left, Dry+ cushion set
- 10x 95105297 – Dry+ additional back cushion
- 1x 105035205 – Coffee table 69 x 174 cm 27 1/4" x 68 1/2"
- 2x 105033 – Coffee table 90 x 90 cm 35 1/2" x 35 1/2"
- 1x 105011205 – Bench

Recommended deco cushions:
4x 95050081 – 40 x 40 cm 15 3/4" x 15 3/4"
3x 95050082 – 50 x 50 cm 19 3/4" x 19 3/4"

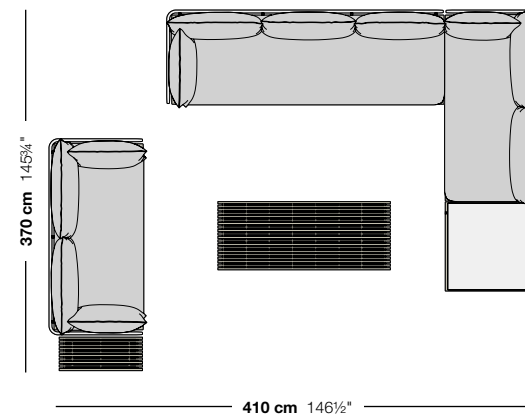

SEALINE Setting 03

- 1x 105003 – Right module, Dry+ cushion set
- 1x 105004 – Right module XL, Dry+ cushion set
- 1x 105012 – 2-Seater, Dry+ cushion set
- 8x 95105297 – Dry+ additional back cushion
- 1x 105035205 – Coffee table 69 x 174 cm 27 1/4" x 68 1/2"
- 1x 105033 – Coffee table 90 x 90 cm 35 1/2" x 35 1/2"
- 1x 105011205 – Bench

Recommended deco cushions:
5x 95050081 – 40 x 40 cm 15 3/4" x 15 3/4"
4x 95050082 – 50 x 50 cm 19 3/4" x 19 3/4"

EN MATERIAL

SEALINE comes in a choice of DEDON Fiber or maritime rope. From 2021 onwards, SEALINE in titan and silver beige comes with DEDON EcoCycle Fiber, which is produced with polyethylene from renewable agricultural resources (sugarcane-derived ethanol). The rope, which is made of polypropylene, has a textile touch and excellent tensile strength. It is also weatherproof, UV-resistant and non-fading. The solid teak coffee table and bench are made of premium teak. Wash with natural soap dissolved in warm water. The tabletops of coffee tables with teak frames use a mineral composite topped with a printed marble pattern. The tabletop material is scratch-resistant, non-porous and highly resistant to frost, UV-rays and scratching.

DRY+ CUSHIONS

Dry+ cushions are protected by a highly water-repellent interlayer up to 10,000 mm. The fabric is treated to be stain- and water-repellent.

FUNCTION

The backrests of the left and right modules and left and right modules XL can be flipped and used on the opposite sides.

DE MATERIAL

SEALINE ist in zwei Ausführungen erhältlich: Aus DEDON-Faser oder einem maritimen Seilmaterial. Ab 2021 wird SEALINE in titan und silver beige mit der DEDON EcoCycle Faser geliefert, die mit Polyethylen aus nachwachsenden landwirtschaftlichen Rohstoffen (Ethanol aus Zuckerrohr) hergestellt wird. Das Polypropylen-Seil mit textilem Touch ist hochreißfest, wetterbeständig, UV-beständig und lichtecht. Der Couchtisch und die Bank aus Vollholz sind aus Premium-Teakholz gefertigt. Zur Reinigung bitte warmes Wasser verwenden, in dem natürliche Seifenflocken vollständig aufgelöst wurden. Die Tischplatten der Couchtische mit Teakrahmen bestehen aus einem mineralischen Kompositmaterial mit aufgedrucktem Marmormuster auf der Oberseite. Das Material ist kratzfest, porenfrei und hochwiderstandsfähig gegen Frost, UV-Strahlung und Schrammen.

DRY+ KISSEN

Die Dry+ Kissen sind durch eine stark wasserabweisende innere Hülle mit einer Wassersäule von 10.000 mm geschützt. Der Stoff ist so behandelt, dass er schmutz- und wasserabweisend ist.

FUNKTION

Die Rückenlehnen der linken und rechten XL-Module können auf die jeweils andere Seite umgelegt werden.

ES MATERIAL

SEALINE está disponible en diferentes fi bras DEDON o cuerda náutica. A partir de 2021, SEALINE titan y silver beige se abastecerán de la fibra DEDON EcoCycle, que se produce con polietileno a partir de materias primas agrícolas renovables (etanol derivado de la caña de azúcar). La cuerda, elaborada con polipropileno, tiene un tacto parecido al de un tejido y una excelente fuerza de tensión. También es impermeable y resistente a los rayos UVA y a la luz. La mesa de centro y el banco de madera maciza están elaborados con teca de primera calidad. Limpiar con agua tibia una vez disueltas las virutas de jabón natural. Los tableros de las mesas de centro con estructura de teca están hechos a partir de un compuesto mineral que presenta un estampado de diseño amarmolado. El material con el que se fabrican los tableros es resistente a los rasguños, no tiene poros y es altamente resistente a las heladas, los rayos UVA y a las rozaduras.

DRY+ COJINES

Los cojines Dry+ están protegidos con un revestimiento muy impermeable con una resistencia al agua de nada menos que 10.000 mm. La tela está tratada para ser resistente a las manchas y al agua.

FUNCIÓN

Los respaldos de los módulos derechos e izquierdos y de los módulos XL derechos e izquierdos pueden voltearse y usarse por el lado opuesto.



For further information please see [DEDON.de/SEALINE](https://www.dedon.de/SEALINE)



SEASHELL

Design by JEAN-MARIE MASSAUD, 2009



Side chairs taupe light

Typology

cm inch

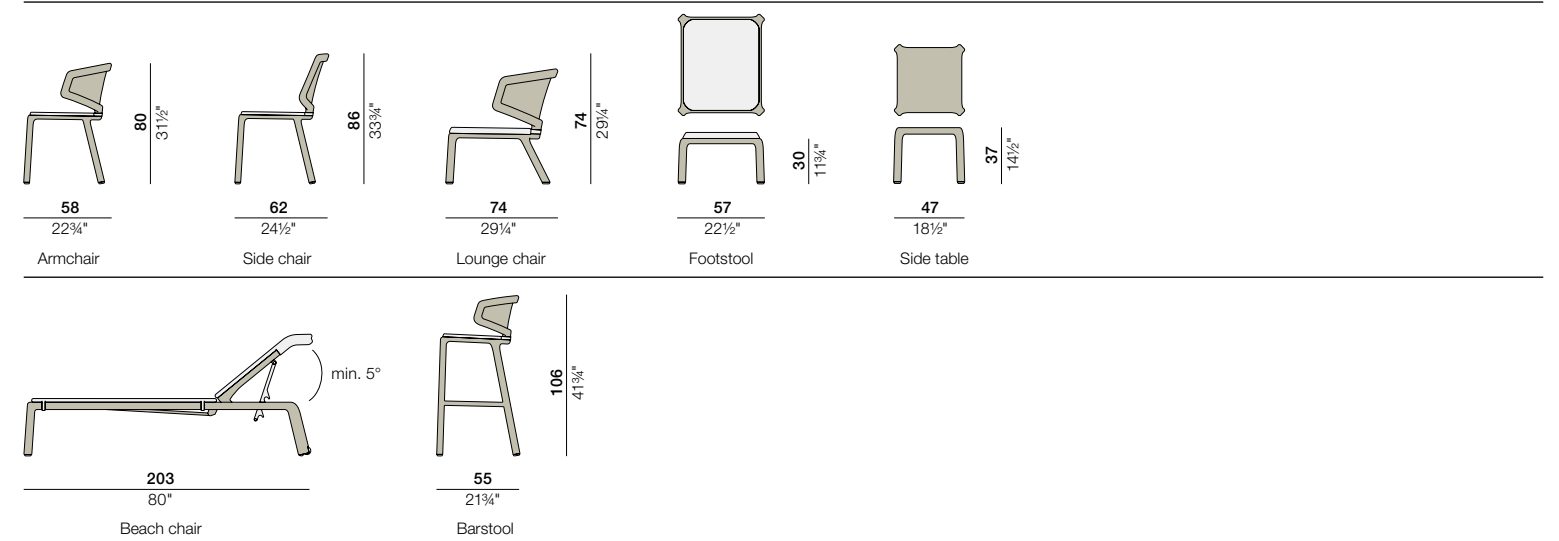

SEASHELL

Design by JEAN-MARIE MASSAUD, 2009



Lounge chair taupe light
Cushion: COOL taupe
Footstool

Materials

Recommended combinations

<p>Fiber</p> <p>040 bronze</p>	<p>Recommended fabrics</p> <p>452 Cat. A COOL taupe</p>	<p>662 Cat. B TWIST gray</p>	+	<p>Fiber</p> <p>083 chalk</p>	<p>Recommended fabrics</p> <p>450 Cat. A COOL white</p>	<p>660 Cat. B TWIST beige</p>	+	<p>Fiber</p> <p>092 taupe light</p>	<p>Recommended fabrics</p> <p>450 Cat. A COOL taupe</p>	<p>661 Cat. B TWIST sand</p>
---	--	---	---	--	--	--	---	--	--	---



For further information please see [DEDON.de/SEASHELL](https://www.dedon.de/SEASHELL)



RRP/UVF/PVPR

ARMCHAIR
Armlehnstuhl
Silla con brazos

4,8 kg
11 lbs



049001

SIDE CHAIR
Esststuhl
Silla de comedor

4,6 kg
10 lbs



049003

LOUNGE CHAIR
Sessel
Sillón bajo

7,4 kg
16 lbs



049005

FOOTSTOOL
Hocker
Taburete

3,8 kg
9 lbs



049031

SIDE TABLE
Beistelltisch
Mesa auxiliar

47 x 47 cm
2,5 kg
18 1/2" x 18 1/2"
6 lbs



049033

BEACH CHAIR
Sonnenliege
Tumbona

16 kg
35 lbs



049020

BARSTOOL
Barhocker
Taburete de bar

6 kg
13 lbs



049028



049001092

SEAT CUSHION
Sitzkissen
Cojín de asiento

40 x 44 cm
15 1/4" x 17 1/4"



95049001

56049001000



049003092

SEAT CUSHION
Sitzkissen
Cojín de asiento

40 x 44 cm
15 1/4" x 17 1/4"



95049001

56049003000



049005092

SEAT CUSHION
Sitzkissen
Cojín de asiento

64 x 52 cm
25 1/4" x 20 1/2"

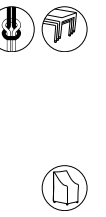

95049005

56049005000

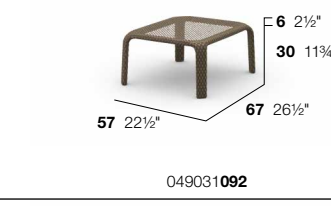

049031092

SEAT CUSHION
Sitzkissen
Cojín de asiento

57 x 47 cm
22 1/2" x 18 1/2"



95049031

56049031000

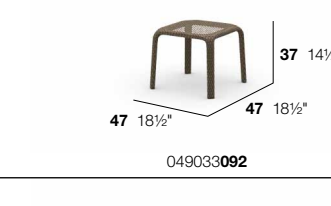

049033092

CUSHION
Kissen
Cojín

76 x 203 cm
30" x 80"

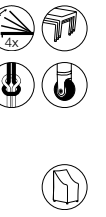

95049020

56049020000

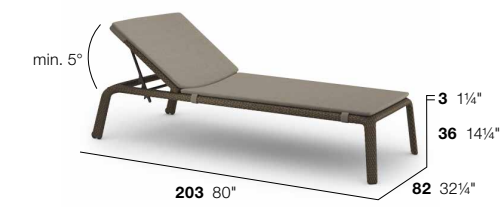

049020092



049028092



56049028000



SEAX

Design by JEAN-MARIE MASSAUD, 2012

An ultra-refined director's chair. Streamlined aluminum frame, precision-engineered for effortless folding. Inspired by America's Cup racing yachts.



Armchairs
 Nori/sail petrol dark
 Black/sail elemental dark
 White/sail petrol light
 White/sail elemental light

Typology

cm inch

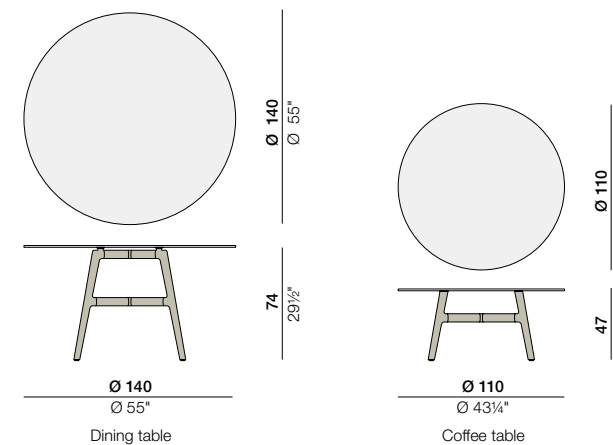
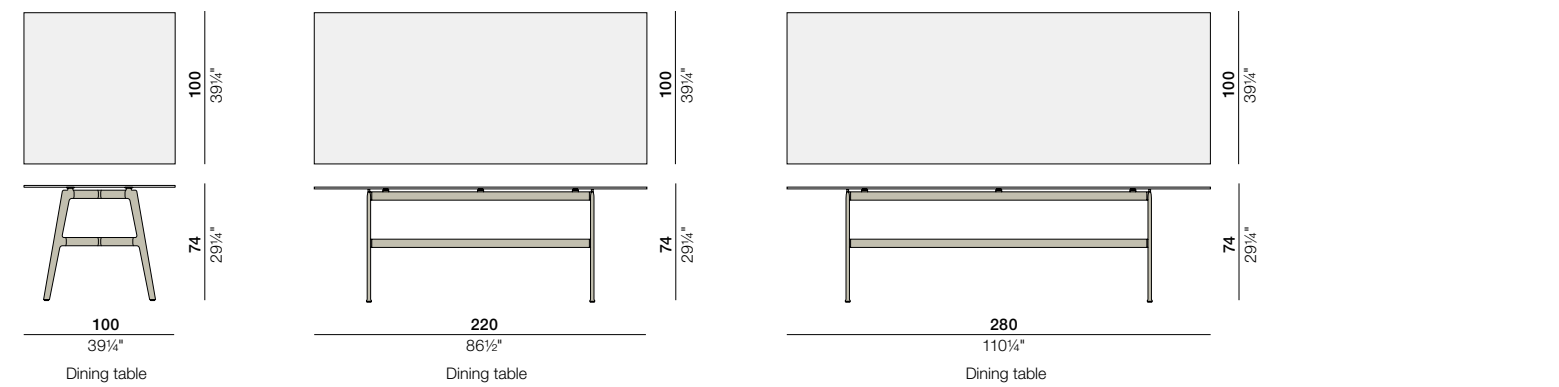
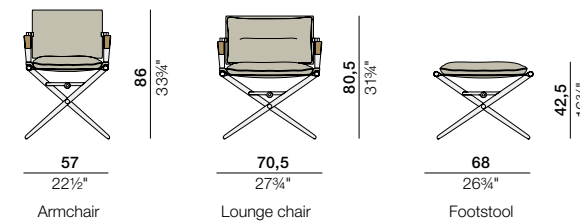

SEAX

Design by JEAN-MARIE MASSAUD, 2012



Armchairs white/sail taupe

Materials

Combinations

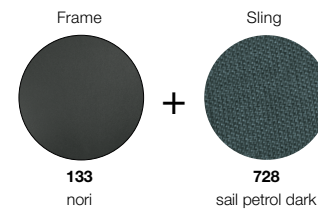
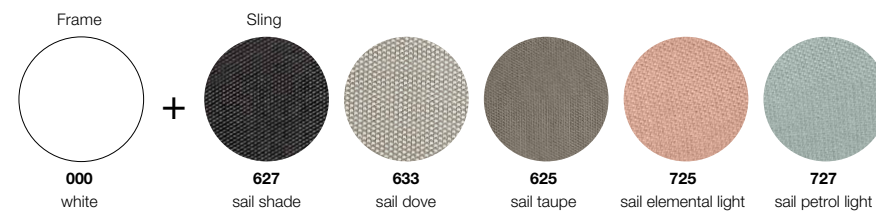
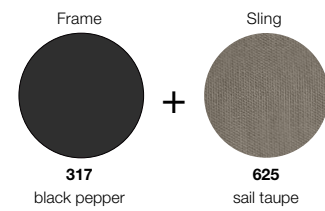

Armrests



Tabletops

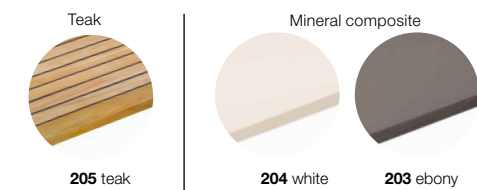

RRP/UVF/PVPR

ARMCHAIR
Armlehnstuhl
Silla con brazos

7 kg
15 lbs



702311627



702301627



701311627



701301627

SEAT CUSHION
Sitzkissen
Cojín de asiento

49 x 50 x 6 cm
19 1/4" x 19 3/4" x 2 1/4"

95700001

56700001000



702311633



702301633



701311633



701301633



702311625



702301625



707311625



707301625



701311625



701301625



701311725



701301725



702311726



702301726



701311727



701301727



709311728



709301728

LOUNGE CHAIR
Sessel
Sillón bajo

8 kg
18 lbs



702315627



702305627



701315627



701305627

SEAT CUSHION + BACK CUSHION
Sitzkissen + Rückenkissen
Cojín de asiento + Cojín de respaldo

63 x 57 x 6 cm + 60 x 37 cm
24 3/4" x 22 1/2" x 2 1/4" + 23 1/2" x 14 1/2"



95700005

56700005000



702315633



702305633



701315633



701305633



702315625



702305625



707315625



707305625



701315625



701305625



701315725



701305725



702315726



702305726



701315727



701305727



709315728



709305728

FOOTSTOOL
Hocker
Taburete

5 kg
11 lbs



702031627



701031627



SEAT CUSHION
Sitzkissen
Cojín de asiento

63 x 57 x 6 cm
24 3/4" x 22 1/2" x 2 1/4"



95700031

56700031000



702031633



701031633



702031625



707031625



701031625



701031725



702031726



701031727



709031728



ALL ITEMS ARE FOLDABLE.
Alle Produkte sind faltbar.
Todas las piezas son plegables.



SEAT CUSHION ARMCHAIR
Sitzkissen Armlehnstuhl
Cojín de asiento Silla con brazos



SEAT CUSHION + BACK CUSHION LOUNGE CHAIR
Sitzkissen + Rückenkissen Sessel
Cojín de asiento + cojín de respaldo sillón bajo



SEAT CUSHION FOOTSTOOL
Sitzkissen Hocker
Cojín de asiento taburete

Recommended cushion combinations

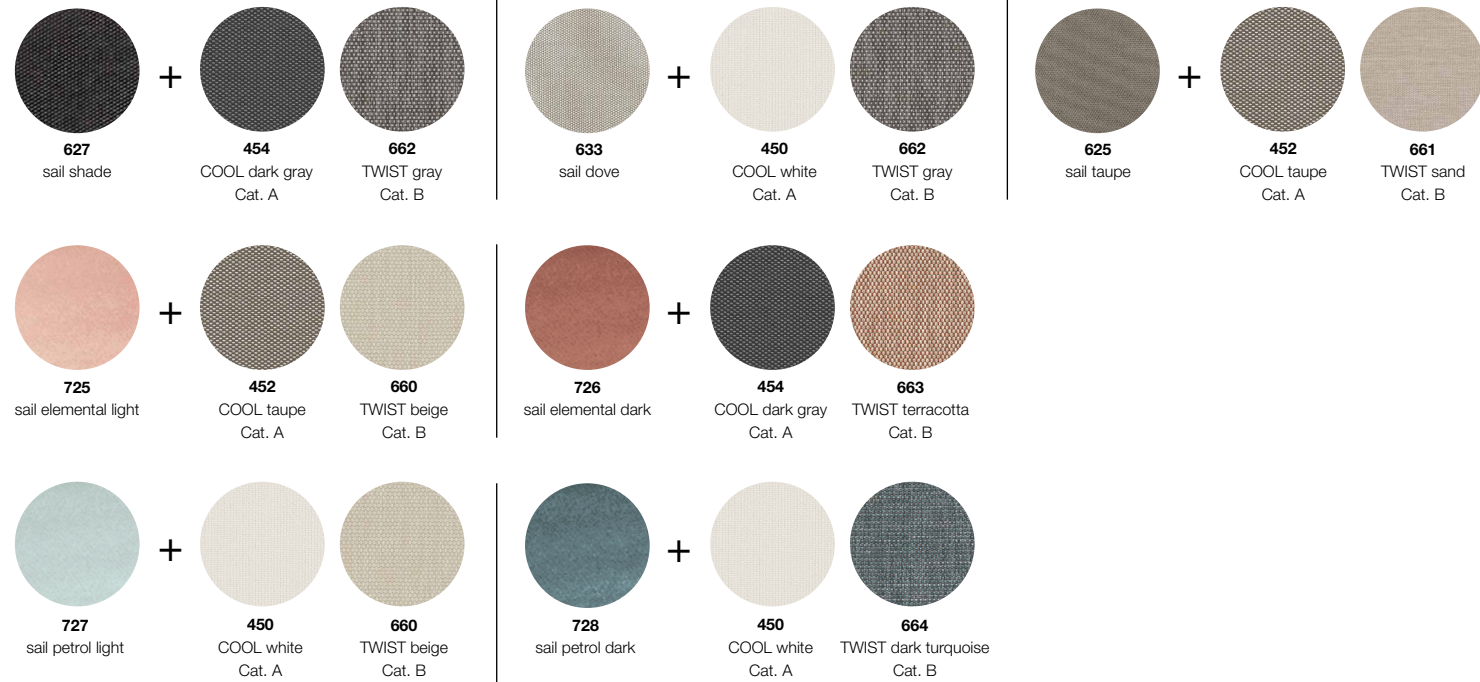

EN MATERIAL
The structure of the SEAX armchair and lounge chair is made of powder coated die-cast aluminum. The seat and back textile is a mix of PVC, acrylic and polyester. The armrest covers are made out of teak-finished plywood.
Clean the frame, seat and backrest with a soft cloth and warm water. Clean the plywood armrest covers with a damp cloth and do not apply cleaning detergents of any kind. To maintain their beautiful wood finish, the SEAX armchairs and lounge chairs with plywood armrests should be protected from moisture and kept indoors when not in use. For a low-maintenance seating alternative, choose the armchair and lounge chair without plywood armrests.

DE MATERIAL
Die Rahmen von SEAX Armlehnstuhl und Sessel bestehen aus pulverbeschichtetem, druckgegossenem Aluminium. Sitzfläche und Rückenlehne bestehen aus einem Stoff, der aus PVC, Acryl und Polyester gefertigt wird. Das Holzdekor der Armlehnen besteht aus mit Teakholz beschichtetem Schichtholz.
Rahmen, Sitz und Lehne mit einem weichen Tuch und warmem Wasser reinigen. Die Schichtholz-Armlehnen reinigen Sie mit einem feuchten Tuch und niemals mit Reinigungsmitteln. Schützen Sie die SEAX Armlehnstühle und Sessel vor Feuchtigkeit und bewahren Sie sie im Innenbereich auf, wenn Sie sie nicht nutzen, damit die schöne Holzoberfläche nicht leidet. Als pflegeleichte Alternative wählen Sie den Armlehnstuhl oder den Sessel mit Armlehnen ohne Holzoberflächen.

ES MATERIAL
El armazón de SEAX esta hecho de aluminio de fundición revestido de pintura en polvo. El asiento y el respaldo constan de un tejido mezcla de PVC, acrílico y poliéster. Las fundas de los reposabrazos son de madera contrachapada con acabados en teca.
Limpie el marco, el asiento y el respaldo con un paño suave y agua tibia. Limpie las fundas de contrachapado de los reposabrazos con un paño húmedo y no aplique detergentes limpiadores de ningún tipo. Para mantener su bonito acabado en madera, las sillas con brazos y sillones bajos SEAX con reposabrazos en madera contrachapada deben estar protegidos contra la humedad y mantenerse en el interior cuando no se usen. Como alternativa para un bajo mantenimiento, escoja la silla con brazos y el sillón bajo sin reposabrazos de madera contrachapada.

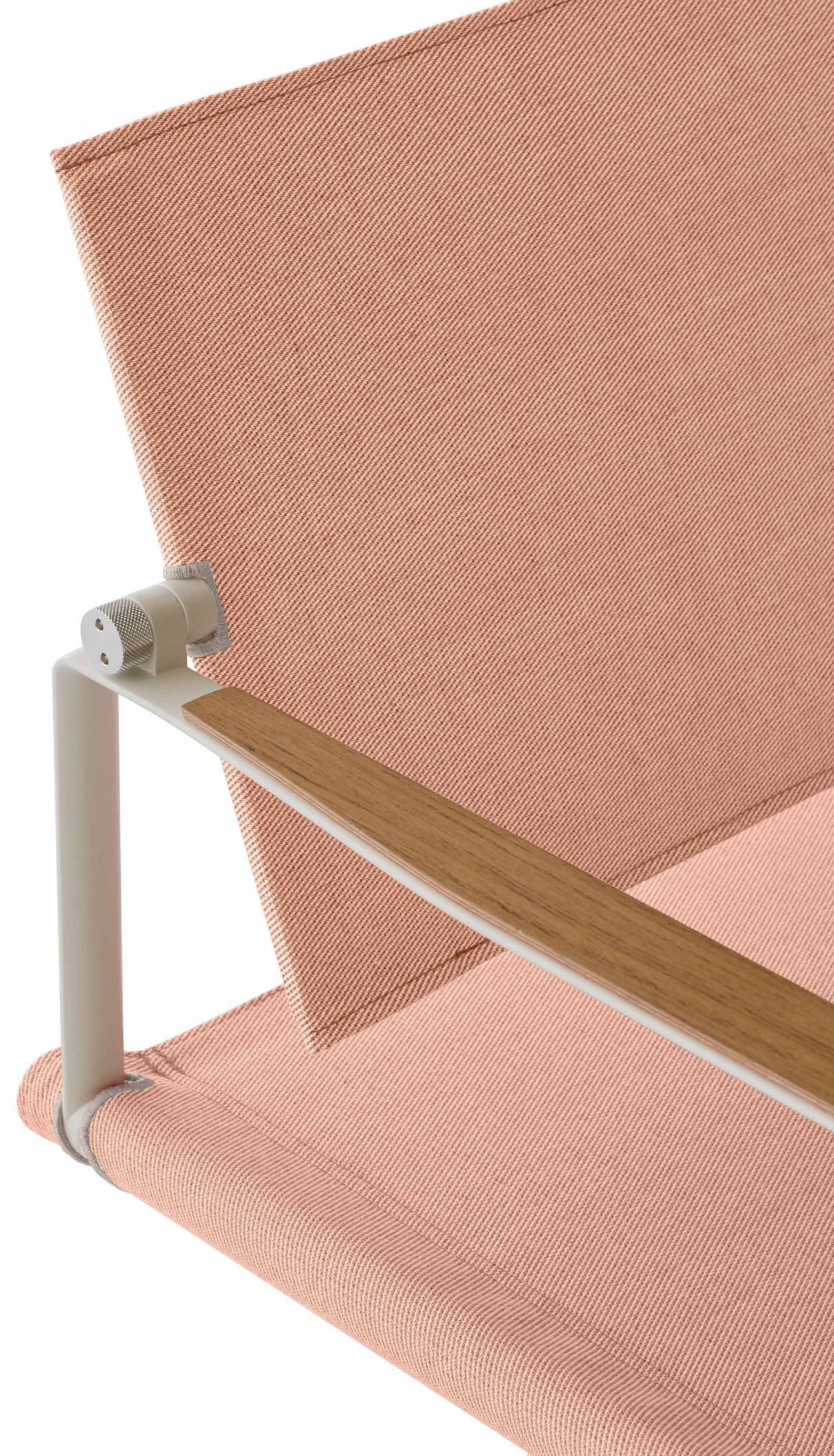

RRP/UVF/PVPR

DINING TABLE
Esstisch
Mesa comedor

100 × 100 cm
39¼" × 39¼"
40,5 kg
90 lbs

- 204 + 000 701076204 **white / white**
- 203 + 329 702076203 **ebony / black**
- 203 + 317 707076203 **ebony / black pepper**

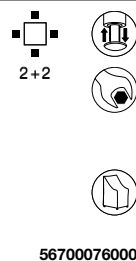

56700076000

- 205 + 000 701076205 **teak / white**
- 205 + 329 702076205 **teak / black**
- 205 + 317 707076205 **teak / black pepper**



30 kg 67 lbs

DINING TABLE
Esstisch
Mesa comedor

100 × 220 cm
39¼" × 86½"
82 kg
181 lbs

- 204 + 000 701040204 **white / white**
- 203 + 329 702040203 **ebony / black**
- 203 + 317 707040203 **ebony / black pepper**

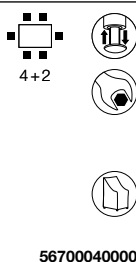
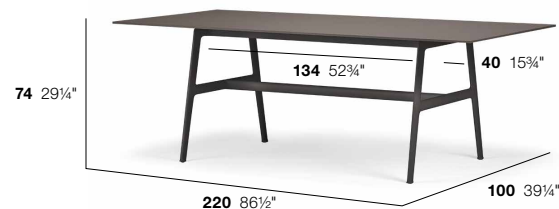

56700040000

- 205 + 000 701040205 **teak / white**
- 205 + 329 702040205 **teak / black**
- 205 + 317 707040205 **teak / black pepper**

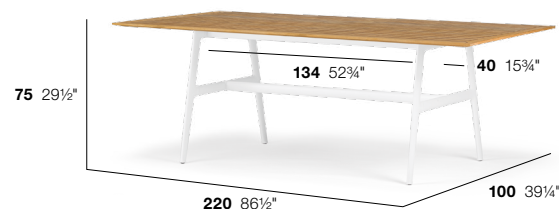

52 kg 115 lbs

EN MATERIAL

The base consists of powder coated aluminum profiles with powder coated, die-cast aluminum legs. Tabletops come in two options: Ebony and white tabletops consist of a self-supporting mineral-composite slab, cut by water jet from the largest premium sintered porcelain slabs available on the market. Teak tabletop consists of premium teak. The sealant used between the teak slats are the same as those widely used on yacht decks and are designed to expand and contract with teak's natural movement.

DE MATERIAL

Das Gestell besteht aus pulverbeschichteten Aluminiumprofilen mit pulverbeschichteten Aludruckgussbeinen. Die Tischplatten sind in zwei Varianten verfügbar: ebony und white. Sie bestehen aus einem freitragenden Mineralverbundmaterial, das per Wasserstrahl aus den größten am Markt erhältlichen gesinterten Porzellanplatten geschnitten wird. Die Teak-Tischplatte besteht aus hochwertigem Teakholz. Dichtungsfugen zwischen den Teakleisten erlauben dem Holz, sich im Rahmen seiner natürlichen Bewegung auszudehnen bzw. zusammenzuziehen.

ES MATERIAL

La base combina perfiles de aluminio recubierto en polvo con patas de aluminio fundido recubierto en polvo. Los tableros están disponibles en dos opciones: ebony y white. Consisten en una placa autoportante de compuesto mineral que ha sido cortada mediante chorro de agua a partir de las placas de excelente porcelana sinterizada, las más grandes del mercado. El tablero de teca está elaborado con teca premium. Las juntas entre las laminas de teca, muy usadas en las cubiertas de los yates, permiten que la madera se expanda y se contraiga respetando su movimiento natural.

RRP/UVF/PVPR

DINING TABLE
Esstisch
Mesa comedor

100 × 280 cm
39¼" × 110¼"
99 kg
219 lbs

- 204 + 000 701067204 **white / white**
- 203 + 329 702067203 **ebony / black**
- 203 + 317 707067203 **ebony / black pepper**

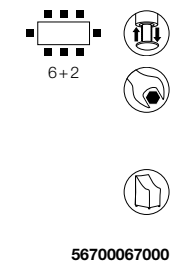
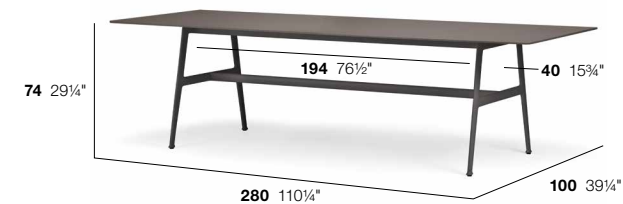

56700067000

- 205 + 000 701067205 **teak / white**
- 205 + 329 702067205 **teak / black**
- 205 + 317 707067205 **teak / black pepper**



63 kg 139 lbs

DINING TABLE
Esstisch
Mesa comedor

Ø 140 cm
Ø 55"
56,5 kg
125 lbs

- 204 + 000 701046204 **white / white**
- 203 + 329 702046203 **ebony / black**
- 203 + 317 707046203 **ebony / black pepper**



56700046000

- 205 + 000 701046205 **teak / white**
- 205 + 329 702046205 **teak / black**
- 205 + 317 707046205 **teak / black pepper**



39 kg 86 lbs

COFFEE TABLE
Kaffeetisch
Mesa de centro

Ø 110 cm
Ø 43¼"
40 kg
89 lbs

- 204 + 000 701036204 **white / white**
- 203 + 329 702036203 **ebony / black**
- 203 + 317 707036203 **ebony / black pepper**



56700036000

- 205 + 000 701036205 **teak / white**
- 205 + 329 702036205 **teak / black**
- 205 + 317 707036205 **teak / black pepper**



23 kg 51 lbs



For further information please see DEDON.de/SEAX



SWINGREST

Design by DANIEL POUZET, 2013

The ultimate hanging lounge collection. Features a basket-like bottom woven of DEDON Fiber. All items also available in standing versions.



Hanging lounge incl. canopy
Cushion: COOL white

Typology

cm inch

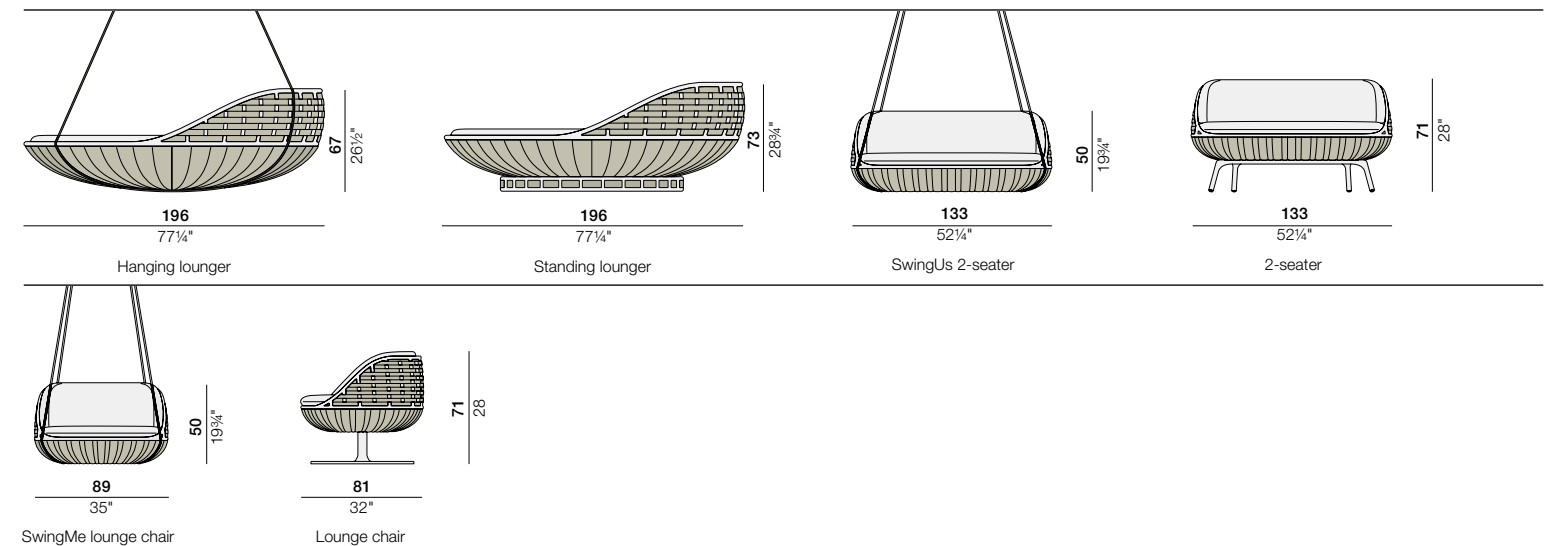

SWINGREST

Design by DANIEL POUZET, 2013



Swinging lounger, incl. base chalk
Cushion: COOL white

RRP/UVF/PVPR

HANGING LOUNGER*
Hanging lounger
Hanging lounger

45 kg
99 lbs

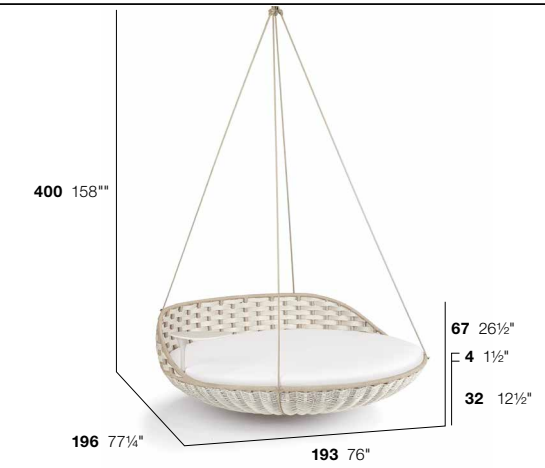
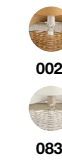

SEAT CUSHION
Sitzkissen
Cojín de asiento

Ø 192 x 16 cm
Ø 75 1/2" x 6 1/4"



091021

CANOPY FOR HANGING LOUNGER
Himmel für Hanging lounger
Velo para Hanging lounger

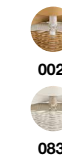

091021083

95090119

0009120002



00091100000

STANDING LOUNGER, INCL. BASE*
Standing lounger, inkl. Untersatz
Standing lounger, base incl.

52,2 kg
115 lbs

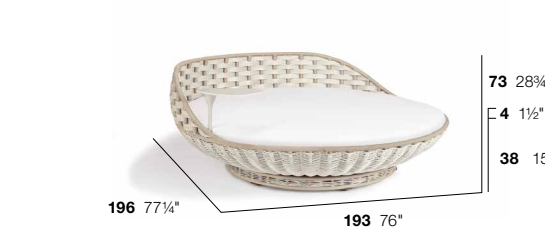
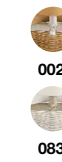

SEAT CUSHION
Sitzkissen
Cojín de asiento

Ø 192 x 16 cm
Ø 75 1/2" x 6 1/4"



091023

BASE, ROTATING – SUITABLE FOR HANGING AND STANDING LOUNGER
Untersatz, drehbar – passend für Hanging und Standing lounger
Base rotatoria – adaptable para el hanging y standing lounger

7,2 kg
16 lbs



95090119

091018083



091018

RECOMMENDED NUMBER OF DECO CUSHIONS
Empfohlene Dekokissenmenge
Número de cojines decoración recomendados



6x 95050087

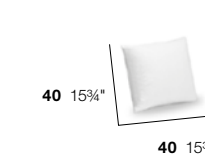

4x 95050081

Materials

Combinations



For further information please see DEDON.de/SWINGREST

* EN ATTENTION
Weight capacity 350 kg/772 lbs

DE ACHTUNG
Tragkraft 350 kg/772 lbs

ES ATENCIÓN
Capacidad de carga 350 kg/772 lbs

RRP/UVR/PVPR

SWINGME LOUNGE CHAIR*
SwingMe Sessel
SwingMe Columpio individual

11 kg
24 lbs

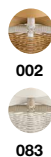

SEAT CUSHION
Sitzkissen
Cojín de asiento
85 x 78 cm
33 1/2" x 30 3/4"

BACK CUSHION
Rückenkissen
Cojín de respaldo
152 x 29 cm
59 3/4" x 11 1/2"



091017

091017083

95091005

95091006

56091005000

LOUNGE CHAIR**
Sessel
Sillón bajo

23 kg
51 lbs

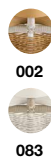

SEAT CUSHION
Sitzkissen
Cojín de asiento
85 x 78 cm
33 1/2" x 30 3/4"

BACK CUSHION
Rückenkissen
Cojín de respaldo
152 x 29 cm
59 3/4" x 11 1/2"



091007

091007083

95091005

95091006

56091005000

RECOMMENDED NUMBER OF DECO CUSHIONS
Empfohlene Dekokissenmenge
Número de cojines decoración recomendados

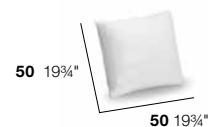

1x 95050082

2x 95050081

SWINGUS 2-SEATER***
SwingUs 2er-Sofa
SwingUs Columpio 2 plazas

15 kg
33 lbs



SEAT CUSHION
Sitzkissen
Cojín de asiento
124 x 78 cm
48 3/4" x 30 3/4"

BACK CUSHION
Rückenkissen
Cojín de respaldo
204 x 29 cm
80 1/4" x 11 1/2"



091015

091015083

95091012

95091013

56091012000

TETHERING ROPE FOR HANGING LOUNGER
Bodenbefestigung für Hanging Lounger
Opciones de sujecion para hanging lounger

1,4 kg
3,5 lbs

23091005002

TETHERING ROPE FOR SWINGME LOUNGE CHAIR
Bodenbefestigung für SwingMe Sessel
Opciones de sujecion para SwingMe columpio individual

1,4 kg
3,5 lbs

23091005004

TETHERING ROPE FOR SWINGUS 2-SEATER
Bodenbefestigung für SwingUs 2er-Sofa
Opciones de sujecion para SwingUs columpio 2 plazas

1,4 kg
3,5 lbs

23091005007



RRP/UVR/PVPR

CANOPY FOR SWINGUS 2-SEATER
Himmel für SwingUs 2er-Sofa
Velo para SwingUs Columpio 2 plazas

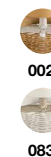

230 91"

00091015000

2-SEATER
2er-Sofa
Sofá 2 plazas

15 kg
33 lbs

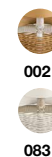

SEAT CUSHION
Sitzkissen
Cojín de asiento
124 x 78 cm
48 3/4" x 30 3/4"

BACK CUSHION
Rückenkissen
Cojín de respaldo
204 x 29 cm
80 1/4" x 11 1/2"



091014

091014083

95091012

95091013

56091012000

RECOMMENDED NUMBER OF DECO CUSHIONS
Empfohlene Dekokissenmenge
Número de cojines decoración recomendados



3x 95050082

2x 95050081



EN CANOPY

The SWINGREST canopy is made of 100% solution-dyed outdoor acrylic fabric with a color fastness of 7/8. It has a mold-resistant, soil-resistant and water-resistant finishing made with Teflon®. The aluminum ring is wrapped with rope.

HANGINGS

Rope length may be customized upon request. The SwingMe Lounge chair and SwingUs 2-seater may be hung either from a single point, for a rotating swing experience, or from two points, for a back-and-forth one. The canopy for the SwingUs 2-seater fits only when the piece is hung from a single point.

DE HIMMEL

Der SWINGREST Himmel besteht aus 100% spindüsengefärbtem Outdoor-Acrylstoff mit einer Lichtechtheit von 7/8. Dank einer Teflon®-Beschichtung ist der Stoff schimmel-, schmutz- und wasserabweisend. Der Aluminiumring ist mit einem Seil umwickelt.

AUFHÄNGUNG

Die Seillänge kann auf Anfrage nach Kundenwünschen angepasst werden. Der SwingMe Sessel und das SwingUs 2er-Sofa können entweder an einem oder zwei Hängepunkten befestigt werden. Dadurch werden rotierende oder geradlinige Schaukelbewegungen erzielt. Der Himmel für das SwingUs 2er-Sofa kann nur befestigt werden, wenn das Möbelstück an einem einzigen Hängepunkt montiert wurde.

ES VELO

El velo SWINGREST está hecho de tejido acrílico 100% teñido en masa para exteriores con una solidez de color de 7/8. Cuenta con un acabado de Teflon® resistente al moho, la suciedad y el agua. La anilla de aluminio está revestida con cuerda acrílica.

SUSPENSIÓN

Se puede personalizar la longitud del cordón de acuerdo a los requisitos del cliente bajo pedido. El sillón bajo SwingMe y el sofá de dos plazas SwingUs pueden colgarse en un solo punto para obtener un movimiento rotatorio o en dos puntos para conseguir un movimiento de balanceo. El baldaquín para el sofá de dos plazas SwingUs solo se puede fijar si este está colgado de un solo punto.

* EN ATTENTION Weight capacity 120 kg/265 lbs
** Weight capacity 150 kg/331 lbs
*** Weight capacity 240 kg/530 lbs

DE ACHTUNG Tragkraft 120 kg/265 lbs
Tragkraft 150 kg/331 lbs
Tragkraft 240 kg /530 lbs

ES ATENCIÓN Capacidad de carga 120 kg/265 lbs
Capacidad de carga 150 kg/331 lbs
Capacidad de carga 240 kg/530 lbs



TANGO

Design by RICHARD FRINIER, 2003

Bold curves and a rhythmic herringbone weave convey dynamism. With elements for a wide range of settings, from dining area to lounge to poolside.



Armchairs

Typology

cm inch

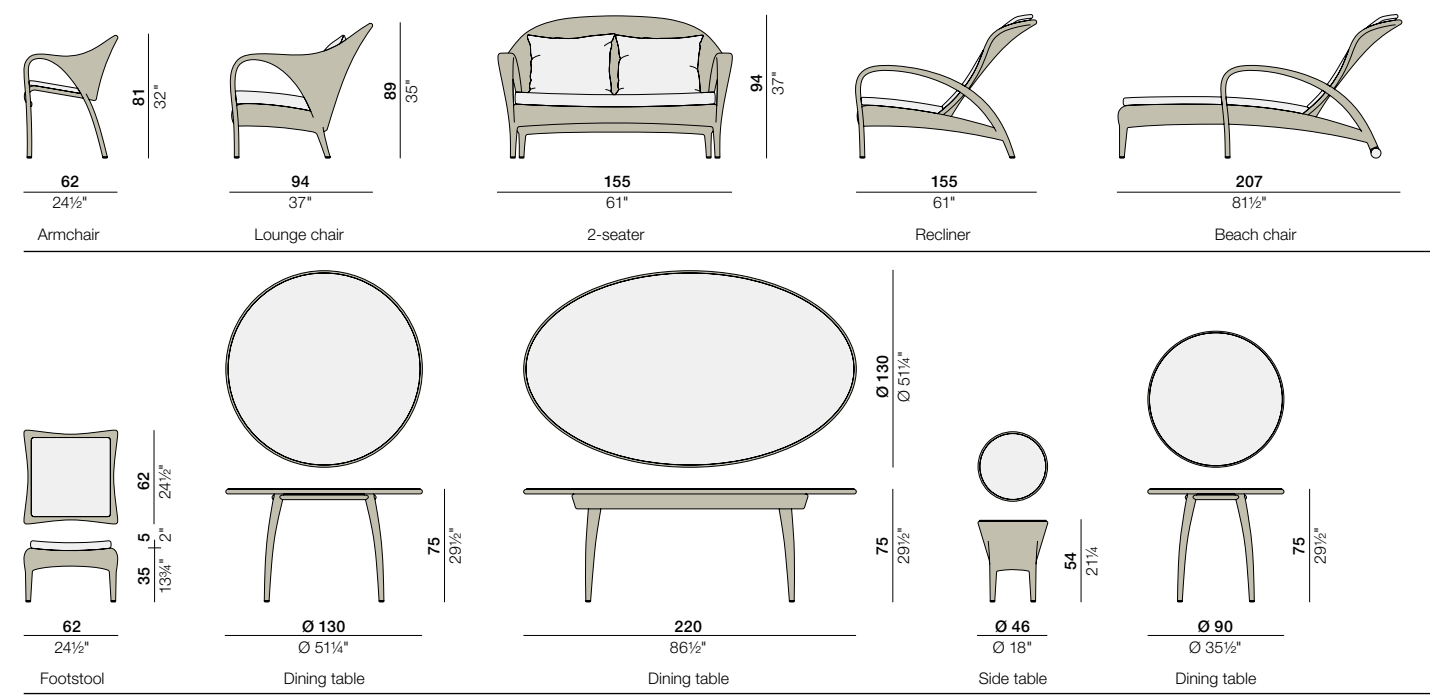

TANGO

Design by RICHARD FRINIER, 2003



Armchair basalto
Cushion: COOL white
Lounge chair basalto

Materials

Recommended combinations



Tabletop glass

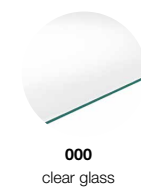

RRP/UVF/PVPR

ARMCHAIR
Armlehnstuhl
Silla con brazos

6 kg
13 lbs

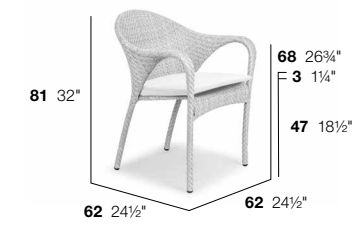

SEAT CUSHION
Sitzkissen
Cojín de asiento

46 × 42 cm
18" × 16½"

026001

DINING TABLE
Esstisch
Mesa comedor

Ø 90 cm
16 kg
Ø 35½"
35 lbs



95026001

56026001000

DINING TABLE
Esstisch
Mesa comedor

Ø 130 cm
29 kg
Ø 51¼"
64 lbs



56026046000

DINING TABLE
Esstisch
Mesa comedor

130 × 220 cm
55,5 kg
51¼" × 86½"
123 lbs

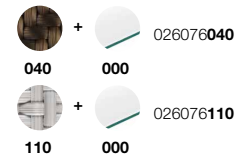

56026050000

LOUNGE CHAIR
Sessel
Sillón bajo

9 kg
20 lbs



SEAT CUSHION + BACK CUSHION
Sitzkissen + Rückenkissen
Cojín de asiento + Cojín de respaldo

61 × 58 cm + 50 × 60 cm
24" × 22¾" + 19¾" × 23½"

026005

2-SEATER
2er-Sofa
Sofá 2 plazas

15 kg
33 lbs



SEAT CUSHION + 2x BACK CUSHIONS
Sitzkissen + 2x Rückenkissen
Cojín de asiento + 2x Cojines de respaldo

132 × 58 cm + 2x 50 × 60 cm
52" × 22¾" + 2x 19¾" × 23½"

026012

95026012

56026012000

FOOTSTOOL
Hocker
Taburete



040



110

6 kg
13 lbs

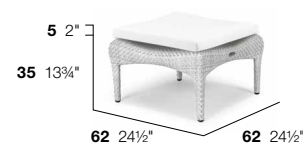

026031110

SEAT CUSHION
Sitzkissen
Cojín de asiento

45 x 45 cm
17 3/4" x 17 3/4"



026031

95026031

56026031000

SIDE TABLE
Beistelltisch
Mesa auxiliar



040



110

+ 026034040

000

+ 026034110

000

Ø 46 cm
6 kg
Ø 18"
13 lbs



Ø 46 Ø 18"
026034110



026034

56026033000

BEACH CHAIR
Sonnenliege
Tumbona



040



110

17 kg
37 lbs



026119110

CUSHION
Kissen
Cojín

60 x 206 cm
23 1/2" x 81"



026119

95026019

56026019000

RECLINER
Liegesessel
Sillón reclinable



040



110

13 kg
29 lbs



026109110

CUSHION
Kissen
Cojín

60 x 136 cm
23 1/2" x 53 1/2"



026109

95026009

56026009000

BEACH CHAIR
Sonnenliege
Tumbona



040



110

17 kg
37 lbs



026119110

CUSHION
Kissen
Cojín

60 x 206 cm
23 1/2" x 81"



026919

95026019

56026019000

RECLINER
Liegesessel
Sillón reclinable



040



110

13 kg
29 lbs



026109110

CUSHION
Kissen
Cojín

60 x 136 cm
23 1/2" x 53 1/2"



026109

95026009

56026009000



For further information please see DEDON.de/TANGO

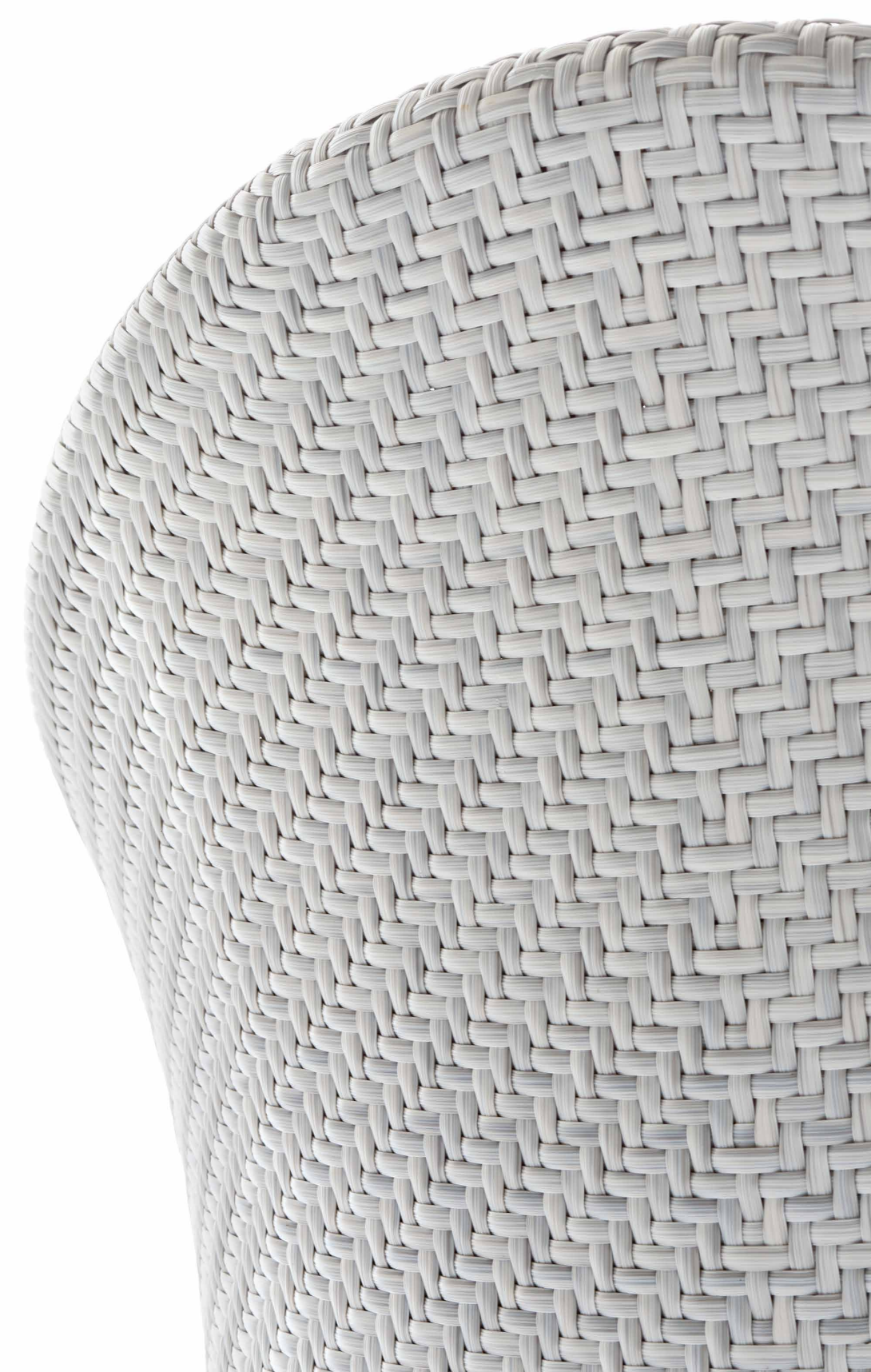



TIBBO

Design by EDWARD BARBER & JAY OSGERBY, 2017

A rich, luxurious, modern collection in premium teak. For dining, lounging and sunbathing.



Armchairs sail shade

Typology

cm inch

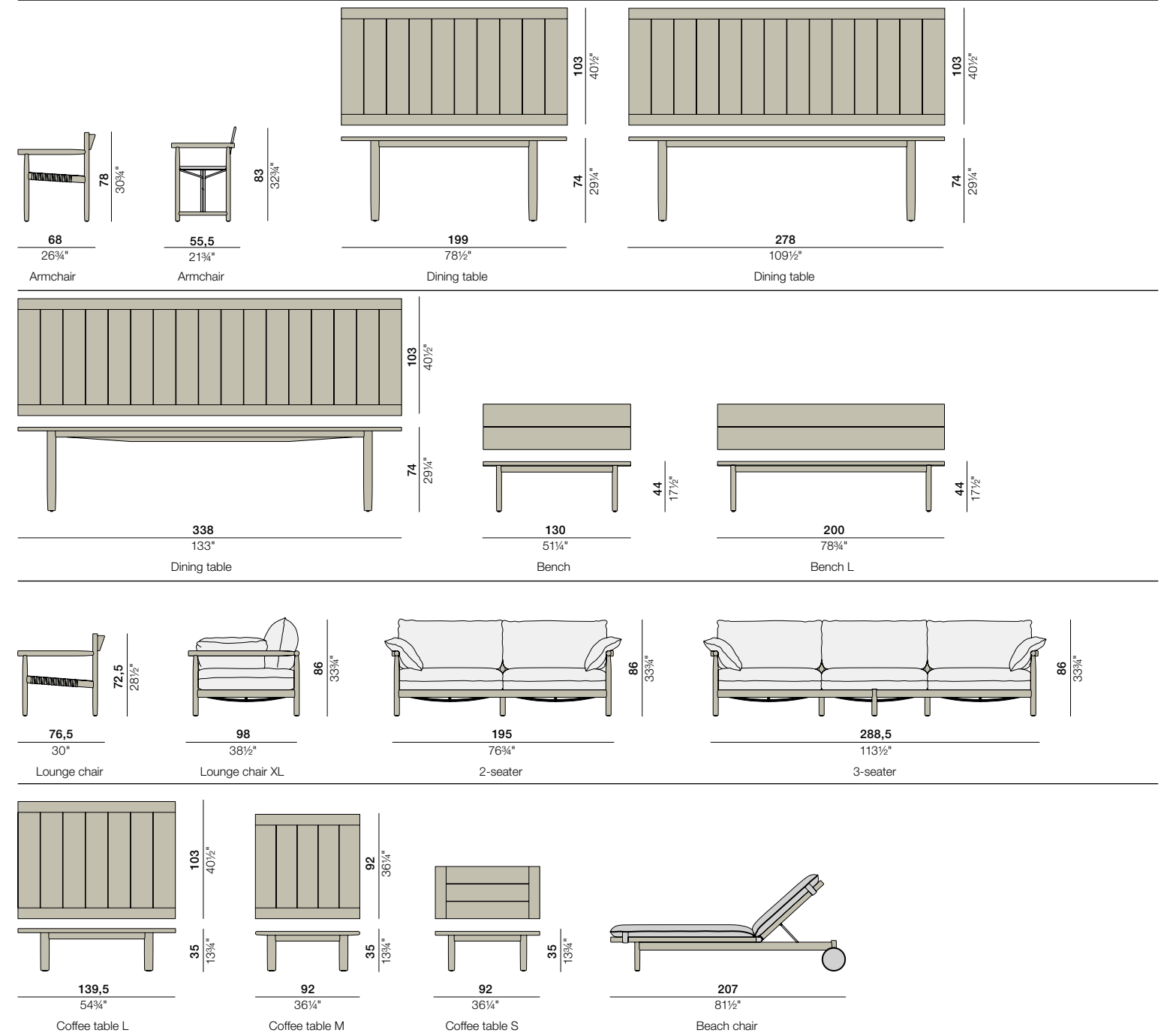

TIBBO

Design by EDWARD BARBER & JAY OSGERBY, 2017



6x Armchair
Cushion: LINEN warm gray
Dining table 103 x 278 cm 40½" x 109½"

Materials

Recommended combinations: dining

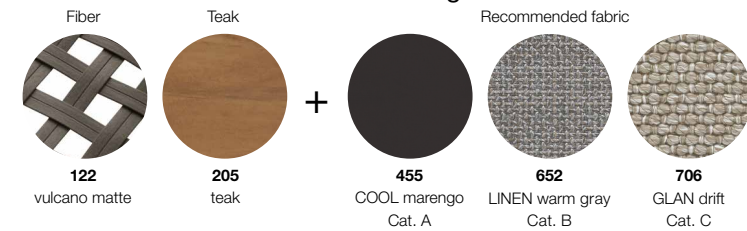

Recommended combinations: lounging

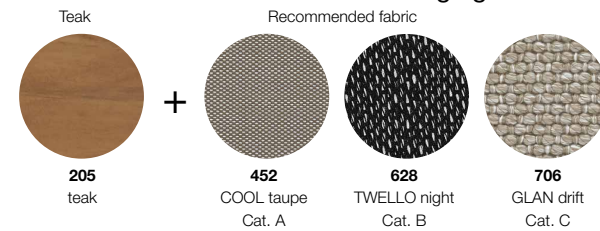

Tabletop



205 teak
TIBBO dining table
TIBBO coffee table

Sling

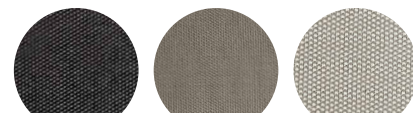

627 sail shade
625 sail taupe
633 sail dove



For further information please see [DEDON.de/TIBBO](https://www.dedon.de/TIBBO)

RRP/UVF/PVPR

ARMCHAIR
Armlehnstuhl
Silla con brazos

7 kg
16 lbs



DRY+ SEAT CUSHION
Dry+ Sitzkissen
Dry+ Cojín de asiento

51 x 50 cm
22" x 20½"

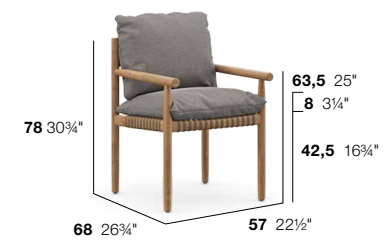

DRY+ CUSHION
Dry+ Kissen
Dry+ Cojín

56 x 102 cm
22" x 40½"

089001122

95089203

95089202



ARMCHAIR
Armlehnstuhl
Silla con brazos

7,2 kg
58 lbs

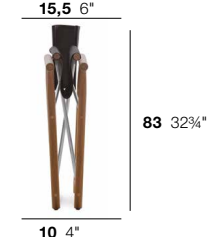
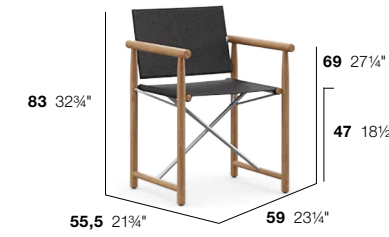
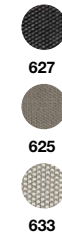

089004

089004627

5608904000

DINING TABLE
Estisch
Mesa comedor

103 x 199 cm
43 kg
40½" x 78½"
95 lbs



089065

089065205

56089065000

DINING TABLE
Estisch
Mesa comedor

103 x 278 cm
56 kg
40½" x 109½"
124 lbs

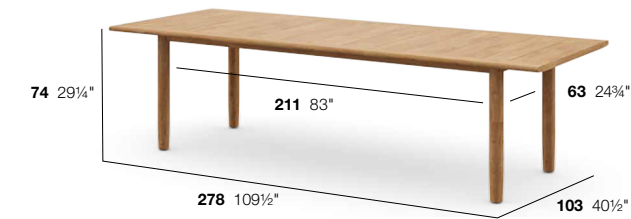

089055

089055205

56089055000

DINING TABLE
Estisch
Mesa comedor

103 x 338 cm
66 kg
40½" x 133"
146 lbs

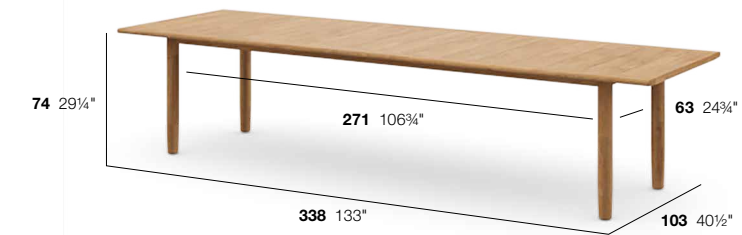

089045

089045205

56089045000

BENCH
Bank
Banco

14 kg
31 lbs



089012

089012205

56089012000

BENCH L
Bank L
Banco L





22 kg
31 lbs









089015



089015205

56089015000

RRP/UV/PVPR				
LOUNGE CHAIR Sessel Sillón bajo		CUSHION Kissen Cojín	  	
9 kg 20 lbs	72,5 28½" 57 22½" 8 3¼" 35 13¾" 76,5 30" 65,5 25¾"	69 × 109,5 cm 21¼" × 43"		
089005	089005122	95089205	56089005000	

LOUNGE CHAIR XL Sessel XL Sillón bajo XL		DRY+ SEAT CUSHION + DRY+ BACK CUSHION + 2x SIDE CUSHIONS Dry+ Sitzkissen + Dry+ Rückenkissen + 2x Seitenkissen Dry+ Cojín de asiento + Dry+ Cojín de respaldo + 2x Cojines lateral	 	
15,4 kg 34 lbs	86 33¾" 57,5 22¾" 20 8" 23 9" 98 38½" 102 40¼"	93 × 95 cm + 47 × 95 cm + 2x 63 × 43 cm 36½" × 37½" + 18½" × 37½" + 2x 24¾" × 17"		
089006	089006122	95089206	56089006000	

2-SEATER 2er-Sofa Sofá 2 plazas		DRY+ SEAT CUSHIONS + DRY+ BACK CUSHIONS + 2x SIDE CUSHIONS Dry+ Sitzkissen + Dry+ Rückenkissen + 2x Seitenkissen Dry+ Cojines de asiento + Dry+ Cojines de respaldo + 2x Cojines lateral	 	
30 kg 66 lbs	86 33¾" 57,5 22¾" 20 8" 23 9" 98 38½" 195 76¾"	190 × 93 cm + 190 × 47 cm + 2x 63 × 43 cm 36½" × 74¾" + 18½" × 74¾" + 2x 24¾" × 17"		
089013	089013122	95089213	56089013000	

3-SEATER 3er-Sofa Sofá 3 plazas		DRY+ SEAT CUSHIONS + DRY+ BACK CUSHIONS + 2x SIDE CUSHIONS Dry+ Sitzkissen + Dry+ Rückenkissen + 2x Seitenkissen Dry+ Cojines de asiento + Dry+ Cojines de respaldo + 2x Cojines lateral	 	
35,4 kg 78 lbs	86 33¾" 57,5 22¾" 20 8" 23 9" 98 38½" 288,5 113½"	285 × 93 cm + 285 × 47 cm + 2x 63 × 43 cm 36½" × 112¼" + 18½" × 112¼" + 2x 24¾" × 17"		
089016	089016122	95089216	56089016000	

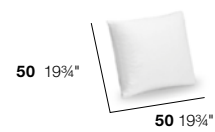

95050082

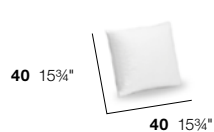

95050081

EN MATERIAL
The frames of the TIBBO armchair and lounge chair are made of premium teak, while the seats consist of woven DEDON Fiber. The beach chair and the foldable armchair have marine-grade stainless steel hinges and connectors, which we recommend cleaning periodically to prevent stains. The foldable armchair comes with a choice of sling material for seat and back. Clean TIBBO products with natural soap dissolved in warm water.

DRY+ CUSHIONS
Dry+ cushions are protected by a highly water-repellent interlayer up to 10,000 mm. The fabric is treated to be stain- and water-repellent.

COVER
The TIBBO beach chair cover can only be used when the backrest is in an upright position.

DE MATERIAL
Die Rahmen der TIBBO Armlehnstühle und Sessel bestehen aus hochwertigem Teakholz, während die Sitzflächen aus geflochtener DEDON-Faser gefertigt werden. Die Scharniere der Sonnenliege und die Verbindungen des faltbaren Armlehnstuhls bestehen aus rostfreiem Stahl (schiffbauliche „marine-grade“ Qualität). Wir empfehlen diese Verbindungen regelmäßig zu reinigen, um Flecken zu vermeiden. Die Rückenlehne und Sitzfläche des faltbaren Armlehnstuhls wird in drei Sling Farben angeboten. Die Möbel der TIBBO Kollektion reinigen Sie mit lauwarmem Wasser unter Hinzugabe von materialschonender Naturseife.



DRY+ KISSEN
Die Dry+ Kissen sind durch eine stark wasserabweisende innere Hülle mit einer Wassersäule von 10.000 mm geschützt. Der Stoff ist so behandelt, dass er schmutz- und wasserabweisend ist.



HUSSEN
Die Husse der TIBBO Sonnenliegen ist nur bei aufgerichteter Rückenlehne zu verwenden.

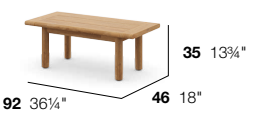

ES MATERIAL
La estructura de la silla y el sillón bajo TIBBO están hechos de madera de teca de alta calidad, mientras que los asientos se componen de fibra tejida DEDON. Las bisagras de la tumbona y las conexiones del sillón plegable son de acero inoxidable (calidad naval "marine grade"). Se recomienda limpiar periódicamente estas uniones para evitar manchas. El respaldo y el asiento del sillón plegable están disponibles en tres colores de tejido sling. Lavar con agua templada y jabón natural en copos bien disueltos.





DRY+ COJINES
Los cojines Dry+ están protegidos con un revestimiento muy impermeable con una resistencia al agua de nada menos que 10.000 mm. La tela está tratada para ser resistente a las manchas y al agua.





FUNDAS
La funda de la tumbona TIBBO solo puede colocarse cuando el respaldo está en posición vertical.

RRP/UV/PVPR				
COFFEE TABLE S Kaffeetisch S Mesa de centro S			 	
92 × 46 cm 11,3 kg 36¼" × 18" 25 lbs	92 36¼" 35 13¾" 46 18"			
089038	089038205		56089038000	

COFFEE TABLE M Kaffeetisch M Mesa de centro M			 	
92 × 92 cm 19 kg 36¼" × 36¼" 42 lbs	92 36¼" 35 13¾" 92 36¼"			
089040	089040205		56089040000	

COFFEE TABLE L Kaffeetisch L Mesa de centro L			 	
103 × 139 cm 28,2 kg 40½" × 54¾" 62 lbs	139 54¾" 35 13¾" 103 40½"			
089037	089037205		56089037000	

BEACH CHAIR Sonnenliege Tumbona		DRY+ CUSHION Dry+ Kissen Dry+ Cojín	  	
25,6 kg 57 lbs	min. 20° 206 81" 11 4¼" 30 11¾" 74 29¼"	75 × 206 cm 81" × 29½"		
089019	089019205	95089219	56089019000	

BEACH CHAIR Sonnenliege Tumbona		DRY+ CUSHION Dry+ Kissen Dry+ Cojín	  	
26 kg 58 lbs	min. 20° 207 81½" 11 4¼" 30 11¾" 74 29¼"	75 × 206 cm 81" × 29½"		
089020	089020205	95089219	56089019000	

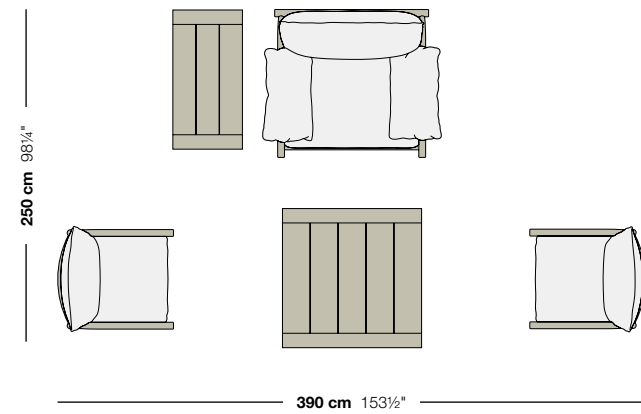

TIBBO Setting 01

- 2x 089005122 – Lounge chair incl. Dry+ cushion
- 1x 089006122 – Lounge chair XL incl. Dry+ cushion
- 1x 089038205 – Coffee table S 92 x 46 cm 36 1/4" x 18"
- 1x 089040205 – Coffee table M 92 x 92 cm 36 1/4" x 36 1/4"

Recommended deco cushions:
 1x 95050082 – 50 x 50 cm 19 3/4" x 19 3/4"

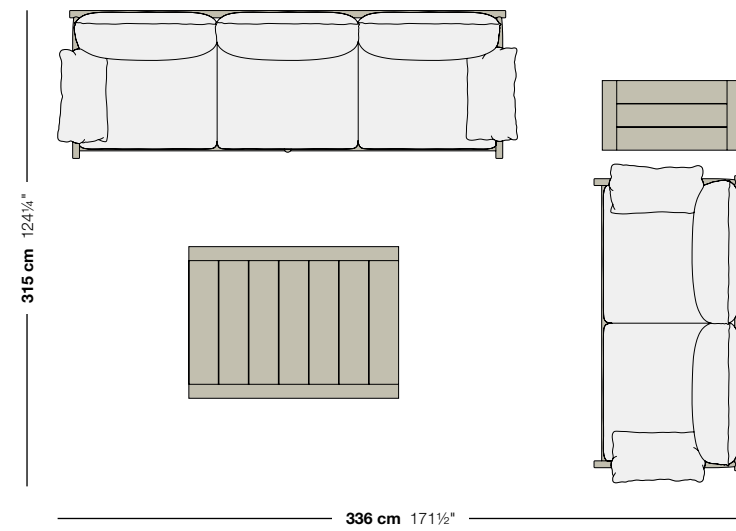

TIBBO Setting 02

- 1x 089013122 – 2-Seater incl. Dry+ cushions
- 1x 089016122 – 3-Seater incl. Dry+ cushions
- 1x 089037205 – Coffee table L 103 x 139 cm 40 1/2" x 54 3/4"
- 1x 089038205 – Coffee table S 92 x 46 cm 36 1/4" x 18"

Recommended deco cushions:
 2x 95050082 – 50 x 50 cm 19 3/4" x 19 3/4"
 2x 95050081 – 40 x 40 cm 15 3/4" x 15 3/4"

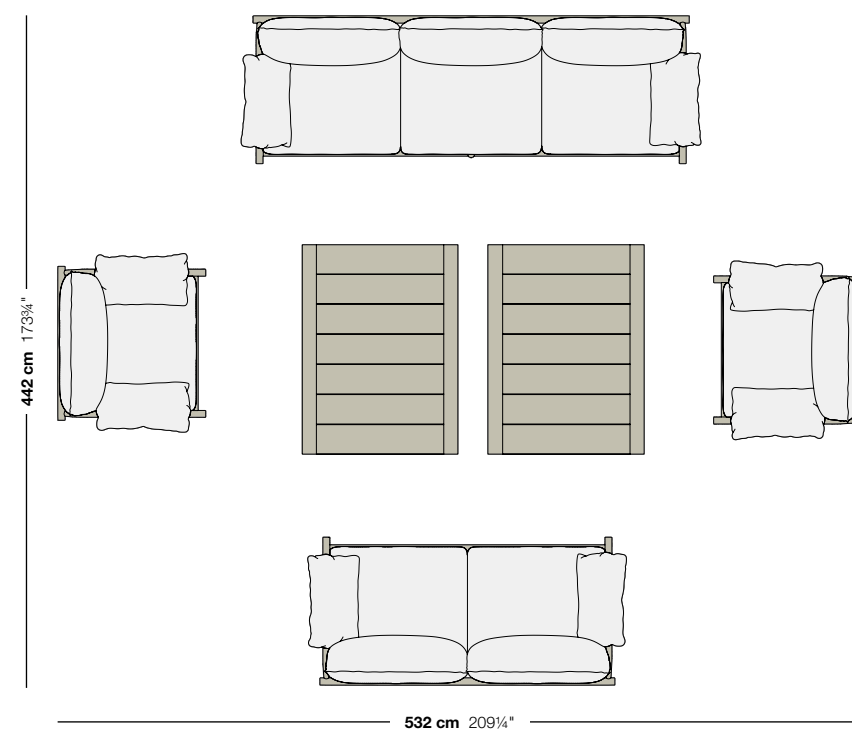

TIBBO Setting 03

- 1x 089016 – 3-Seater incl. Dry+ cushions
- 2x 089006 – Lounge chair XL incl. Dry+ cushions
- 2x 089037205 – Coffee table L 103 x 139 cm 40 1/2" x 54 3/4"
- 1x 089013 – 2-Seater incl. Dry+ cushions

Recommended deco cushions:
 4x 95050081 – 40 x 40 cm 15 3/4" x 15 3/4"
 3x 95050085 – 50 x 40 cm 19 3/4" x 15 3/4"



2-Seater
 Cushion: GLAN drift
 Coffee table S 92 x 46 cm 36 1/4" x 18"
 Coffee table M 92 x 92 cm 36 1/4" x 36 1/4"



WA

Design by TOAN NGUYEN, 2014

A universal dining table collection in various sizes, colors and materials.
A perfect combination with all DEDON dining chair sets.



WA dining table 100 x 200 cm 39¼" x 78¾"
white / HPL white
AIR armchairs salt

Typology

cm inch



100
39¼"

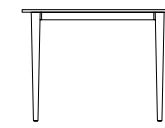

74
29¼"

100
39¼"
Dining table



100
39¼"



74
29¼"

200
78¾"
Dining table

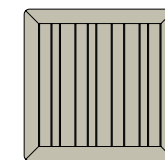

100
39¼"

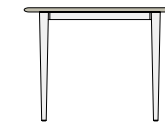

75
29½"

100
39¼"
Dining table teak

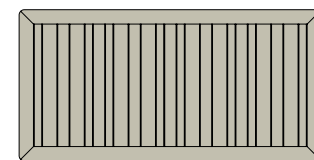

100
39¼"



75
29½"

200
78¾"
Dining table teak

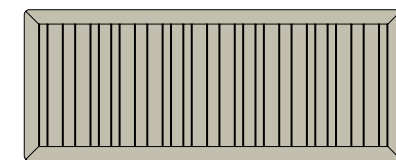

100
39¼"



75
29½"

250
98½"
Dining table teak

WA

Design by TOAN NGUYEN, 2014



Dining table, black pepper / teak
200 x 100 cm 78 3/4" x 39 1/4"

Materials

Frame powder coating

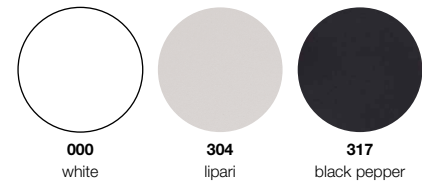

Tabletops HPL

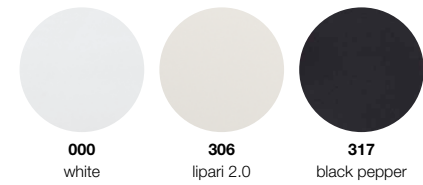

Tabletops glass

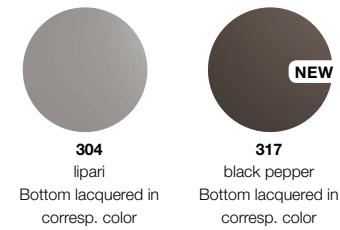

Tabletop teak

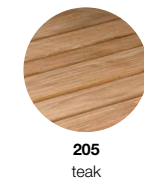

Complementary chairs

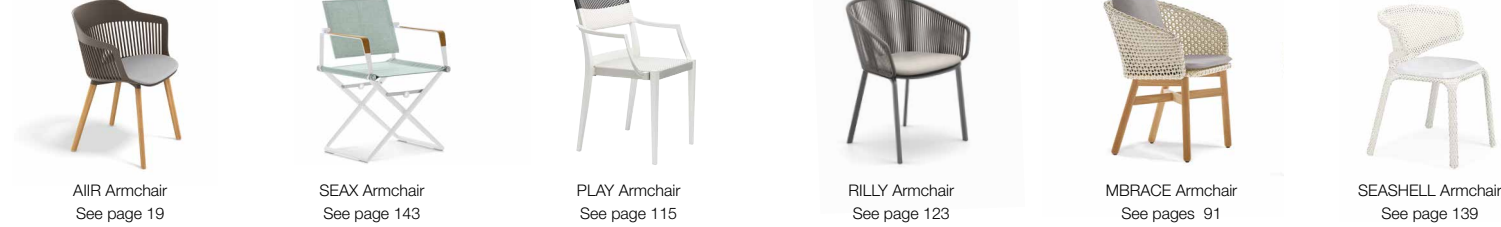

EN MATERIAL
The WA table is available with a high-pressure laminate (HPL) top, a glass top and a teak top. HPL is a non-toxic material that is highly resistant to impact, mechanical stress, moisture and steam. Single-layered tempered glass offers increased resistance to temperature changes as well as excellent resistance to bending, impact and shock. The teak tabletop is made of premium teak. The WA tabletop support structure consists of powder coated aluminum profiles, while the legs consist of die-cast powder coated aluminum. Clean the support structure and legs with a soft cloth and warm water.

DE MATERIAL
Der WA Tisch ist verfügbar mit einer „High Pressure Laminate“ (HPL) Platte, einer Glasplatte sowie einer Teak-Tischplatte. HPL ist ein ungiftiges Material, das sich durch hohe Stoßfestigkeit und extreme Widerstandskraft gegen mechanische Einwirkungen, Feuchtigkeit und Dampf auszeichnet. Das Einscheibensicherheitsglas verfügt über eine verbesserte Temperaturwechselbeständigkeit und weist eine sehr gute Biege-, Schlag- und Stoßfestigkeit auf. Die Teak-Tischplatte besteht aus hochwertigem Teakholz. Die Beine sind aus gegossenem, pulverbeschichtetem Aluminium gefertigt. Einfach mit einem weichen Tuch und warmem Wasser zu reinigen.

ES MATERIAL
Los tableros de la mesa WA están disponibles en tablero laminado a alta presión (HPL), cristal y teca. El HPL es un material no tóxico y muy resistente a impactos, cargas mecánicas, humedad y vapor. El cristal de seguridad monocapa ofrece una alta resistencia a los cambios de temperatura, así como a la flexión, a los impactos y a los golpes. El tablero de teca está hecho con teca de primera calidad. La estructura del soporte del tablero WA está hecha con perfiles de aluminio recubiertos en polvo, mientras que las patas son de aluminio fundido recubierto en polvo. Limpiar la estructura del soporte y las patas con un paño suave y agua tibia.



For further information please see DEDON.de/WA

RRP/UV/PVPR

DINING TABLE
Esstisch
Mesa comedor

100 x 100 cm
39 1/4" x 39 1/4"

34 kg
75 lbs

- 000 + 000 601079001 white / HPL white
- 304 + 306 603079306 lipari / HPL lipari 2.0
- 317 + 317 607079317 black pepper / HPL black pepper



45,5 kg
100 lbs

- 000 + 304 601077098 white / glass lipari
- 304 + 304 603077098 lipari / glass lipari
- 317 + 317 607077317 black pepper / glass black pepper



39,5 kg
65 lbs

- 000 + 205 601060205 white / teak
- 304 + 205 603060205 lipari / teak
- 317 + 205 607060205 black pepper / teak



DINING TABLE
Esstisch
Mesa comedor

100 x 200 cm
39 1/4" x 78 3/4"

50 kg
110 lbs

- 000 + 000 601071001 white / HPL white
- 304 + 306 603071306 lipari / HPL lipari 2.0
- 317 + 317 604071099 black pepper / HPL black pepper

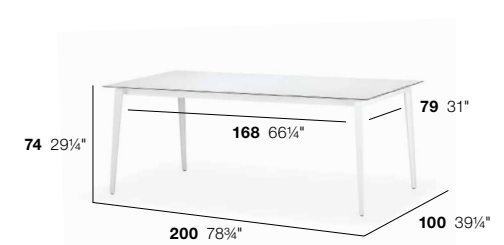

73,5 kg
162 lbs

- 000 + 304 601073098 white / glass lipari
- 304 + 304 603073098 lipari / glass lipari
- 317 + 317 607073317 black pepper / glass black pepper



44 kg
97 lbs

- 000 + 205 601062205 white / teak
- 304 + 205 603062205 lipari / teak
- 317 + 205 607062205 black pepper / teak

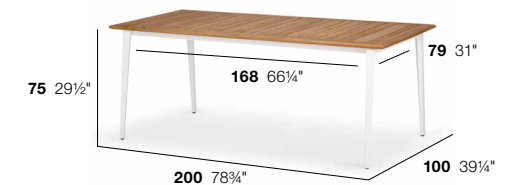

DINING TABLE
Esstisch
Mesa comedor

100 x 250 cm
98 1/2" x 39 1/4"

49,5 kg
109 lbs

- 000 + 205 601064205 white / teak
- 304 + 205 603064205 lipari / teak
- 317 + 205 607064205 black pepper / teak

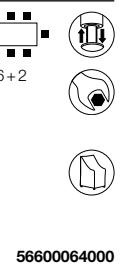
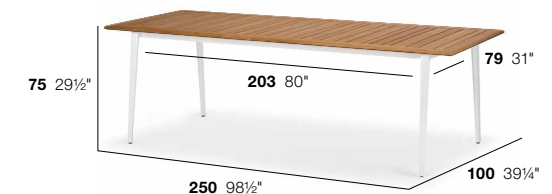

LIGHTING & ACCESSORIES





THE OTHERS

Design by STEPHEN BURKS, 2018

An anthropomorphic lantern collection that ventures into decorative art. Playful, colorful, sculptural and sophisticated.



Lantern M, terra + optional set of eyes, midday
 Statue LIKA + optional set of eyes, midnight
 Lantern S, forest

Typology

cm inch

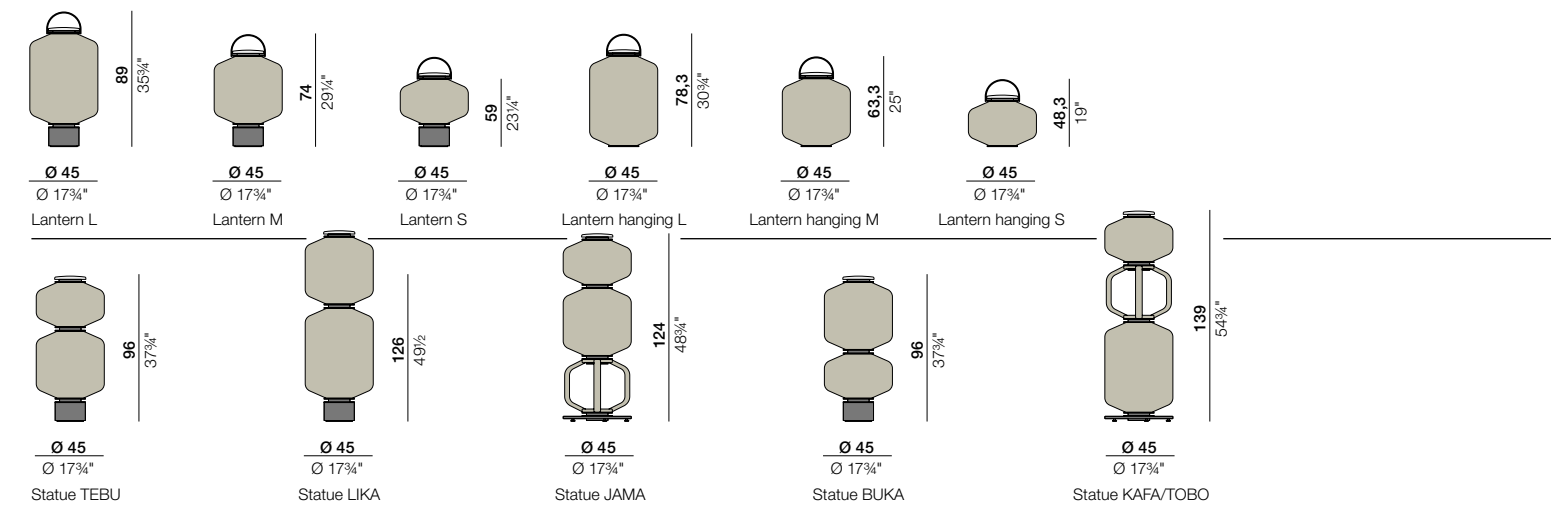

Materials

Fibers lantern S

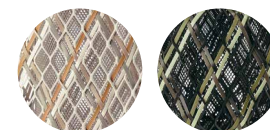

128
cloud

127
forest

Fibers lantern M

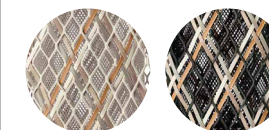

128
cloud

129
terra

Fibers lantern L

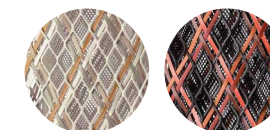

128
cloud

130
rock

Further material



Handmade acrylic eyes, mosaic style

Marble base in nero marquina

Teak spacer



For further information please see DEDON.de/THE_OTHERS

LANTERN S
Laterne S
Farolillo S

10,1 kg
23 lbs

093010128 230 V
093015128 120 V

128

093010127 230 V
093015127 120 V

127

59 23¼"

Ø 45 Ø 17¾"
093010128

LED

☰

☑

☎

☒

LANTERN M
Laterne M
Farolillo M

10,6 kg
24 lbs

093020128 230 V
093025128 120 V

128

093020129 230 V
093025129 120 V

129

74 29¼"

Ø 45 Ø 17¾"
093020128

LED

☰

☑

☎

☒

LANTERN L
Laterne L
Farolillo L

11,2 kg
25 lbs

093030128 230 V
093035128 120 V

128

093030130 230 V
093035130 120 V

130

89 35"

Ø 45 Ø 17¾"
093030128

LED

☰

☑

☎

☒

LANTERN HANGING S
Hängende Laterne S
Farolillo colgante S

3 kg
7 lbs

093040128 230 V
093045128 120 V

128

093040127 230 V
093045127 120 V

127

48 19"

Ø 45 Ø 17¾"
093040128

LED

☰

☑

☎

☒

LANTERN HANGING M
Hängende Laterne M
Farolillo colgante M

3,6 kg
8 lbs

093050128 230 V
093055128 120 V

128

093050129 230 V
093055129 120 V

129

63 24¾"

Ø 45 Ø 17¾"
093050128

LED

☰

☑

☎

☒

LANTERN HANGING L
Hängende Laterne L
Farolillo colgante L

4,2 kg
10 lbs

093060128 230 V
093065128 120 V

128

093060130 230 V
093065130 120 V

130

78 30¾"

Ø 45 Ø 17¾"
093060128

LED

☰

☑

☎

☒

OPTIONAL SET OF EYES

Optionales Augenset
Kit opcional de ojossunrise
093092001midday
093092002midnight
093092003

093092

EN FUNCTION

This **lighting object** is a decorative element for outdoor and indoor use and features a warm white correlated color temperature (2700 Kelvin).

LED-Module: The LED-module has an ingress protection marking by IP64, which means it is dustproof, splashproof and therefore fully suitable for outdoor use. **Energy efficiency** EEC A+. The LED module can be charged in two ways: by solar panel or power adapter. The luminaries contain built-in LED lamps that cannot be replaced. Supplied with a 230V standard plug (Europe) or 120V standard plug (USA).

MATERIAL

THE OTHERS components are made with DEDON Fiber, premium teak, Italian marble and acrylic mosaic. Clean teak using natural soap dissolved in warm water. Custom-made compositions may be specially ordered.

DE FUNKTION

Diese **Leuchte** ist ein dekoratives Objekt für den Innen- und Außenbereich mit einer warmweißen Farbtemperatur (2700 Kelvin).

LED-Modul: Das LED-Modul hat die Schutzklasse IP64 gegen Eindringen von Wasser und Schmutz, ist also staubdicht und spritzwassergeschützt und somit absolut geeignet für den Einsatz im Außenbereich. Aufladen lassen sich die LED-Module auf zweierlei Arten: über Solarmodule oder ein Netzkabel. **Energieeffizienzklasse** EEK A+. Die Leuchten enthalten eingebaute LED-Lampen, die nicht ausgetauscht werden können. Lieferung mit 230V Standardstecker (Europa) oder 120V Standardstecker (USA).

MATERIAL

Die Elemente der THE OTHERS Kollektion bestehen aus DEDON-Faser, Premium-Teak, italienischem Marmor und Acrylmosaik. Teak-Elemente mit lauwarmem Wasser reinigen, in dem natürliche Seifenflocken vollständig aufgelöst wurden. Kundenindividuelle Kombinationen sind bestellbar.

ES FUNCIÓN

Esta **lámpara** es un objeto decorativo para exteriores e interiores con una temperatura de color blanco cálido (2700 Kelvin).

Módulo LED: El módulo LED posee la clase de protección IP 64, lo que significa que es a prueba de polvo y de salpicaduras y, por lo tanto, adecuado para su uso en exteriores. **Eficiencia energética:** IEE A+. Estas lámparas incorporan luces LED. Las luces no se pueden sustituir en las lámparas. Entrega con enchufe de 230V estándar europeo o 120V estándar americano.

MATERIAL

Los elementos de THE OTHERS están elaborados con fibra DEDON, teca de primera calidad, mármol italiano y mosaico acrílico. Limpiar la teca con agua tibia después de que el jabón natural se haya disuelto. Se pueden encargar composiciones personalizadas.

STATUE TEBU
Statue TEBU
Estatua TEBU

Ø 45 cm
12,9 kg
Ø 17¾"
29 lbs

093100000 230 V
093105000 120 V

STATUE JAMA
Statue JAMA
Estatua JAMA

Ø 45 cm
13,2 kg
Ø 17¾"
29 lbs

093120000 230 V
093125000 120 V

STATUE BUKA
Statue BUKA
Estatua BUKA

Ø 45 cm
12,9 kg
Ø 17¾"
29 lbs

093130000 230 V
093135000 120 V

STATUE TOBO
Statue TOBO
Estatua TOBO

Ø 45 cm
13,9 kg
Ø 17¾"
31 lbs

093140000 230 V
093145000 120 V

STATUE LIKA
Statue LIKA
Estatua LIKA

Ø 45 cm
14,1 kg
Ø 17¾"
31 lbs

093110000 230 V
093115000 120 V

STATUE KAFA
Statue KAFA
Estatua KAFA

Ø 45 cm
13,5 kg
Ø 17¾"
30 lbs

093150000 230 V
093155000 120 V





LOON

Design by SEBASTIAN HERKNER, 2018

Outdoor lighting with indoor sophistication and personality. A balloon-like reservoir of light with a warm, ambient glow, supported by a base of premium teak.



Floor lamp L
Floor lamp S

Typology

cm inch

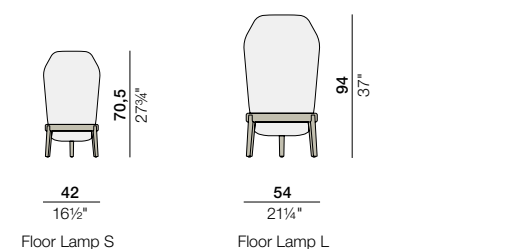

Floor Lamp S

Floor Lamp L

Material



Polyethylene
off white

Teak

For further information please see
DEDON.de/LOON



EN FUNCTION

This **lighting object** is a decorative element for outdoor and indoor use and features a warm white correlated color temperature (2700 Kelvin). **LED-Module:** The LED-module has an ingress protection marking by IP64, which means it is dustproof, splashproof and therefore fully suitable for outdoor use. **Energy efficiency** EEC A+. The luminaires contain built-in LED lamps that cannot be replaced. Supplied with a 230V standard plug (Europe) or 120V standard plug (USA).

MATERIAL

LOON consists of rotomolded polyethylene and a premium teak base. Clean teak base using natural soap dissolved in warm water.

DE FUNKTION

Diese **Leuchte** ist ein dekoratives Objekt für den Innen- und Außenbereich mit einer warmweißen Farbtemperatur (2700 Kelvin). **LED-Modul:** Das LED-Modul hat die Schutzklasse IP64 gegen Eindringen von Wasser und Schmutz, ist also staubdicht und spritzwassergeschützt und somit absolut geeignet für den Einsatz im Außenbereich. **Energieeffizienzklasse** EEK A+. Die Leuchten enthalten eingebaute LED-Lampen, die nicht ausgetauscht werden können. Lieferung mit 230V Standardstecker (Europa) oder 120V Standardstecker (USA).

MATERIAL

LOON besteht aus im Rotationsgussverfahren gefertigtem Polyethylen mit einem Untergestell aus Teak. Das Teak-Gestell mit lauwarmem Wasser reinigen, in dem natürliche Seifenflocken vollständig aufgelöst wurden.

ES FUNCIÓN

Esta **lámpara** es un objeto decorativo para exteriores e interiores con una temperatura de color blanco cálido (2700 Kelvin). **Módulo LED:** El módulo LED posee la clase de protección IP 64, lo que significa que es a prueba de polvo y de salpicaduras y, por lo tanto, adecuado para su uso en exteriores. **Eficiencia energética:** IEE A+. Estas lámparas incorporan luces LED. Las luces no se pueden sustituir en las lámparas. Entrega con enchufe de 230V estándar europeo o 120V estándar americano.

MATERIAL

LOON consiste de una base hecha en teca de primera calidad y una pantalla de polietileno rotomoldeado. Lavar con agua templada y jabón natural en copos bien disuelto.

RRP/UV/PVPR

FLOOR LAMP S
Bodenleuchte S
Lámpara de pie S

Ø 42 cm
3,2 kg
Ø 16 1/2"
8 lbs

70,5 27 3/4"



Ø 42 Ø 16 1/2"

101010000 230 V
101040000 120 V

FLOOR LAMP L
Bodenleuchte L
Lámpara de pie L

Ø 54 cm
6,3 kg
Ø 21 1/4"
14 lbs

94 37"



Ø 54 Ø 21 1/4"

101030000 230 V
101050000 120 V





BABYLON

Design by HARRY-PAUL, 2018

Outdoor lighting characterized by iconic, sculptural, seemingly collapsing forms. Another member of the BABYLON family, which also includes planters and ceramic side tables.



Side table PE, incl. light

Typology

cm inch

Material

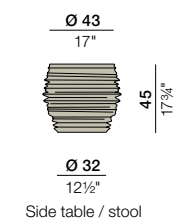

Side table / stool



Polyethylene
off white

For further information please see
[DEDON.de/BABYLON](https://www.dedon.de/BABYLON)



EN FUNCTION

This **lighting object** is a decorative element for outdoor and indoor use and features a warm white correlated color temperature (2700 Kelvin). **LED-Module:** The LED-module has an ingress protection marking by IP64, which means it is dustproof, splashproof and therefore fully suitable for outdoor use. **Energy efficiency** EEC A+. The luminaires contain built-in LED lamps that cannot be replaced. Supplied with a 230V standard plug (Europe) or 120V standard plug (USA).

MATERIAL

BABYLON PE consists of rotomolded polyethylene.

RRP/UV/PVPR

STOOL / SIDE TABLE PE, INCL. LIGHT
Hocker / Beistelltisch PE, inkl. Licht
Asiento / Mesa auxiliar PE, lámpara incluida

Ø 52,5 cm
5,3 kg
Ø 20 3/4"
12 lbs

053112000 230 V
053114000 120 V

DE FUNKTION

Diese **Leuchte** ist ein dekoratives Objekt für den Innen- und Außenbereich mit einer warmweißen Farbtemperatur (2700 Kelvin). **LED-Modul:** Das LED-Modul hat die Schutzklasse IP64 gegen Eindringen von Wasser und Schmutz, ist also staubdicht und spritzwassergeschützt und somit absolut geeignet für den Einsatz im Außenbereich. **Energieeffizienz:** EEK A+. Die Leuchten enthalten eingebaute LED-Lampen, die nicht ausgetauscht werden können. Lieferung mit 230V Standardstecker (Europa) oder 120V Standardstecker (USA).

MATERIAL

BABYLON PE ist aus rotationsgussgefertigtem Polyethylen (PE) hergestellt.

ES FUNCIÓN

Esta **lámpara** es un objeto decorativo para exteriores e interiores con una temperatura de color blanco cálido (2700 Kelvin). **Módulo LED:** El módulo LED posee la clase de protección IP 64, lo que significa que es a prueba de polvo y de salpicaduras y, por lo tanto, adecuado para su uso en exteriores. **Eficiencia energética:** IEE A+. Estas lámparas incorporan luces LED. Las luces no se pueden sustituir en las lámparas. Entrega con enchufe de 230V estándar europeo o 120V estándar americano.

MATERIAL

La colección BABYLON PE está fabricada de polietileno rotomoldado.



Ø 32 Ø 12 1/2"



BABYLON PLANTER

Design by HARRY-PAUL, 2012

Extra-large, artfully asymmetrical, and uncompromisingly modern. Crafted from 100% recyclable rotomolded polyethylene and easy to maintain.



Typology

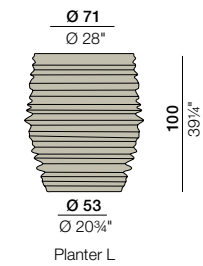

EN MATERIAL
The BABYLON Planter is a dual-walled planter the volume of which can vary depending on the size of the plant. Made of rotomoulded polyethylene (PE): 100% approved for outdoor use, easy to maintain, 100% recyclable, light yet robust at the same time.

DE MATERIAL
Der BABYLON Planter ist ein doppelwandiger Übertopf, dessen Volumen je nach Pflanzengröße variiert werden kann. Aus rotationsguss-gefertigtem Polyethylen (PE) hergestellt: 100% Outdoor-Verwendung, einfach zu pflegen, gleichzeitig leicht und widerstandsfähig, 100% recyclingfähig.

ES MATERIAL
BABYLON Planter es un macetero de pared doble cuyo volumen puede variar según el tamaño de la planta. Fabricado en polietileno rotomol-deado (PE): 100% para uso en exteriores, de fácil mantenimiento, ligero y al mismo tiempo resistente, 100% reciclable.

For further information please see DEDON.de/BABYLON



Materials



RRP/UVF/PVPR

PLANTER L
Übertopf L
Cubretiesto L

Ø 87 cm
30 kg
Ø 34 1/4"
66 lbs



Ø 53 Ø 20 3/4"
053084300

INTERIOR VIEW
Innenansicht
Vista interior

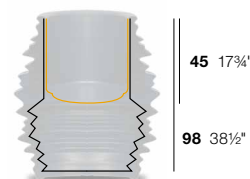

45 17 3/4"

98 38 1/2"

VID

Design by DEDON DESIGN STUDIO, 2017

A beautiful yet durable outdoor rug, crafted by hand and featuring a subtle but sophisticated weaving pattern.

Typology

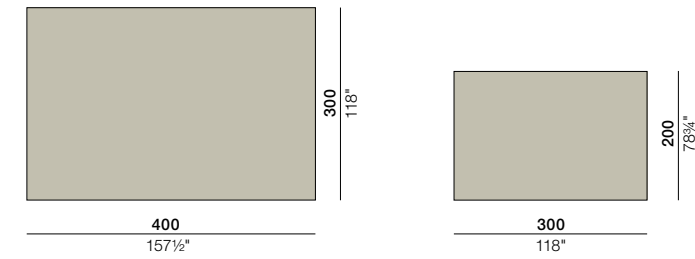

EN MATERIAL
VID is handwoven and consists of 100% polypropylene. Designed and treated for outdoor use, it is UV- and weather-resistant. We recommend to lift the carpet periodically to let it dry.

DE MATERIAL
VID ist handgewebt und besteht aus 100% Polypropylen. Der Teppich ist witterungsbeständig, hat eine hohe UV-Resistenz und eignet sich für den Einsatz im Außenbereich. Wir empfehlen, den Teppich regelmäßig anzuheben, um ihn vollständig zu trocknen.

ES MATERIAL
VID está tejido a mano y está compuesto de 100% polipropileno. La alfombra es resistente a la intemperie, es altamente resistente a los rayos UV y es adecuada para utilizarse al aire libre. Se recomienda levantar periódicamente la alfombra para secarla completamente.

For further information please see DEDON.de/VID



Materials



RRP/UVF/PVPR

CARPET FRINGES
Teppich FRINGES
Alfombra FRINGES

200 x 300 cm
78 3/4" x 118"



098030125



098030124

CARPET SOLID
Teppich SOLID
Alfombra SOLID

200 x 300 cm
78 3/4" x 118"



098020125



098020124

CARPET SOLID
Teppich SOLID
Alfombra SOLID

300 x 400 cm
118" x 157 1/2"



098025125

DALA PLANTER & LANTERN

Design by STEPHEN BURKS, 2013

Planters and outdoor lanterns in three sizes, all matching the mesh structure and artful weaving style of the award-winning DALA furniture collection.



Lantern cuba Ø 34 cm / Ø 13½"
Lantern bahamas Ø 34 cm / Ø 13½"
Planter ibiza Ø 61 cm / Ø 24"

cm inch

Typology

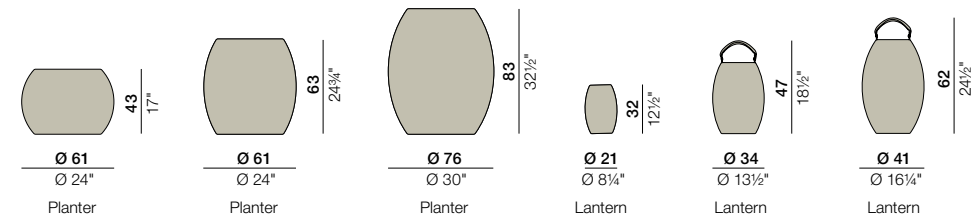

Materials

Combinations

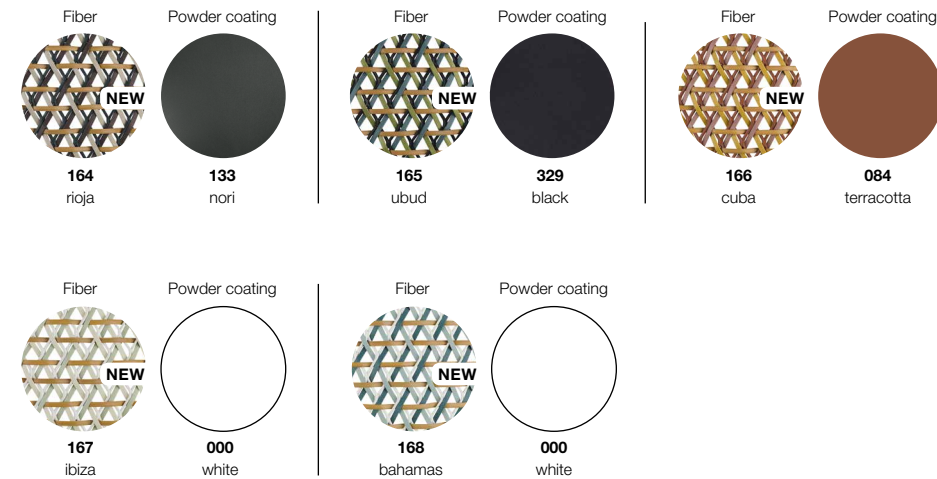

EN MATERIAL
The removable inner planter consists of rotomolded polyethylene. The removable candle holder consists of a metal candle plate and a plastic tube. For the small DALA lantern (height 32 cm / 12½"), use only a block **candle** with a maximum height of 8 cm / 4½" and a maximum diameter of 11 cm / 3¼". For the medium and large DALA lanterns (heights 47 cm / 18½" and 62 cm / 24½"), use only a block candle with a maximum height of 22 cm / 8¾" and a maximum diameter of 17 cm / 6¾".

DE MATERIAL
Der herausnehmbare innere Behälter wurde in Rotationsgusstechnik aus Polyethylen gefertigt. Der herausnehmbare Kerzenhalter besteht aus einem Kerzenteller aus Metall und einem Kerzenschutz aus Kunststoff. Die **Kerzen** sollten für die kleine DALA Laterne (Höhe 32 cm / 12½") eine Höhe von 11 cm / 4½" und einen Durchmesser von 8 cm / 3¼" nicht überschreiten. Die Kerzen für die DALA Laternen mittlerer und großer Größe (Höhe 47 cm / 18½" und 62 cm / 24½") sollten nicht höher als 22 cm / 8¾" sein und einen maximalen Durchmesser von 17 cm / 6¾" nicht überschreiten. Verwenden Sie bitte ausschließlich Blockkerzen.

ES MATERIAL
Recipiente interior extraíble de polietileno rotomoldeado. El portavelas desmontable está compuesto por un plato metálico y un tubo plástico. Para el farolillo DALA pequeño (altura 32 cm / 12½") utilice únicamente una **vela** con una altura máxima de 11 cm / 4½" y un diámetro máximo de 8 cm / 3¼". Para los farolillos DALA mediano y grande (altura 47 cm / 18½" y 62 cm / 24½") utilice únicamente una vela con una altura máxima de 22 cm / 8¾" y un diámetro máximo de 17 cm / 6¾".

RRP/UV/PVPR

PLANTER S
Übertopf S
Cubretiesto S



Ø 61 cm
5 kg
Ø 24"
11 lbs

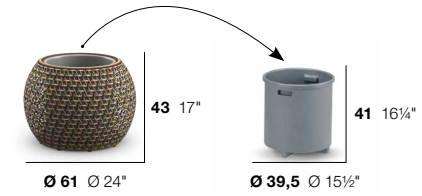

073050

PLANTER M
Übertopf M
Cubretiesto M

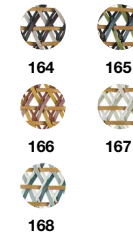

Ø 61 cm
5 kg
Ø 24"
11 lbs



073052

PLANTER L
Übertopf L
Cubretiesto L



Ø 76 cm
8 kg
Ø 30"
18 lbs

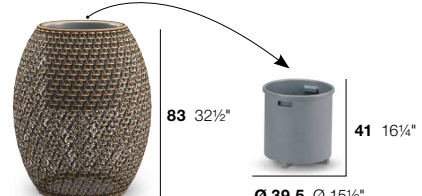

073051

LANTERN
Laterne
Farolillo



Ø 21 cm
1 kg
Ø 8¼"
3 lbs

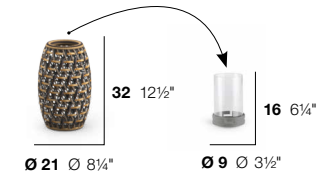

073060

HANGER FOR LANTERN Ø 21 CM / Ø 12½"
Aufhängung für Laterne Ø 21 cm / Ø 12½"
Elemento de suspensión para el farolillo Ø 21 cm / Ø 12½"



073091000

LANTERN
Laterne
Farolillo



Ø 34 cm
2 kg 0
Ø 13½"
5 lbs



073061

HANGER FOR LANTERN Ø 34 CM / Ø 18½" and Ø 41 CM / Ø 24½"
Aufhängung für Laterne Ø 34 cm / Ø 18½" und Ø 41 cm / Ø 24½"
Elemento de suspensión para el farolillo Ø 34 cm / Ø 18½" y Ø 41 cm / Ø 24½"



073092000

LANTERN
Laterne
Farolillo



Ø 41 cm
2,5 kg
Ø 16¼"
6 lbs

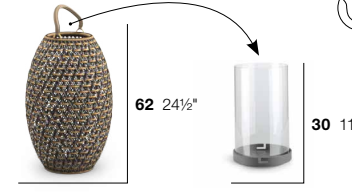

073062



For further information please see DEDON.de/DALA



For more DALA products see page 46

MINI NESTREST

Design by DANIEL POUZET & FRED FRETY, 2012

The MINI NESTREST is a fun addition to the iconic NESTREST collection. Available in fiber colors of natural and chalk, it is a beautiful accessory for the beach or a picnic on the lawn.



Typology

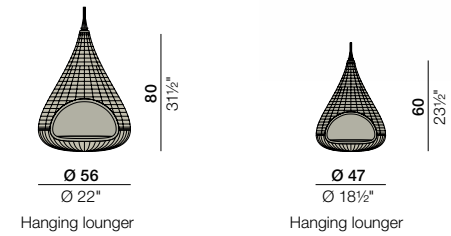

For further information please see DEDON.de/MINI_NESTREST

Materials

Combinations

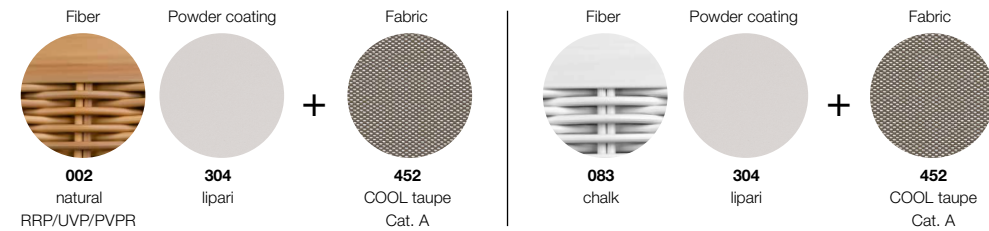

MINI NESTREST, DECORATION ITEM
 Mini Nestrest, Dekorationsartikel
 Mini Nestrest, Delemento de decoración

Ø 47 cm
 Ø 18½"
 2,5 kg
 6 lbs

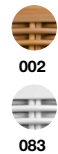

Ø 47 Ø 18½"

60 23½"

090021

090021002

SEAT CUSHION
 Sitzkissen
 Cojín de asiento
 452

MINI NESTREST, DECORATION ITEM
 Mini Nestrest, Dekorationsartikel
 Mini Nestrest, Delemento de decoración

Ø 56 cm
 Ø 22"
 3,5 kg
 8 lbs

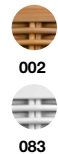

Ø 56 Ø 22"

80 31½"

090022

090022002

SEAT CUSHION
 Sitzkissen
 Cojín de asiento
 452

95090021452

LA MALLE CUSHIONS TRUNK

Design by LORENZA BOZZOLI & THE KINGS, 2012

Made of DEDON Fiber, this unobtrusive and effective storage solution for cushions and upholstery features a handwoven body and a sophisticated interior lining.



Typology

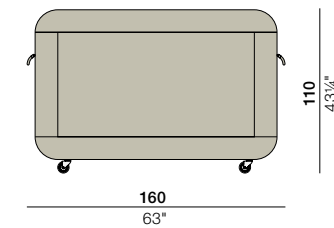

Material

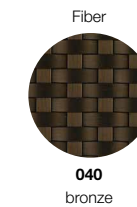

EN FUNCTION

Opening and closing of the lid is assisted by pneumatic springs. All trunks are designed for short-term storage of DEDON cushions and pillows. Ensure the cushions are completely dry before storing them in the trunk. The trunk can be used in covered outdoor areas as well as indoors. Customized XL cushions trunk available in other DEDON weaves and colors, subject to surcharge.

DE FUNKTION

Das Öffnen und Verschließen des Deckels wird durch Gasdruckfedern unterstützt. Alle Truhen dienen einem kurzzeitigen Verstauen der DEDON-Kissen und Polster. Stellen Sie sicher, dass die Kissen vollständig trocken sind, bevor Sie sie in die Truhe legen. Die Truhe ist im überdachten Außenbereich sowie im Innenbereich einsetzbar. Individuell angefertigte Kissenruhe XL in anderen DEDON-Flechtungen und Farben gegen Aufpreis möglich.

ES FUNCIÓN

Unos muelles neumáticos facilitan la apertura y el cierre de la tapa. Todos los baúles sirven para almacenar cojines y acolchados durante un breve periodo de tiempo. Asegúrese de que los cojines estén completamente secos antes de depositarlos en el baúl. El baúl se puede utilizar en exteriores techados y en interiores. El baúl para cojines XL con acabado personalizado se puede adquirir en otras fibras DEDON y colores bajo recargo adicional.

RRP/UVPP/PVPR

CUSHIONS TRUNK XL
 Kissenruhe XL
 Baúl para cojines XL

66,5 kg
 147 lbs



INTERIOR DIMENSIONS (W x H x D)
 Abmessungen innen (B x H x T)
 Dimensiones interiores (a x a x f)

152 x 82 x 87 cm
 59¾" x 32¼" + 34¼"

072010



REAV

Design by DEDON DESIGN STUDIO, 2019

Minimalist sun shades supported by smooth engineering and robust functionality.
Available in parasol and cantilevered versions.



Square M - cantilever, anthracite

Typology

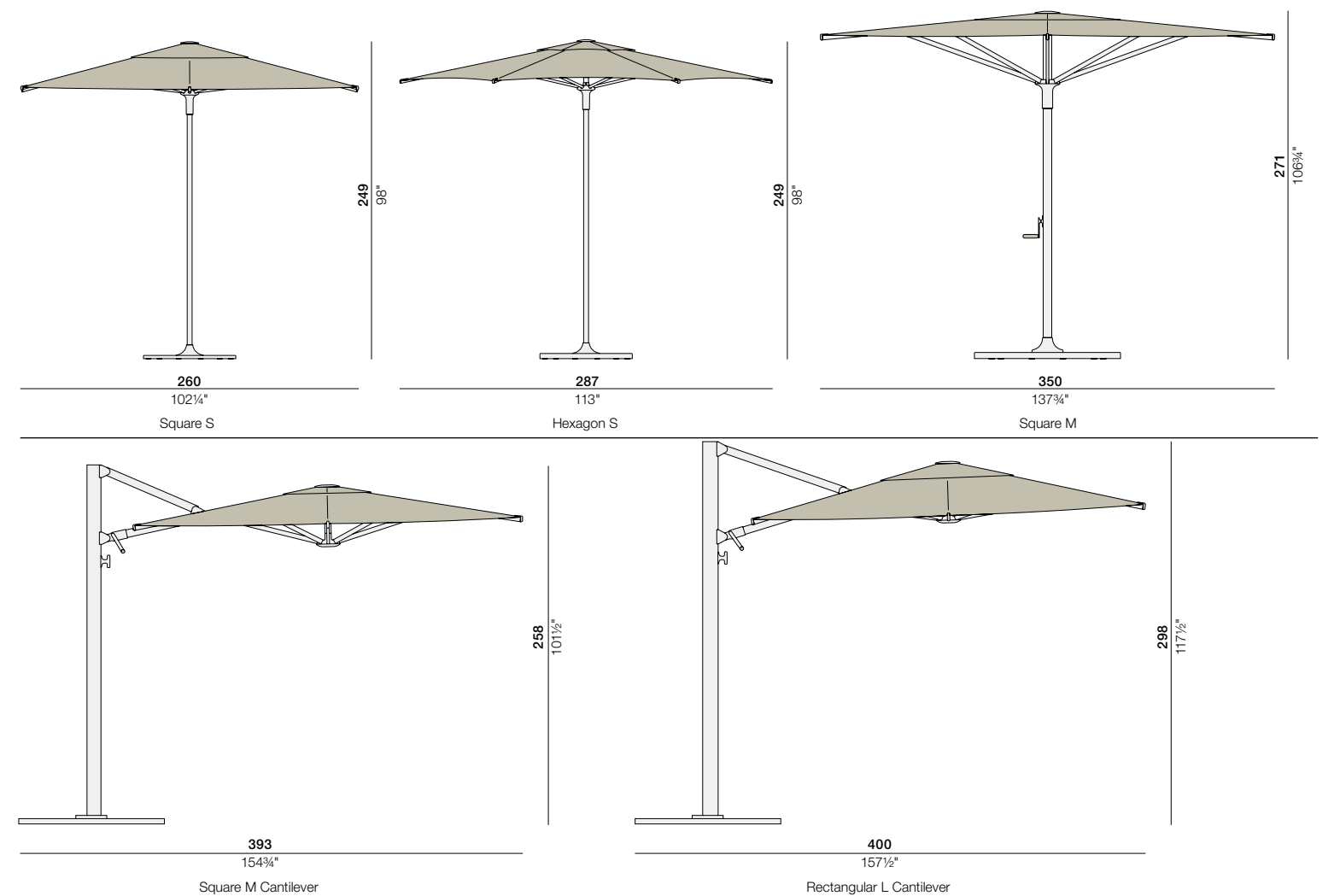

REAV

Design by DEDON DESIGN STUDIO, 2019



Square M anthracite

Materials

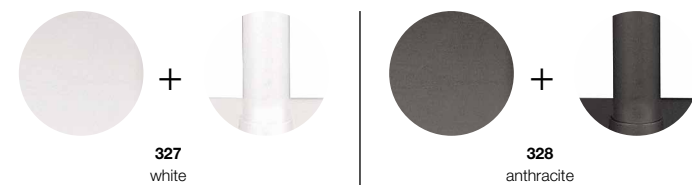

EN WIND GRADE

This item is available in two base configurations, for wind grade 3 (12-19 km/h/7.5-12 mph) or wind grade 6 (39-49 km/h/24-30 mph), the latter featuring additional steel weights. See icon for number of wind force.

MOUNTING KITS

Mounting kits will achieve wind grade 6 (39-49 km/h/24-30 mph) and are available for square M, square M cantilever and rectangular L cantilever only. For further ground mounting safety instructions, please consult the assembly instruction. It is the responsibility of the customer to provide a safe and suitable foundation.

DE WINDSTÄRKE

Das Produkt ist mit zwei verschiedenen Ständervarianten erhältlich, die für Windstärke 3 (12-19 km/h/7.5-12 mph) bzw. Windstärke 6 (39-49 km/h/24-30 mph) geeignet sind; letztere Variante ist mit zusätzlichen Stahlgewichten ausgestattet. Die Windstärke ist mit einem Symbol angegeben.

BODENMONTAGESATZ

Mit einem Bodenmontagesatz wird ebenfalls Standsicherheit bei Windstärken bis 6 (39-49 km/h/24-30 mph) erreicht. Der Montagesatz ist nur für die Modelle Square M, Square M Cantilever und Rectangular M Cantilever erhältlich. Weitere Sicherheitshinweise für die Bodenmontage finden Sie in der Montageanleitung. Es obliegt dem Kunden, für einen geeigneten, sicheren Untergrund zu sorgen.

ES FUERZA DEL VIENTO

Este producto está disponible en dos configuraciones posibles para la base: para una fuerza del viento 3 (12-19 km/h/7.5-12 mph) o una fuerza del viento 6 (39-49 km/h/24-30 mph). En el último caso, también cuenta con pesos de acero adicionales. Ver icono para encontrar el número de la fuerza del viento.

KITS DE MONTAJE

Los kits de montaje resisten una fuerza 6 (39-49 km/h/24-30 mph) y solo están disponibles para el cantilever cuadrado M y el cantilever rectangular L. Para más instrucciones de seguridad sobre el montaje en el suelo, consulte las instrucciones de ensamblaje. Es la responsabilidad del cliente garantizar que los cimientos sean seguros y adecuados.



For further information please see DEDON.de/REAV

RRP/UVF/PVPR

SQUARE S

260 x 260 cm
102 1/4" x 102 1/4"

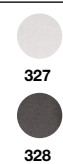

249 98"
210 82 3/4"



260 102 1/4"



79 kg
174 lbs

252 99 1/4"
210 82 3/4"



260 102 1/4"

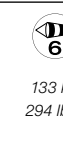

133 kg
294 lbs

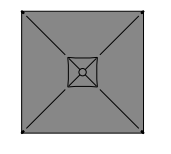

260 102 1/4"



included

106016328

106017328

HEXAGON S

287 x 260 cm
113" x 102 1/4"



249 98"
210 82 3/4"



287 113"



79 kg
174 lbs

252 99 1/4"
210 82 3/4"



287 113"



133 kg
294 lbs

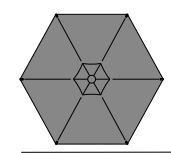

287 113"

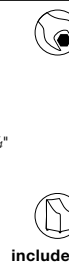

included

106026328

106027328

SQUARE M

350 x 350 cm
137 3/4" x 137 3/4"



271 106 3/4"
227 89 1/4"



350 137 3/4"



255 kg
562 lbs

350 137 3/4"

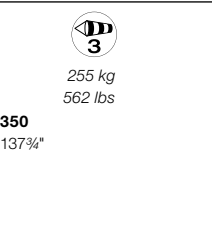

350 137 3/4"



405 kg
893 lbs

In-ground mounting kit
(Parasol without base)

Concrete mounting kit
(Parasol without base)



included

106038328

106039328

106094328

106095328

SQUARE M - CANTILEVER

300 x 300 cm
118" x 118"



258 101 1/2"
208 82"



393 154 3/4"



262 kg
578 lbs

300 118"

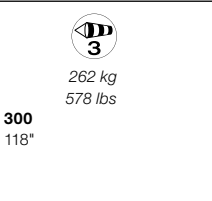

300 118"



410 kg
904 lbs

In-ground mounting kit
(Cantilever without base)

Concrete mounting kit
(Cantilever without base)



included

106058328

106059328

106096328

106097328

RECTANGULAR L - CANTILEVER

302 x 400 cm
119" x 157 1/2"



298 117 1/2"
284 111 3/4"



400 157 1/2"



420 kg
926 lbs

302 119"

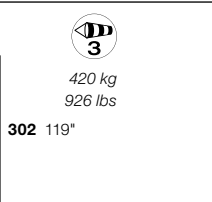

302 119"



In-ground mounting kit
(Cantilever without base)

Concrete mounting kit
(Cantilever without base)



included

106089328

106090328

106091328

IN-GROUND MOUNTING KIT

Montagesatz zur Bodenbefestigung im Erdboden
Kit de montaje bajo suelo

7,8 kg
17 lbs

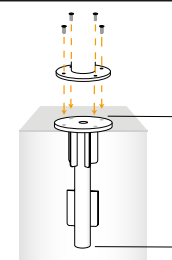

106092000

CONCRETE MOUNTING KIT

Montagesatz zur Bodenbefestigung im Betonboden
Kit de montaje en hormigón

4,8 kg
11 lbs

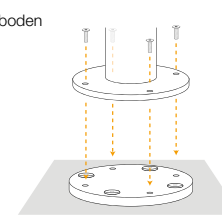

106093000

CONTRACT COLLECTIONS





CAIRO

Design by NICOLAS THOMKINS, 2010

Stackable design and a lightweight yet sturdy construction. Finished in hand-woven DEDON Fiber in a choice of colors.



Beach chair, taupe light
Cushion: COOL taupe

Typology

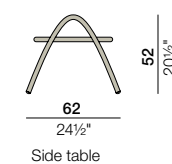
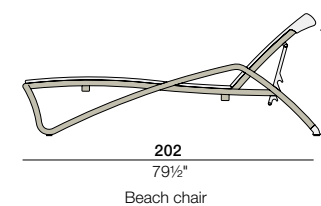

cm inch

Materials

Fibers

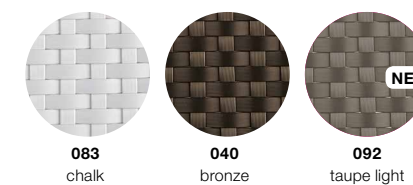

RRP/UVF/PVPR

BEACH CHAIR
Sonnenliege
Tumbona

16 kg
35 lbs

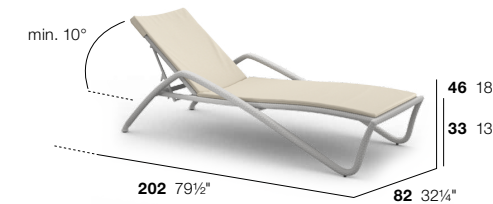

SEAT CUSHION + BACK CUSHION
Sitzkissen + Rückenkissen
Cojín de asiento + Cojín de respaldo
127 x 66 x 2 cm + 58 x 68 x 2 cm
50" x 26" x ¾" + 22¾" x 26¾" x ¾"

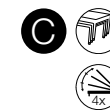

95016019

127 x 66 x 5 cm + 58 x 68 x 5 cm
50" x 26" x 2" + 22¾" x 26¾" x 2"

95016119

016019

016019083

SIDE TABLE
Beistelltisch
Mesa auxiliar

3,4 kg
7 lbs

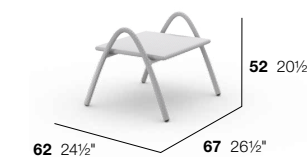

016033

016033083



FEDRO

Design by LORENZA BOZZOLI, 2013

This innovative chair without legs represents a new concept in seating. It is lightweight, ergonomic and portable.



3x Floor rocker

Typology

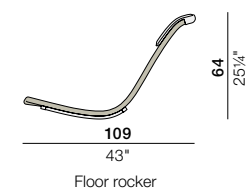

Floor rocker

cm inch

Materials

Fibers

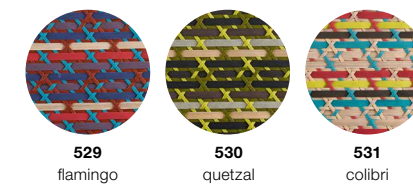

RRP/UVF/PVPR

FLOOR ROCKER
Floor rocker
Floor rocker

5,2 kg
12 lbs

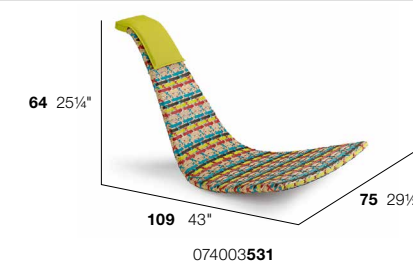
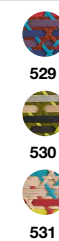

HEADREST CUSHION
Nackenkissen
Cojín reposacabezas



included

074003

EN FABRICS
The headrest cushion consists of quick-drying foam covered in Batyline® fabric.

DE STOFFE
Das Nackenkissen besteht aus schnell trocknendem Schaumstoff mit einem Überzug aus Batyline®-Stoff.

ES TEJIDOS
El cojín reposacabezas es de espuma de secado rápido y está tapizado con tejido Batyline®.

56074003000

CONTRACT



HOLIDAY

Design by RICHARD FRINIER, 2006

Simple, sturdy, lightweight and versatile, with elements for dining, bar, beach and pool. Blends naturally with any decor.



2x Armchair, chalk

CONTRACT

Typology

cm inch

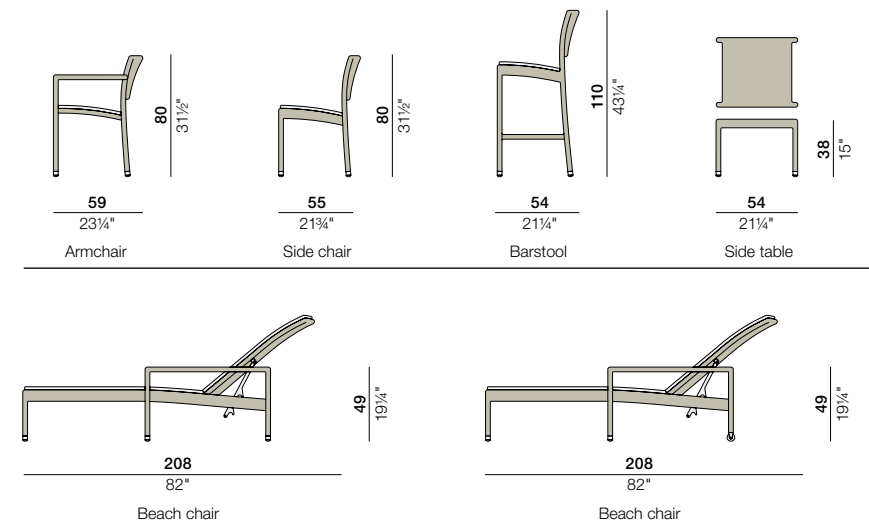

Design by RICHARD FRINIER, 2006



Beach chair bronze

Materials

Fibers



083
chalk



040
bronze



092
taupe light

RRP/UVF/PVPR

ARMCHAIR
Armlehnstuhl
Silla con brazos

5,2 kg
11 lbs

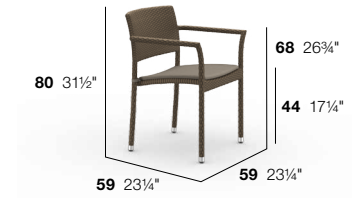

042001040

SEAT CUSHION
Sitzkissen
Cojín de asiento
40 x 43 x 2 cm
15 3/4" x 17" x 3/4"

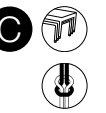

95042001
40 x 43 x 5 cm
15 3/4" x 17" x 2"

042001

SIDE CHAIR
Esststuhl
Silla de comedor

4 kg
8 lbs

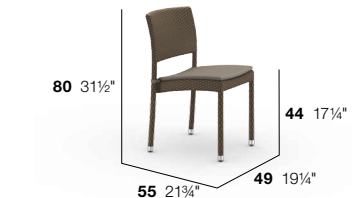

042003040

SEAT CUSHION
Sitzkissen
Cojín de asiento
44 x 38 x 2 cm
17 1/4" x 15" x 3/4"

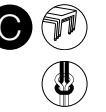

99042003
44 x 38 x 5 cm
17 1/4" x 15" x 2"

042003

BARSTOOL, INCL. ALUMINUM FOOTREST
Barhocker, inkl. Aluminium-Fußstütze
Taburete de bar, incl. reposapiés en aluminio

6,6 kg
14 lbs



042028040

SEAT CUSHION
Sitzkissen
Cojín de asiento
43 x 43 x 2 cm
17" x 17" x 3/4"

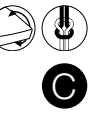

99042028
43 x 43 x 5 cm
17" x 17" x 2"

042028

SIDE TABLE
Beistelltisch
Mesa auxiliar

54 x 46 cm
3 kg
21 1/4" x 18"
7 lbs

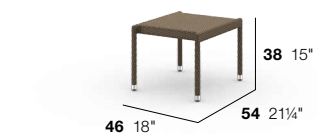

042033040



042033

BEACH CHAIR
Sonnenliege
Tumbona

14,3 kg
31 lbs

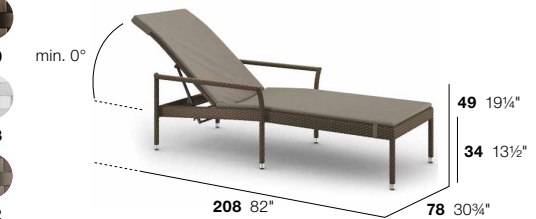

042019040

SEAT CUSHION + BACK CUSHION
Sitzkissen + Rückenkissen
Cojín de asiento + Cojín de respaldo
59 x 116 x 2 cm + 52 x 86 x 2 cm
23 1/4" x 45 3/4" x " + 20 1/2" x 33 3/4" x 3/4"

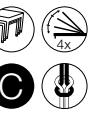

95042019
59 x 116 x 5 cm + 52 x 86 x 5 cm
23 1/4" x 45 3/4" x 2" + 20 1/2" x 33 3/4" x 2"

042019

BEACH CHAIR
Sonnenliege
Tumbona

14,3 kg
31 lbs



042020040

SEAT CUSHION + BACK CUSHION
Sitzkissen + Rückenkissen
Cojín de asiento + Cojín de respaldo
59 x 116 x 2 cm + 52 x 86 x 2 cm
23 1/4" x 45 3/4" x " + 20 1/2" x 33 3/4" x 3/4"



95042019
59 x 116 x 5 cm + 52 x 86 x 5 cm
23 1/4" x 45 3/4" x 2" + 20 1/2" x 33 3/4" x 2"

042020

Stackable





LEAF

Design by FRANK LIGTHART, 2006

An iconic and award-winning collection with an organic, ergonomic design. Optional cotton overlay for luxurious lounging.



2x Beach chair XS

Typology

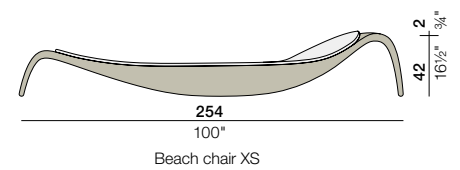

RRP/UVF/PVPR

BEACH CHAIR XS
Sonnenliege XS
Tumbona XS

15 kg
33 lbs



018
004

cm inch

Materials

Fibers



018
java

004
seagrass

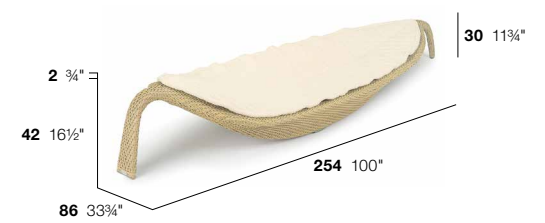

035018004

CUSHION
Kissen
Toalla

80 x 210 cm
31 1/2" x 82 3/4"

99035018000

56035018000

EN CUSHION Special padded towel in the design of a "leaf". Padded towel only available in this design. Material: Cotton.
DE KISSEN Spezialauflage im Blatt-Design. Die Auflage ist ausschließlich in dieser Form und Farbe erhältlich. Material: Baumwolle.
ES COJINES Toalla especial con forma de hoja. La toalla sólo está disponible en este diseño. Material: algodón.





NEWPORT

Design by HENRIK PEDERSEN, 2019

A comfortable and versatile collection made of aluminum and sling material for seat and back. It is lightweight, durable and thought-through to the smallest detail.



2x Armchair, anthracite
Cushion: COOL dark gray
Dining table 90 x 73,3 35½" x 35½", HPL black

CONTRACT

CONTRACT

Typology

cm inch

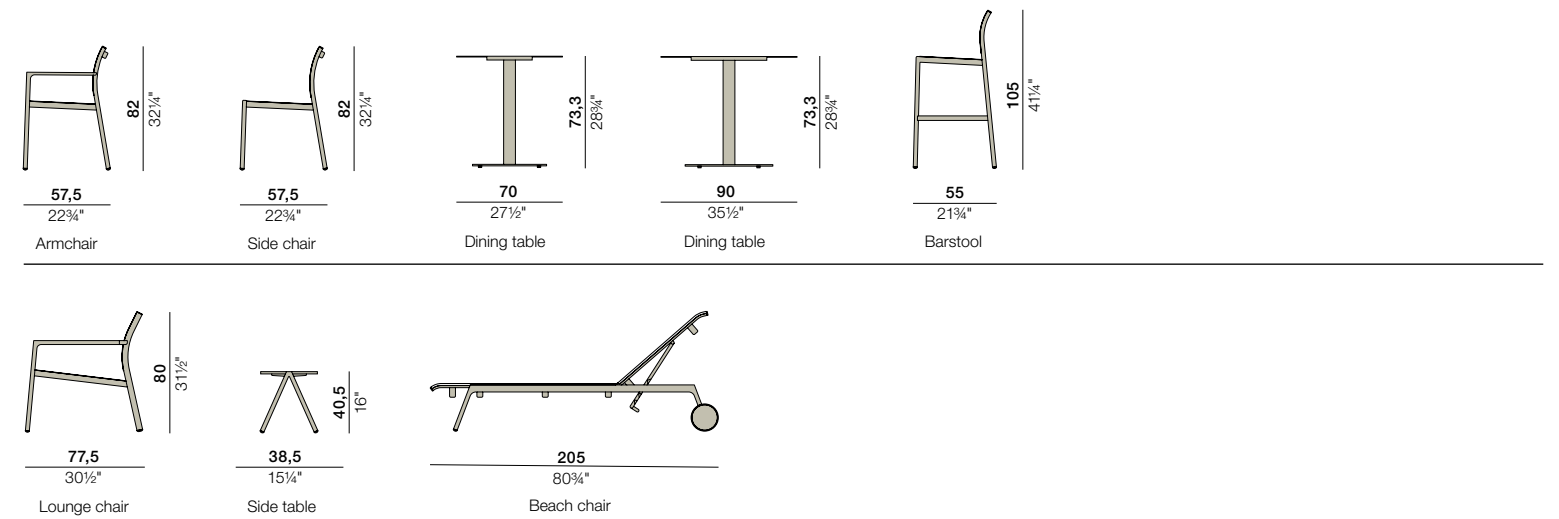

NEWPORT

Design by HENRIK PEDERSEN, 2019



Armchair anthracite
Armchair pearl gray
Side chair anthracite

RRP/UVF/PVPR

ARMCHAIR
Armlehnstuhl
Silla con brazos

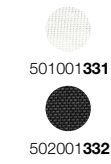

5 kg
11 lbs

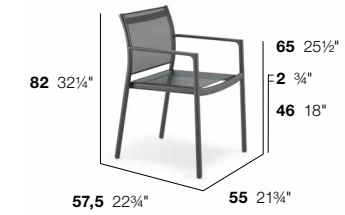

502001332

CUSHION
Kissen
Cojín

SEAT CUSHION + BACK CUSHION
Sitzkissen + Rückenkissen
Cojín de asiento + Cojín de respaldo

48 x 48 x 2 cm
19" x 19" x 3/4"

48 x 48 cm x 2 cm + 36,5 x 48 cm x 2 cm
19" x 19" x 3/4" + 14 1/4" x 19" x 3/4"

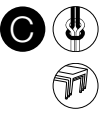

95500002

95500001

SIDE CHAIR
Esstisch
Silla de comedor

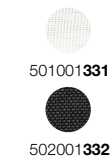

4,1 kg
9 lbs

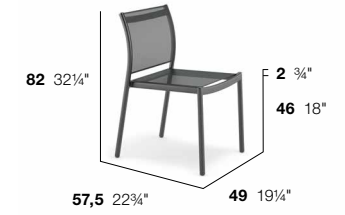

50200332

CUSHION
Kissen
Cojín

SEAT CUSHION + BACK CUSHION
Sitzkissen + Rückenkissen
Cojín de asiento + Cojín de respaldo

48 x 48 x 2 cm
19" x 19" x 3/4"

48 x 48 cm x 2 cm + 36,5 x 48 cm x 2 cm
19" x 19" x 3/4" + 14 1/4" x 19" x 3/4"

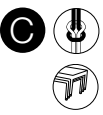

95500002

95500001

DINING TABLE, HPL
Esstisch, HPL
Mesa comedor, HPL

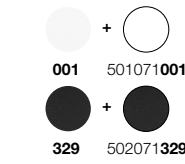

70 x 70 cm
18,3 kg
27 1/2" x 27 1/2"
41 lbs

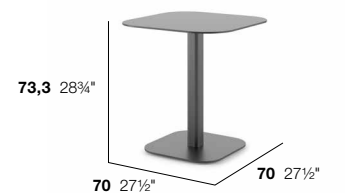

502071329

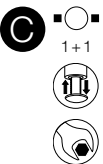

DINING TABLE, POWDER COATED METAL
Esstisch, pulverbeschichtetes Metall
Mesa comedor, metal con acabado de pintura en polvo

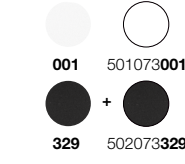

70 x 70 cm
20,4 kg
27 1/2" x 27 1/2"
41 lbs

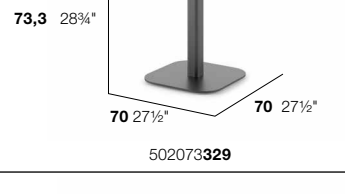

502073329



DINING TABLE, HPL
Esstisch, HPL
Mesa comedor, HPL

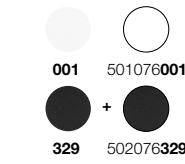

90 x 90 cm
30,2 kg
35 1/2" x 35 1/2"
67 lbs

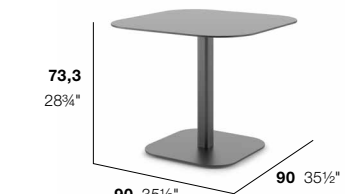

502076329



DINING TABLE, POWDER COATED METAL
Esstisch, pulverbeschichtetes Metall
Mesa comedor, metal con acabado de pintura en polvo

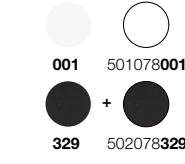

90 x 90 cm
36,2 kg
35 1/2" x 35 1/2"
80 lbs

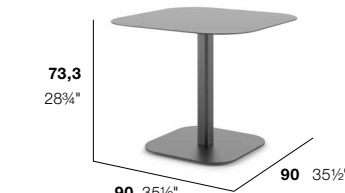

502078329



Materials

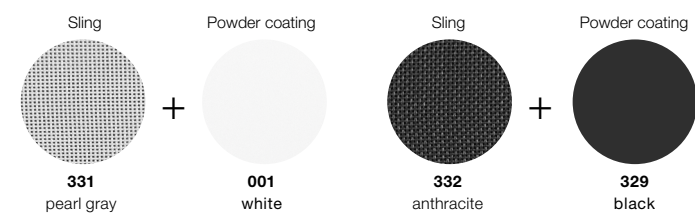

Tabletops HPL



Tabletops powder coated metal

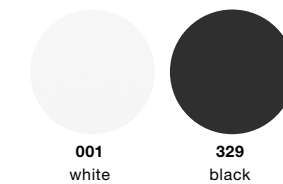

RRP/UVP/PVPR

LOUNGE CHAIR

Sessel
Sillón bajo

501005331

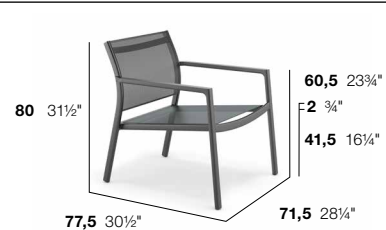

502005332

7,2 kg
16 lbs

502005332

CUSHION

Kissen
Cojín66,5 x 62,5 x 2 cm
26 1/4" x 24 1/2" x 3/4"

SEAT CUSHION + BACK CUSHION

Sitzkissen + Rückenkissen
Cojín de asiento + Cojín de respaldo66,5 x 62,5 cm x 2 cm + 44 x 62,5 cm x 2 cm
26 1/4" x 24 1/2" x 3/4" + 17 1/4" x 24 1/2" x 3/4"

SIDE TABLE

Beistelltisch
Mesa auxiliar

501034001



502034329

37,5 x 37,5 cm
3,4 kg
15 1/4" x 16 3/4"
8 lbs

502034329

BEACH CHAIR

Sonnenliege
Tumbona

501019331



502019332

16,3 kg
36 lbs

502019332

CUSHION

Kissen
Cojín204 x 66,5 x 2 cm
80 1/4" x 26 1/4" x 3/4"

BARSTOOL

Barhocker
Taburete de bar

501028331

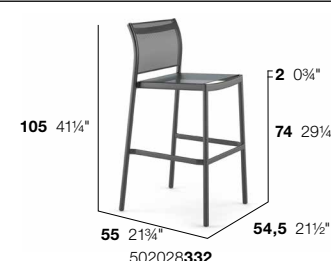

502028332

5,2 kg
12 lbs

502028332

CUSHION

Kissen
Cojín45,5 x 43 x 2 cm
18" x 17" x 3/4"

SEAT CUSHION + BACK CUSHION

Sitzkissen + Rückenkissen
Cojín de asiento + Cojín de respaldo45,5 x 43 cm x 2 cm + 30 x 43 cm x 2 cm
18" x 17" x 0 3/4" + 11 3/4" x 17" x 3/4"

EN MATERIAL

NEWPORTS's frames are made of powdercoated aluminum. Its seat and back consist of sling textile. The tabletops of dining tables are either made of "High Pressure Laminate" (HPL), a non-toxic material that is highly resistant to impact, mechanical stress, moisture and steam. Or are made of powdercoated aluminum, matching the color of the frame. Clean with a soft cloth and warm water.

DE MATERIAL

Der Rahmen von NEWPORT Möbeln besteht aus pulverbeschichtetem Aluminium, während die Sitzfläche und die Rückenlehne mit Sling-Material ausgestattet sind. Die Tischplatten der Esstische bestehen entweder aus HPL ("High Pressure Laminate"), einem ungiftigen Material, das sich durch hohe Stoßfestigkeit und extreme Widerstandskraft gegen mechanische Einwirkungen, Feuchtigkeit und Dampf auszeichnet. Oder sie wurden aus pulverbeschichtetem Aluminium gefertigt, passend zu der Farbe der Rahmen. Einfach mit einem weichen Tuch und warmem Wasser zu reinigen.

ES MATERIAL

El armazón de NEWPORT esta hecho en aluminio revestido con pintura en polvo. Su asiento y respaldo constan de un tejido mezcla de PVC y PES. Los tableros de las mesas de comedor están hechos de HPL ("Laminado de alta presión"), un material no tóxico que se caracteriza por su alta resistencia a los impactos y su extrema resistencia al estrés mecánico, la humedad y el vapor. O están hechos de aluminio con revestimiento de pintura en polvo, que coincide con el color de los marcos. Limpiar con un paño suave y agua tibia.



Beach chair, anthracite
Cushion: COOL dark gray

INFORMATION



WARRANTY

Collection	Residential 5 years Contract 5 years	Residential 5 years Contract 5 years	Residential 5 years Contract 3 years	Residential 2 years Contract 2 years*	Residential 2 years Contract 2 years	Residential 2 years Contract 2 years	Residential 2 years Contract 2 years	Residential 2 years Contract 2 years	Residential 2 years
	Aluminum	Woven frame	Teak Stainless steel	Belt Rope Sling*	Ceramic Glaze Glass + HPL Marble	LED lights	Fabric Cushion insert	Injection molded polypropylene	Gas spring
AHNDA	■	■			■		■		
AIIR			■					■	
BABYLON					■		■		
BABYLON PE						■		■	
BABYLON PLANTER								■	
BARCELONA	■	■			■		■		
BREA	■			■	■		■		
BRIXX							■		
CAIRO	■	■					■		
CIRQL	■	■					■		
DALA	■	■			■		■		
DALA PLANTER & LANTERN	■	■							
DEAN	■			■			■		
FEDRO	■	■					■		
HOLIDAY	■	■					■		
IZON	■				■				
KIDA	■	■		■			■		
LA MALLE	■	■	■	■					■
LEAF	■	■							
LOON			■			■		■	
LOU	■	■	■		■		■		
LOUNGE	■	■							■
MBARQ	■	■		■			■		
MBRACE	■	■	■		■		■		
MU	■	■		■	■		■		■
NESTREST	■	■		■			■		
NEWPORT	■			■			■		
ORBIT	■	■		■			■		
PANAMA	■	■		■	■		■		
PLAY		■						■	
PORCINI	■	■			■				
REAV	2 years	■							
RILLY	■	■		■			■		
SATELLITE	■				■				
SEALINE	■	■	■	■	■		■		
SEASHELL	■	■					■		
SEAX	2 years						■		
SWINGREST	■	■		■			■		
TANGO	■	■			■		■		■
THE OTHERS	■	■	■		■	■			
TIBBO	■	■	■	■			■		
VID							■		
WA	■		■		■				

EN 2021 WARRANTY TERMS

DEDON warrants to the original purchaser that our product is free from defective materials and workmanship under its intended reasonable use. The warranty starts from the date of sale to the end consumer. The warranty is non-transferrable, and is applicable to the original purchaser only. Proof of purchase will be required.

Any product believed to be of faulty materials or workmanship should be reported to DEDON as soon as reasonably possible. Following DEDON's assessment, any fault found and covered by this warranty will be rectified by the replacement or repair of the faulty part or product. DEDON will determine whether to replace or repair a faulty part or product. If deemed necessary to return a product for repair, DEDON will arrange for it to be returned to us via our choice of transit, and sent back to the original purchaser, free of charge. Circumstances may dictate the local repair is best course of action. No returns are accepted without prior written authorization from DEDON. The product must not have been misused or handled carelessly, nor have been damaged, neglected or used in abnormal conditions. The product must not have been modified, altered in any way, or repaired by anyone other than a member of DEDON staff or their appointed representatives.

The warranty will be valid only if proper maintenance and cleaning have been carried out in accordance with DEDON's aftercare instructions. This warranty does not apply to normal wear and tear caused by regular use or the passage of time. Damage such as dents, scratches or small chips in the paintwork arising from use

are not covered by this warranty. Marks and/or tears to fabrics or fibers that have happened during normal use are not covered by this warranty. Small cracks, which may appear in the end grain of teak when exposed to the elements, and any change of appearance due to usual weathering and/or changes in wood texture are considered natural for teak outdoor furniture and are not covered by this warranty. Wheels and foot caps are excluded from the general warranty, but are guaranteed for a period of one year from the date of delivery. The Sling / Strap / Rope warranty covers against tearing, discoloration, fading or change in shade of colors. Normal sagging is to be expected as a result of use and is not covered by this warranty. Due to the nature of the planks used to create RAW table tops, any splits, cracks in the end grain, hollow knots, twisting of timber over time, or degradation of the sapwood when outdoors are considered natural for thick-plank, teak outdoor furniture and are not covered by this warranty.

REPORTING OF COMPLAINTS

In order to look in to complaints/warranty issues, DEDON requires ALL of the following information provided in one single email: Photographs of the issue – general overview and close-ups of specific areas of damage and/or failure. Product code of item affected. The batch number and country of origin, which can be found on a small rectangular label located out of sight, usually on the underside of the item (for cushions, on the inside of the zipper; for covers, on the label). Date of purchase: Please send a copy of the invoice as proof of the purchase date. Location of furniture, e.g.

coastal / inland / swimming pool. Brief description of the damage and how the damage occurred.

Please always use a reference, i.e. a customer number in the title of the email, so that it is easy to track. Potential claims can be processed only if DEDON receives ALL necessary data. Once all of the above information has been received, we will review the case and advise in due course.

RETURNS POLICY

Written authorization must be obtained from DEDON prior to returning any physical products. Products returned without prior written authorization will be refused. DEDON accepts the return of a product only in cases of a manufacturer's defect. Products that were authorized to be sent to DEDON but show damage that is obviously due to improper use or storage of the product, damage resulting from normal wear and tear in the course or normal use of the product, or other damages that are not due to a manufacturer's defects will be returned to the sender at the sender's expense. DEDON reserves the right, in the event of rejection of a complaint, to pass on to the sender any freight costs incurred by DEDON as well as fees for processing and inspection of products that are subject to an unjustified complaint. Returned products are inspected by our Quality Control Department and replaced or repaired if the damage is a result of a manufacturer's defect. If it is determined not to be a manufacturer's defect, the customer, along with the Quality Control Department, will decide what further action to take.

DE GARANTIEBEDINGUNGEN 2021

DEDON garantiert dem ursprünglichen Käufer, dass die Materialien und die Verarbeitung des Produkts einwandfrei sind, soweit das Produkt bestimmungsgemäß und angemessen eingesetzt wird. Der Garantiezeitraum beginnt mit dem Verkauf des Produkts an den Endkunden.

Die Garantie ist nicht übertragbar und sie gilt nur für den ursprünglichen Käufer. Ein Kaufnachweis muss vorgelegt werden. Wenn Sie der Ansicht sind, dass die Materialien oder die Verarbeitung Ihres Produkts Grund zur Beanstandung geben, sollten Sie DEDON so schnell wie möglich darüber informieren. Sollte DEDON bei der Prüfung feststellen, dass ein Fehler vorliegt, der von dieser Garantie umfasst wird, wird das betreffende Teil oder Produkt ersetzt oder repariert. DEDON entscheidet nach eigenem Ermessen, ob ein fehlerhaftes Teil oder Produkt ersetzt oder repariert wird. Wenn entschieden wird, dass ein Produkt zu Reparaturzwecken zurückgesendet werden muss, so wird DEDON organisieren, dass es kostenfrei mit dem Transportmittel seiner Wahl zu DEDON und anschließend zurück zum Kunden transportiert wird. Unter Umständen kann eine Reparatur vor Ort die beste Lösung sein.

Wir nehmen keine Rücksendungen an, die nicht vorher schriftlich durch DEDON freigegeben wurden. Die Garantie gilt nicht für Schäden aufgrund von unsachgemäßer oder unachtsamer Behandlung, durch mutwillige Beschädigung oder im Fall einer Vernachlässigung oder Nutzung des Produkts unter ungewöhnlichen Umständen. Das Produkt darf nicht modifiziert oder auf irgendeine Weise verändert werden und Reparaturen dürfen nur von DEDON-Mitarbeitern oder ihren beauftragten Vertretern durchgeführt werden. Die Garantie gilt nur, wenn das Produkt entsprechend der Pflegehinweise von DEDON gewartet und gereinigt wurde. Die Garantie gilt nicht für normale Abnutzung durch die übliche Verwendung bzw. Alterserscheinungen.

Die Garantie erstreckt sich nicht auf Dellen, Kratzer und kleine Abblätterungen der Lackierung, die bei der Verwendung entstanden sind. Die Garantie gilt nicht für Flecken und / oder Risse im Stoff, die bei normaler Verwendung entstanden sind. Die Garantie gilt nicht für kleine Risse, die sich an den Enden von Teakholz-Teilen bilden können, wenn diese der Witterung ausgesetzt werden sowie für jegliche optische Veränderungen aufgrund normaler Witterung und / oder Veränderungen an der Holzstruktur, da diese bei Teakmöbeln für den Außenbereich als natürlich anzusehen sind. Rollen und Fußkappen sind von dieser Garantie ausgeschlossen. Für sie gilt jedoch ein Jahr Garantie ab dem Lieferdatum. Die Sling-/Gurt-/Seil-Garantie erstreckt sich auf Risse, Verfärbungen und das Verblässen bzw. die Veränderung von Farben, wobei ein normales Maß an Nachlassen des Materials bei Gebrauch zu erwarten und nicht durch die Garantie abgedeckt ist. Es liegt in der Natur des Holzes, das für NATURBELASSENE Tischplatten verwendet wird dass sich an den Enden des Holzes Risse oder Spalten bilden können, sich Hohlräume bilden oder das Holz sich im Laufe der Zeit verziehen sowie dass Splintholz sich beim Einsatz im Freien zersetzen kann. Diese Effekte gelten bei Möbeln aus dicken Teakholzbrettern für den Außenbereich als natürlich und werden nicht durch die Garantie abgedeckt.

REKLAMATION

Um Reklamationen/ Garantiefälle prüfen zu können, benötigt DEDON alle der folgenden Angaben gesammelt in einer E-Mail: Fotos des Schadens – Gesamtübersicht und Detailfotos der beschädigten bzw. fehlerhaften Bereiche. Den Produktcode des betroffenen Gegenstands, die Chargennummer und das Herkunftsland. Diese Angaben finden Sie auf dem kleinen rechteckigen Schild, das versteckt angebracht ist. Meist befindet es sich auf der Unterseite des Produkts (bei Polstern auf der Innenseite des Reißverschlusses, bei Bezügen auf dem Etikett).

Kaufdatum: Bitte schicken Sie uns eine Kopie der Rechnung als Beleg des Kaufdatums. Beschreibung des Standortes des Möbelstücks, z.B. an der Küste/ im Binnenland/ am Pool. Eine kurze Beschreibung des Schadens und wie er entstanden ist. Bitte geben Sie im Betreff der E-Mail stets einen Bezug an, wie z.B. eine Kundennummer. Das erleichtert uns die Zuordnung.

DEDON kann mögliche Ansprüche nur verarbeiten, wenn ALLE erforderlichen Angaben vorliegen. Sobald wir die oben angegebenen Informationen erhalten haben, werden wir den Fall prüfen und uns schnellstmöglich bei Ihnen melden.

RÜCKSENDUNGEN

Bevor Sie Artikel an DEDON zurücksenden, müssen Sie unsere schriftliche Zustimmung einholen. Wir nehmen keine Produkte an, wenn die Rücksendung nicht im Vorfeld schriftlich freigegeben wurde. DEDON akzeptiert die Rücksendung eines Produkts nur, wenn ein Herstellungsfehler vorliegt. Produkte, die mit DEDONs Zustimmung zurückgeschickt wurden, aber Schäden aufweisen, die offensichtlich entstanden sind, weil das Produkt unsachgemäß benutzt oder gelagert wurde, oder sonstige Schäden, bei denen es sich nicht um Herstellungsfehler handelt, werden auf Kosten des Versenders zurückgeschickt. Im Fall einer Zurückweisung der Reklamation behält DEDON sich das Recht vor, dem Versender alle entstandenen Transportkosten sowie die Kosten für die Bearbeitung und Prüfung des Produkts in Rechnung zu stellen, die aufgrund einer ungerechtfertigten Beschwerde entstanden sind. Unsere Abteilung für Qualitätsprüfung begutachtet alle zurückgesendeten Produkte. Im Fall eines Herstellungsfehlers werden die Produkte ersetzt oder repariert. Wenn es sich bei einer Beschädigung nicht um einen Herstellungsfehler handelt, entscheiden der Kunde und die Abteilung für Qualitätsprüfung gemeinsam über das weitere Vorgehen.

COPYRIGHT

EN INTELLECTUAL PROPERTY RIGHTS AND COPYRIGHT

The DEDON Collections have been exclusively designed by our company or developed for us by designers. All designs are registered. DEDON GmbH holds the copyrights for all products. All products carry the "DEDON" label. Our trademark is protected by law. Any infringement of our rights will be prosecuted.

Beyond that, the following premium materials have been utilized:

- Batyline® is a registered trademark of The Serge Ferrari SA, France
- Ferrari Stamoid® is a registered trademark of The Serge Ferrari Group, France
- Monolite Ipergres® is a registered trademark of Laboratorio Pesaro S.r.l., Italy
- Teflon® is a registered trademark of E. I. du Pont de Nemours and Company, USA
- WeatherMax® is a registered trademark of Safety Components Fabric Technologies, Inc., USA
- Tempotest® is a registered trademark of Para' S.P.A., Italy
- RESOPAL® is a registered trademark of Wilsonart Engineered Surfaces, USA
- Sunbrella® is a registered trademark of Glen Raven, Inc., USA

DE GEWERBLICHE SCHUTZRECHTE UND URHEBERRECHT

Alle DEDON-Kollektionen wurden in unserem Unternehmen designt oder wurden exklusiv von Designern für uns entwickelt. Die Designs sind als eingetragene Geschmacksmuster geschützt. Die urheberrechtlichen Nutzungsrechte für alle Produkte liegen bei der DEDON GmbH. Alle Erzeugnisse sind mit unserem Markenzeichen „DEDON“ gekennzeichnet. Unser Markenzeichen ist gesetzlich geschützt. Jeder Verstoß gegen unsere Rechte wird von uns verfolgt.

Folgende Premiummaterialien werden darüber hinaus eingesetzt:

- Batyline® ist eine eingetragene Marke der Firma The Serge Ferrari SA, Frankreich
- Ferrari Stamoid® ist eine eingetragene Marke der Firma The Serge Ferrari SA, Frankreich
- Monolite Ipergres® ist eine eingetragene Marke der Firma Laboratorio Pesaro S.r.l., Italien
- Teflon® ist eine eingetragene Marke der Firma E. I. du Pont de Nemours and Company, USA
- WeatherMax® ist eine eingetragene Marke der Firma Safety Components Fabric Technologies, Inc., USA
- Tempotest® ist eine eingetragene Marke der Firma Para S.P.A., Italien
- RESOPAL® ist eine eingetragene Marke der Firma Wilsonart Engineered Surfaces, USA
- Sunbrella® ist eine eingetragene Marke der Firma Glen Raven, Inc., USA

ES PROPIEDAD INDUSTRIAL Y DERECHOS DE AUTOR

Las colecciones DEDON han sido diseñadas por nuestra empresa o desarrolladas en exclusiva para nosotros por diseñadores. Los diseños gozan de la protección de diseños registrados. DEDON GmbH mantiene los derechos de autor sobre todos los productos. Los artículos y productos llevan la marca "DEDON", nuestra marca protegida por ley. Cualquier infracción contra nuestros derechos será perseguida judicialmente.

Se utilizan además los siguientes materiales premium:

- Batyline® es una marca registrada de The Serge Ferrari SA, Francia
- Ferrari Stamoid® es una marca registrada de The Serge Ferrari Group, Francia
- Monolite Ipergres® es una marca registrada de Laboratorio Pesaro S.r.l., Italia
- Teflon® es una marca registrada de E. I. du Pont de Nemours and Company, Estados Unidos
- WeatherMax® es una marca registrada de Safety Components Fabric Technologies, Inc., Estados Unidos
- Tempotest® es una marca registrada de Para' S.P.A., Italia
- RESOPAL® es una marca registrada de Wilsonart Engineered Surfaces, USA
- Sunbrella® es una marca registrada de Glen Raven, Inc., USA

© 2020 DEDON GmbH, Germany. The photographs featured in our catalogs and on our website are protected by United States and international copyright laws and may not be reproduced without the express written permission of DEDON GmbH or DEDON, Inc.

Photographs of products appearing to be suspended in space, in an unnatural recreational manner or over water may be simulations created by professionals. Do not attempt to recreate these applications on your own.



CAPTION

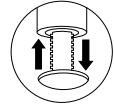

The furniture is fitted with sliding mechanisms for height adjustment.
Das Möbel ist mit höhenverstellbaren Gleitern ausgestattet.
El mueble lleva tapa-final regulable para ajustar la altura.



A piece for securely connecting sections is included.
Inklusive Verbindungsstück "Connector" zur sicheren Verbindung einzelner Module.
Está incluido un "conector" para conectar los modules de forma seguro.

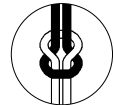

The cushions come equipped with a cushion holder to keep them from sliding.
Die Kissen werden mit einem Kissenhalter geliefert, damit sie nicht verrutschen können.
Los cojines vienen equipados con un soporte de fijación para evitar que se deslicen.

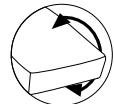

The seat cushion on this item may be flipped.
Das Sitzkissen dieses Möbels ist wendbar.
El cojín de este asiento es reversible.

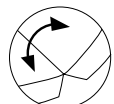

The foldable cushion comes with handles for easy transportation.
Das faltbare Sitzkissen wird mit zwei Schlaufen geliefert, um den Transport zu erleichtern.
El cojín plegable viene provisto de asas para facilitar su transporte.

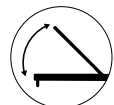

The backrest mechanism allows the stepless adjustment of your furniture thanks to a gas spring. Please review the instruction manual!
Der Mechanismus der Rückenlehne erlaubt aufgrund der Verwendung einer Gasdruckfeder das stufenlose Verstellen des Möbels. Bitte beachten Sie die mitgelieferte Gebrauchsanleitung!
El mecanismo del respaldo permite ajustar el mueble en progresión continua.
¡Por favor, tenga en cuenta las instrucciones de uso suministradas con el producto!

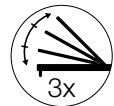

This item is available with a hook-catching mechanism. See icon for number of hooks.
Dieser Artikel ist mit Stufenverstellung erhältlich. Das Symbol zeigt jeweils die Anzahl der Stufen.
Este artículo dispone de un mecanismo de ajuste de altura. El icono muestra el número de ajustes.

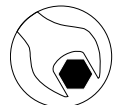
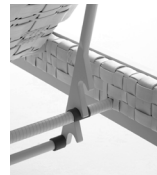

Some assembly required.
Montage erforderlich.
Requiere ensamblaje.



DEDON EcoCycle Fiber
This item is available with DEDON EcoCycle Fiber.
Dieses Produkt ist mit DEDON EcoCycle Faser erhältlich.
Este artículo está disponible con la fibra DEDON EcoCycle.



The furniture is fitted with wheels.
Das Möbel ist mit Rollen ausgestattet.
El mueble lleva ruedas.



This item is stackable.
Das Möbel ist stapelbar.
Este artículo es apilable.



Rotatable by 360°.
Um 360° drehbar.
Gira 360°.



This item offers a rocking feature.
Artikel mit Schaukelfunktion.
Este artículo se balancea.

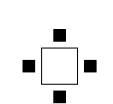

The recommended number of chairs is only for the displayed collection and does not necessarily apply to chairs from other collections.
Die empfohlene Anzahl gilt allein für die Stühle dieser Kollektion und kann nicht auf kollektionsfremde Stühle übertragen werden.
El número recomendado sólo se aplica a las sillas de esta colección y no se puede trasladar a sillas de otras colecciones.

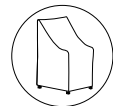

A protective cover is available for this item.
Für dieses Möbel ist eine schützende Husse erhältlich.
Existe la opción de una funda protectora para este mueble.

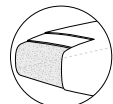

Dry+ cushion construction
Dry+ cushions are protected by a highly water-repellent interlayer up to 10,000 mm. This means that the material withstand a water column of 10 meters/32,81 ft.
Die Dry+ Kissen sind durch eine stark wasserabweisende innere Hülle mit einer Wassersäule von 10.000 mm geschützt.
Dies bedeutet, dass das Material einer Wassersäule von zehn Metern standhalten kann.
Los cojines Dry+ están protegidos con un revestimiento muy impermeable con una resistencia al agua de nada menos que 10.000 mm. Esto significa que el material soporta una columna de agua de 10 metros.

REAV



This item is available in two base configurations, for wind grade 3 (12-19 km/h) or wind grade 6 (39-49 km/h), the latter featuring additional steel weights.
The wind force is displayed within the icon.

Das Produkt ist mit zwei verschiedenen Ständervarianten erhältlich, die für Windstärke 3 (12-19 km/h) bzw. Windstärke 6 (39-49 km/h) geeignet sind; letztere Variante ist mit zusätzlichen Stahlgewichten ausgestattet. Die Windstärke ist mit einem Symbol angegeben.
Este producto está disponible en dos configuraciones posibles para la base: para una fuerza del viento 3 (12-19 km/h) o una fuerza del viento 6 (39-49 km/h). En el último caso, también cuenta con pesos de acero adicionales. Ver icono para encontrar el número de la fuerza del viento.



LIGHTING

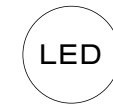

The product is fitted with an LED lighting module.
Das Produkt ist mit einem LED Modul ausgestattet.
Este producto viene equipado con un módulo de iluminación LED.



There are two ways of charging the LED module: by solar panel or by power adapter.
Zwei Optionen zum Aufladen des LED Moduls: Solarpanel oder Ladekabel.
Dos opciones para cargar el módulo LED: Panel solar o cable de carga.



The LED module is charged using a power adapter.
Das LED Modul wird mit einem Ladekabel aufgeladen.
El Módulo LED se carga solo a través del cable de carga.

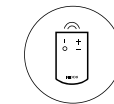

Remote Control: To switch on the light, use the remote control or the button on the bottom of the LED module.
Fernbedienung: Sie können entweder die Fernbedienung verwenden, um die Leuchten einzuschalten, oder die Taste an dem LED Modul.
Control remoto: Para encender las luces puede utilizar el control remoto o pulsar la tecla del módulo LED.

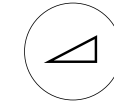

In addition to the on/off button, the remote control has a +/- function for adjusting the dimmer (8 steps).
Die Fernbedienung hat eine An- und eine Austaste sowie eine + und eine - Taste für die Dimm-Funktion (8 Stufen).
El control remoto tiene un botón de encendido y de apagado y un botón de + y - para la función de atenuación.

ROPE

EN ROPE

The traditional Italian maritime rope that DEDON uses for RILLY and SEALINE is a fresh interpretation of the brand's unique weaving heritage. Master colorist Giulio Ridolfo developed sophisticated yarn combinations for the rope, which is characterized by an appealing, textile touch.

Made of polypropylene yarns, with tenacity fillers for extra strength, the rope is weatherproof, non-absorbent and ideally suited for outdoor use. It offers excellent light fastness (grade 6), color fastness (against both chlorine and saltwater) and resistance to physical stress, UV radiation, mold and more. Stapled to the aluminum frame in the same way as DEDON Fiber, it is applied in short sections for easy repair. Wash at low temperature (30°C) with lukewarm water and a mild soap. To prevent dirt deposits, vacuum or lightly brush the rope regularly. Most dirt and stains can be cleaned if promptly treated.

DE SEIL

Das traditionelle maritime Seil aus Italien, das DEDON in den Kollektionen RILLY und SEALINE verwendet, ist eine erfrischende Neuinterpretation der einzigartigen Flechttradition der Marke. Der Farbdesigner Giulio Ridolfo hat die eleganten Garnkombinationen entwickelt, die für das Seil verwendet werden und ihm seine ansprechende textile Anmutung verleihen.

Das Seil besteht aus Polypropylen-Garnen mit Füllern für besonders hohe Zugfestigkeit. Es ist wetterfest, wasserabweisend und ideal für den Einsatz im Outdoor-Bereich geeignet – nicht zuletzt dank exzellenter Lichtechtheit (Grad 6), Farbechtheit (chlorwasser- und salzwasserbeständig) und seiner Widerstandsfähigkeit gegen physikalische Belastungen, UV-Strahlung, Schimmel und vieles mehr. Es wird, wie die DEDON-Faser, in kurzen Abschnitten auf den Aluminiumrahmen aufgebracht, was eventuelle Reparaturen vereinfacht. Mit lauwarmem Wasser (30°C) und einer milden Seife waschbar. Um Schmutzablagerungen zu verhindern, das Seil regelmäßig absaugen oder abbürsten. Die meisten Verschmutzungen oder Flecken lassen sich bei sofortiger Behandlung entfernen.

ES CUERDA

La cuerda náutica tradicional italiana que DEDON utiliza para RILLY y SEALINE es una nueva interpretación del inigualable patrimonio del tejido de la marca. El maestro colorista Giulio Ridolfo desarrolló sofisticadas combinaciones de hilo para la cuerda, la cual se caracteriza por su atractivo tacto, parecido al de un tejido.

Hecho con hilos de polipropileno y firmes rellenos para una mayor durabilidad, la cuerda es impermeable, no absorbente y totalmente apta para exteriores. Ofrece una gran resistencia a la luz (grado 6), colores perdurables (resistentes al cloro y al agua salada) y gran resistencia a la tensión física, a los rayos UVA, al moho y mucho más. Grapada al bastidor de aluminio de la misma forma que la fibra DEDON, la cuerda se aplica en fragmentos cortos para facilitar los trabajos de reparación. Limpiar a baja temperatura (30°C) con agua templada y jabón suave. Aspirar o cepillar suavemente la cuerda de vez en cuando para prevenir la acumulación de suciedad. La gran mayoría de suciedad y manchas pueden eliminarse si se tratan de inmediato.

FIBER

EN DEDON FIBER

Researched, developed, manufactured and quality-tested at our production facilities in Northern Germany, DEDON Fiber (HDPE) is unrivaled for its durability, weather-fastness and luxuriousness of color, texture and touch. Strong enough to withstand the harshest conditions yet supple enough to be woven into artful patterns by our master weavers, it has revolutionized outdoor furniture.

Because DEDON produces its fiber entirely in-house, we are able to work with our world-renowned designers to develop unique colors, textures and profiles. Our specialists monitor every new fiber we create, checking for resistance to UV-rays, salt water, pool water and extreme temperatures. The final product is non-toxic, non-polluting and fully recyclable. It is maintenance-free, easy to clean and recommended for indoor and outdoor use.

DEDON EcoCycle Fiber - Made with the help of nature 

Derived 90% from renewable plant-based resources, DEDON EcoCycle Fiber is an ecologically-conscious alternative alternative to conventional, fossil-fuel-based products. It offers the same luxurious look and feel as standard DEDON Fiber, as well as the same unrivaled strength and weatherability.

With EcoCycle Fiber, DEDON proves the viability of an innovative sourcing procedure for renewable raw material. DEDON EcoCycle Fiber is made with polyethylene derived from sugarcane ethanol. Extruded at DEDON's own state-of-the-art production facilities in Northern Germany, EcoCycle Fiber meets the same exceptional standards of quality—and is protected by the same warranty—as DEDON Fiber. And like DEDON Fiber, it is fully recyclable through existing systems at the end of its product lifecycle.

DE DIE DEDON-FASER

Die DEDON-Faser (HDPE) wird in unseren hochmodernen Produktionsstätten in Norddeutschland erforscht, entwickelt, hergestellt und auf ihre Qualität getestet. Sie ist konkurrenzlos in ihrer Strapazierfähigkeit und Wetterfestigkeit und zeichnet sich durch luxuriöse Farben, feine Textur und besondere Haptik aus. Die Faser hat den Bereich Outdoor-Möbel revolutioniert, denn sie ist stark genug, den härtesten Bedingungen zu trotzen und gleichzeitig so biegsam, dass unsere Flechtkünstler kunstvolle Muster aus ihr fertigen können.

Dadurch, dass wir bei DEDON unsere Fasern komplett im eigenen Hause fertigen lassen, können wir gemeinsam mit unseren Designern von Weltruf Fasern mit einzigartigen Farben, Oberflächen und Faserprofilen entwickeln. Jede neu entwickelte Faser wird von unseren Experten auf ihre Beständigkeit gegen UV-Strahlung, Salz- und Chlorwasser sowie extreme Temperaturen geprüft. Das fertige Produkt ist schadstofffrei, umweltfreundlich sowie voll recycelbar, wartungsfrei, leicht zu reinigen und für den Einsatz im Innen- und Außenbereich geeignet.

DEDON EcoCycle Faser - Hergestellt mit Hilfe von Mutter Natur 

DEDON EcoCycle Faser wird zu 90% aus erneuerbaren pflanzlichen Ressourcen gewonnen und ist eine umweltbewusste Alternative zu konventionellen, auf fossilen Brennstoffen basierenden Produkten. Sie bietet die gleiche luxuriöse Optik und Haptik wie die original DEDON Faser sowie die gleiche konkurrenzlose Festigkeit und Witterungsbeständigkeit.

Mit EcoCycle Faser beweist DEDON die Machbarkeit eines innovativen Beschaffungsverfahrens für nachwachsende Rohstoffe. DEDON EcoCycle Faser wird aus Polyethylen hergestellt, das aus Zuckerrohr-Ethanol gewonnen wird. Extrudiert in DEDON's eigenen hochmodernen Produktionsanlagen in Norddeutschland, erfüllt EcoCycle Faser die gleichen außergewöhnlichen Qualitätsstandards - und ist durch die gleiche Garantie geschützt wie die original DEDON Faser. Und wie diese ist sie am Ende ihres Produktlebenszyklus über bestehende Systeme vollständig recycelbar.

ES FIBRA DEDON

Investigada, desarrollada, fabricada y de calidad probada en nuestras instalaciones de producción del norte de Alemania. La fibra DEDON (HDPE) es inigualable por su durabilidad y resistencia a las condiciones climáticas, así como por el lujo de colores, texturas y tactos. Lo suficientemente fuerte para resistir a las condiciones más duras, pero lo bastante flexible para ser trenzada por nuestros maestros tejedores, que crean artísticos patrones, esta fibra ha revolucionado el mobiliario de exterior.

DEDON fabrica sus fibras en sus instalaciones, por lo que somos capaces de trabajar con nuestros diseñadores de renombre internacional para desarrollar colores, texturas y perfiles únicos. Nuestros especialistas supervisan cada nueva fibra que creamos, comprobando su resistencia a los rayos UV, al agua salobre, al agua de piscina y a las temperaturas extremas. El producto final no contiene sustancias nocivas, no es contaminante y es totalmente reciclable. No requiere mantenimiento, es fácil de limpiar y es recomendable para utilizar tanto en exteriores como en interiores.

Fibra DEDON EcoCycle - Hecha con la ayuda de la naturaleza 

Derivada en un 90% de recursos vegetales renovables, la Fibra DEDON EcoCycle es una alternativa ecológica a los productos convencionales basados en combustibles fósiles. Ofrece el mismo aspecto y sensación de lujo que la fibra estándar de DEDON, así como la misma fuerza y resistencia inigualable a la intemperie.

Con la fibra EcoCycle, DEDON demuestra la viabilidad de un innovador procedimiento de abastecimiento de materia prima renovable. La fibra DEDON EcoCycle está hecha con polietileno derivado del etanol de la caña de azúcar. Extruida en las propias instalaciones de producción de última generación de DEDON en el norte de Alemania, la fibra EcoCycle cumple con los mismos estándares excepcionales de calidad y está protegida por la misma garantía que la fibra de DEDON. Y como ellos, es totalmente reciclable a través de los sistemas existentes al final del ciclo de vida del producto.

TABLETOPS

EN THE FINISHING TOUCHES FOR YOUR TABLE

From glass to teak, aluminum to HPL, DEDON offers a wide range of tabletop materials. These innovative solutions not only integrate with the design concepts of the various collections but also meet the top-quality standards DEDON insists upon for all of its outdoor furniture.

- **SINGLE-LAYER TEMPERED GLASS**
Offers increased resistance to temperature changes as well as excellent resistance to bending, impact and shock. To clean a glass tabletop, use a soft cloth, warm water and a gentle cleanser if needed.
- **HIGH PRESSURE LAMINATE (HPL)**
A non-toxic material that is highly resistant to impact, mechanical stress, moisture and steam. To clean an HPL tabletop, use a soft cloth, warm water and a gentle cleanser if needed.
- **POWDER COATED METAL**
The metal sheets are covered with a highly resistant powder coating, giving the tabletop unbeatable durability and outdoor performance. Clean with a soft cloth and warm water.

DE DER LETZTE SCHLIFF FÜR IHREN TISCH

Ob Glas, Teak, Aluminium oder HPL: DEDON bietet eine große Palette verschiedener Materialien für Tischplatten. Diese innovativen Werkstoffe passen nicht nur genau zum jeweiligen Designkonzept der verschiedenen Kollektionen, sie erfüllen auch die höchsten Qualitätsansprüche, die DEDON bei der Verwendung für Gartenmöbel fordert.

- **GLAS**
Das Einscheibensicherheitsglas verfügt über eine verbesserte Temperaturwechselbeständigkeit und weist eine sehr gute Biege-, Schlag- und Stoßfestigkeit auf. Zur Reinigung der Tischplatte eignen sich ein weiches Tuch, warmes Wasser und bei Bedarf ein sanftes Reinigungsmittel.
- **HIGH-PRESSURE-LAMINATE (HPL)**
HPL ist ein ungiftiges Material, das sich durch hohe Stoßfestigkeit und extreme Widerstandskraft gegen mechanische Einwirkungen, Feuchtigkeit und Dampf auszeichnet. Zur Reinigung der Tischplatte eignen sich ein weiches Tuch, warmes Wasser und bei Bedarf ein sanftes Reinigungsmittel.
- **PULVERBESCHICHTETES METALL**
Die Metallplatten sind mit einer hochresistenten Pulverbeschichtung versehen. Diese Tischplatten zeichnen sich durch besondere Haltbarkeit und Wetterfestigkeit aus. Einfach mit einem weichen Tuch und warmem Wasser zu reinigen.

ES LOS ÚLTIMOS RETOQUES PARA SU MESA

Si cristal, teca, aluminio o madera contrachapada termoformada al vapor (HPL), DEDON ofrece una amplia gama de materiales para tablas de mesa. Estos materiales innovadores no solamente se integran bien en los conceptos de las más variadas colecciones, sino que además cumplen con los más altos requisitos de calidad de DEDON para su utilización en mobiliario de exterior.

- **CRISTAL**
El cristal de seguridad monocapa aumenta la resistencia a los cambios de temperatura y ofrece una excelente resistencia a la flexión, impacto y los golpes. Para limpiar los tableros de las mesas, utilice un paño suave y agua caliente y, si es necesario, un limpiador suave.
- **HPL**
Laminado de alta presión (HPL) es un material no tóxico altamente resistente al impacto, estrés mecánico, humedad y vapor. Para limpiar los tableros de las mesas, utilice un paño suave y agua caliente y, si es necesario, un limpiador suave.
- **METAL RECUBIERTO EN POLVO**
Las láminas de metal están recubiertas de una capa en polvo altamente resistente que ofrece a la mesa un rendimiento y una durabilidad incomparables en espacios exteriores. Limpiar con un paño suave y agua tibia.

- **NATURAL-FINISH TEAK**
Consisting of beautiful premium teak sourced from sustainable plantations, the tabletop is rich with natural tannin oils, offering great durability in extreme weather conditions. Wash with natural soap dissolved in warm water.
- **MINERAL COMPOSITE**
These innovative, long-lasting mineral-composite tabletops are waterproof, extremely hygienic and highly resistant to frost, UV-rays and abrasion. Clean with soft cloth and warm water.
- **CERAMIC**
The tabletop is made of Monolite Ipergres®, a frost-proof ceramic that is non-absorbing and highly resistant to impacts, scratches and abrasion. Clean with a soft cloth and warm water.

Watch out: Dark tabletops may become very hot when exposed to strong sunlight.

- **NATURBELASSENES TEAK**
Tischplatten aus Premiumteak von nachhaltig bewirtschafteten Plantagen, das reich an natürlichen Tanninen ist, verfügen auch unter extremen Wetterbedingungen über eine äußerst lange Lebensdauer. Reinigen Sie das Holz mit lauwarmem Wasser unter Hinzugabe von materialschonender Naturseife.
- **MINERAL KOMPOSITWERKSTOFF**
Die innovativen, haltbaren Tischplatten aus Mineralkompositwerkstoff sind wasserfest, extrem hygienisch und hochgradig frost-, UV- und abriebresistent. Einfach mit einem weichen Tuch und warmem Wasser zu reinigen.
- **KERAMIK**
Die Tischplatte besteht aus Monolite Ipergres®, einem frostsicheren, nicht-absorbierendem Keramikmaterial, das extrem resistent gegen Stöße, Kratzer und Abrieb ist. Einfach mit einem weichen Tuch und warmem Wasser zu reinigen.

Achtung: Dunkle Tischplatten können sich im Sonnenlicht sehr stark aufheizen.

- **TECA NATURAL**
Esta maravillosa madera teca de calidad superior y de lento crecimiento, obtenida de plantaciones sostenibles y rica en aceites naturales de taninos, ofrece una gran durabilidad en condiciones meteorológicas extremas. Lavar con agua templada y jabón natural en copos bien disuelto.
- **COMPUESTO MINERAL**
Estos innovadores y duraderos tableros elaborados con compuesto mineral son impermeables, extremadamente higiénicos y resistentes a las heladas, los rayos UVA y la abrasión. Limpiar con un paño suave y agua tibia.
- **CERÁMICA**
El tablero está elaborado con Monolite Ipergres®, una cerámica a prueba de heladas, no absorbente y altamente resistente a los golpes, rasguños y rozaduras. Limpiar con un paño suave y agua tibia.

Atención: Los tableros oscuros pueden calentarse mucho al estar expuestos luz solar intensa.



TEAK

EN THE BEAUTY OF TEAK

Teak is one of the world's most valuable timber resources. Furniture made from beautiful premium teak, sourced from sustainable plantations, is rich in natural tannins and is able to withstand even extreme weather conditions over an exceptionally long lifetime. The wood is resistant to rain, strong sunlight, freezing conditions and fluctuating temperatures. These qualities make it particularly well-suited to long-term outdoor use.

Made exclusively from premium teak, DEDON teak furniture requires no special maintenance besides other than periodic cleaning. If allowed to age naturally outdoors, it will eventually turn to a soft, silver-gray as surface pigments fade. As this is a natural process, the silver-gray color may appear irregularly, especially at first.

To retain the wood's original, golden hue, use DEDON teak oil at least twice a year. To clean it, use a DEDON cleaning agent once or twice a year. To remove any rough grain and restore the wood to its smooth finish, lightly sand the surface from time to time.

DE DIE SCHÖNHEIT VON TEAK

Teakholz gehört zu den wertvollsten Nutzholzern der Welt. Möbel aus diesem schönen Premiumteak aus nachhaltig bewirtschafteten Plantagen, das reich an natürlichen Tanninen ist, verfügen auch unter extremen Wetterbedingungen über eine äußerst lange Lebensdauer. Das Holz widersteht Nässe, extremer Sonneneinstrahlung und Kälte sowie Temperaturschwankungen. Es ist daher zum Dauereinsatz im Freien besonders geeignet.

DEDON-Teakmöbel bedürfen neben einer gelegentlichen Reinigung keiner besonderen Pflege. Setzt man Teak auf natürliche Weise dem Wetter aus, verändert sich seine goldene Farbe und wird zu einem weichen Silbergrau. Da es sich hierbei um einen natürlichen Alterungsprozess handelt, kann das Silbergrau besonders anfangs noch etwas ungleichmäßig erscheinen.

Wünschen Sie einen Erhalt des goldenen Farbtons, streichen Sie mindestens zweimal jährlich das Teak mit DEDON-Teaköl ein. Reinigen Sie das Holz ein- oder zweimal im Jahr mit DEDON-Reinigungsmittel. Teakmöbel können auch von Zeit zu Zeit leicht abgeschliffen werden, um raue Maserungen zu entfernen und die Oberfläche wieder zu glätten.

ES LA BELLEZA DE LA TECA

La madera de teca es una de las maderas útiles más valiosas del mundo. El mobiliario compuesto por esta bonita teca premium, proviene de plantaciones sostenibles, rica en tanino natural, tiene una vida útil extraordinariamente larga incluso en condiciones meteorológicas extremas. La madera es resistente a la humedad, a la radiación solar extrema, al frío y a cambios de temperatura. Por eso, es idónea para el uso permanente al aire libre.

Además de una limpieza periódica, los muebles de teca DEDON no requieren un mantenimiento especial. Si se somete a la teca a condiciones meteorológicas naturales, su color dorado se volyverá en un gris plateado uniforme. Puesto que se trata de un proceso natural, el gris plateado podría aparecer de forma irregular, especialmente al principio.

Si se desea conservar su color dorado original, unte la teca al menos dos veces al año con aceite para teca DEDON. Limpie la madera una o dos veces al año con productos de limpieza DEDON. Los muebles de teca se pueden lijar de vez en cuando para eliminar vetas ásperas y restaurar el acabado liso de la superficie.

Allow your teak furniture with cushions to dry before using covers. To prevent mold and stains, DEDON recommends not to use covers for tables with teak tabletops.

Cushions that are in contact with new teak can occasionally show signs of teak staining. This is caused when the natural pigments and oils within the new teak bleed out over time, leaving a red-brown stain on the cushion fabric. To remove the teak stains, wash the cushion covers at a lukewarm temperature (30°C) with a mild soap. Teak bleeding may leave stains on the ground around the furniture as well. Any damage caused by teak bleeding is not covered by DEDON warranty.

Stellen Sie sicher, dass die Teakmöbel mit Kissen vollständig trocken sind, bevor Sie sie abdecken. Wir raten Ihnen die Tische mit Teakoberfläche nicht mit Hussen abzudecken, um Schimmelbildung auf der Tischplatte vorzubeugen.

Kissen, die mit neuem Teakholz in Kontakt kommen, können gelegentlich Anzeichen von Flecken aufweisen. Dies wird verursacht, wenn die Pigmente und Öle im neuen Teakholz mit der Zeit ausbluten und einen rotbraunen Fleck auf dem Kissenstoff hinterlassen. Um diese Teakholz-Flecken zu entfernen, waschen Sie die Kissenbezüge bei niedriger Temperatur (30°C) mit lauwarmem Wasser und einer milden Seife. Ausblutendes Teakholz kann ebenfalls Flecken auf dem Boden rund um die Möbel hinterlassen. Schäden, die durch Teakholzbluten entstehen, sind nicht durch die DEDON Garantie abgedeckt.

Deje que sus muebles de teca con cojines se sequen antes de usar las fundas. DEDON no recomienda el uso de fundas en mesas con tablero de teca para evitar el moho y las manchas.

Los cojines que están en contacto con la teca nueva pueden mostrar ocasionalmente signos de manchas de teca. Esto se produce cuando los pigmentos y aceites de la teca nueva se desangran con el tiempo, dejando una mancha marrón rojiza en la tela del cojín. Para limpiar estas manchas de teca de los cojines, lave las fundas de los cojines a baja temperatura (30°C) con agua tibia y un jabón suave. El sangrado de la teca también puede dejar manchas en el suelo alrededor de los muebles. Los daños causados por el sangrado de la teca no están cubiertos por la garantía de DEDON.



NATURAL-FINISH TEAK
Naturbelassenes Teakholz
Teca natural



WEATHERED TEAK
Verwittertes Teak
Teca envejecida

MAINTENANCE PRODUCTS

TEAK CLEANER
Teak-Reiniger
Limpiador para teca



6600000759

TEAK OIL
Teak-Öl
Aceite de teca



6640000055

COVER

EN DEDON COVERS – HANDLING AND CARE

DEDON furniture covers are made of Weathermax®, a heavy-duty, 100%-solution-dyed polyester fabric. Weathermax® is water-resistant and UV-resistant, with outstanding breathability and durability. Because of their superior breathability, DEDON covers minimize dampness, heat build-up and condensation, helping to prevent mold and mildew from forming on your furniture.

Tailored to fit perfectly over their corresponding products, DEDON covers feature zippers for easy draping as well as elastic straps and loops (product-specific) for securing them in windy conditions. Clean covers with warm water and a gentle upholstery cleaner. Take care to prevent puddles of water from forming on the cover's surface. Before storing, allow them to dry by hanging them using the featured strap (not part of all covers). Do not bleach or iron.

All cushions should be dry before applying DEDON covers. For longer periods, e.g. during wintertime, we recommend storing your cushions in a dry place indoors.

DE DEDON HUSSEN – HANDHABUNG UND PFLEGE

Die DEDON-Hussen bestehen aus dem Stoff Weathermax®, einem zu 100% in Masse gefärbten, extrem strapazierfähigen Polyester. Weathermax® ist sowohl resistent gegen UV-Strahlung als auch wasserabweisend, luftdurchlässig und langlebig. Die Luftdurchlässigkeit des Materials ist zur Reduzierung von Feuchtigkeit, Wärmeentwicklung und Kondensation sehr wichtig. Das wiederum beugt Schimmelbildung auf oder in den Möbeln vor.

Die Hussen wurden den Maßen Ihres Möbelstückes genau angepasst. Sie sind—je nach Produkt—mit Reißverschlüssen, elastischen Nähten und Schlaufen ausgestattet, damit sie einfach über dem Möbel platziert und bei Wind festgezurt werden können. Achten Sie darauf, dass sich auf der Hussenoberfläche keine Wasserablagerungen bilden. Reinigen Sie die Hussen mit einem weichen Tuch und warmem Wasser. Wenn nötig, verwenden Sie einen schonenden Polsterreiniger. Nicht bleichen, nicht bügeln.

Stellen Sie sicher, dass sowohl die Möbel als auch die Kissen vollständig trocken sind, bevor Sie sie abdecken. Für die dauerhafte Lagerung (beispielsweise während der Wintermonate) raten wir Ihnen die Kissen im Innenraum aufzubewahren.

ES FUNDAS DEDON – USO Y MANTENIMIENTOR

Las fundas DEDON están fabricadas con Weathermax®, un tejido 100% de poliéster teñido de alta resistencia. Weathermax® es un material hidrófugo y resistente a los rayos UV, con una excelente transpiración y durabilidad. Gracias a su gran transpiración, las fundas DEDON reducen la formación de humedad, la acumulación de calor y la condensación, ayudando a prevenir la formación de moho en los muebles.

Adaptadas para encajar perfectamente en los productos correspondientes, las fundas DEDON incluyen cremallera, cintas elásticas y cierres (específicos para cada producto) para asegurarlas cuando hace viento. Asegúrese de que no se formen acumulaciones de agua en la superficie de la funda. Lavar las fundas con agua tibia y un limpiador suave para tapicería. Antes de guardarlas, colgarlas para que se sequen usando las cintas (no incluidas en todas las fundas). No usar lejía ni planchar.

Los cojines deben estar secos antes de poner las fundas DEDON. Para periodos largos, como por ejemplo durante el invierno, recomendamos guardar los cojines en un lugar interior seco.





DECO CUSHIONS

DECO CUSHIONS
Dekokissen
Cojines de decoración

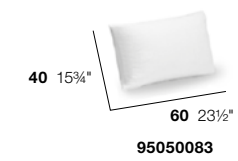
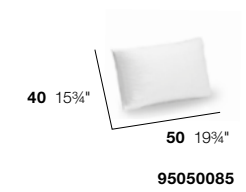
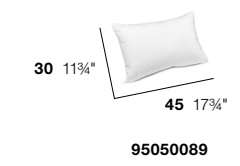
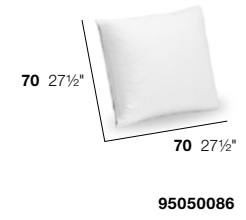
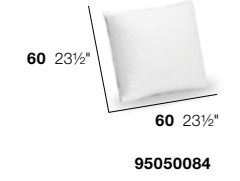
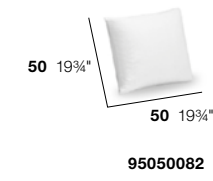
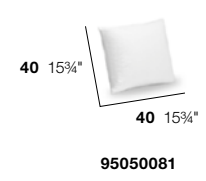

DEDON fabrics per meter
DEDON Stoffe Meterware
DEDON tela a metros

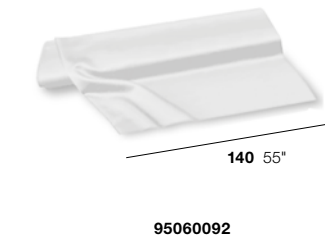

CUSHIONS & FABRICS

EN CUSHIONS YOU CAN LEAVE OUTDOORS

DEDON relies on some of the world's most advanced textile technologies to create cushions you can leave outside. Our high-quality acrylic materials are UV-resistant and specially treated to be splash-resistant, all with no loss of comfort. The foam cores, created exclusively for DEDON, and synthetic fiber padding are surrounded by a water-repellent, breathable, spun-bonded wrap. After a rain shower, allow your cushions to dry so as to protect them from mold stains. We recommend storing your cushions for the winter or when not in use for long periods, and using covers to keep them at their best. Before storing, make sure they are completely dry. Our materials meet the highest standards of quality for outdoor usage. All fabrics are quick-drying and easy to maintain.

DRY+ CUSHION CONSTRUCTION

Dry+ cushions offer enhanced rain protection. Cushion cores are wrapped in a breathable polyester interlayer with a very high water-repellent rating of 10,000 mm. All cushion cover fabrics are specially treated to be stain- and water-repellent. Available for any collections accompanied by this icon:



DE KISSEN, DIE DRAUSSEN BLEIBEN KÖNNEN

DEDON setzt die weltweit modernsten Textiltechnik-Verfahren ein, damit Ihre Kissen auch mal draußen bleiben können. Dank einer speziellen Behandlung sind unsere hochwertigen Acrylmateriale spritzwassergeschützt, ohne sich deshalb weniger komfortabel anzufühlen. Darüber hinaus sind sie beständig gegen UV-Strahlen. Der speziell für DEDON hergestellte Schaumstoffkern und die Kunstfaserpolsterung werden durch einen wasserabweisenden und gleichzeitig atmungsaktiven Spinnvliesstoff umhüllt. Lassen Sie Ihre Kissen nach einem Regenschauer trocknen, um sie vor Stockflecken zu schützen. Verstauben Sie Ihre Kissen im Winter oder wenn Sie sie über längere Zeit nicht nutzen. Am schönsten bleiben die Kissen, wenn Sie sie mit DEDON-Hussen abdecken. Stellen Sie vor dem Verstauben und Abdecken sicher, dass die Kissen vollständig trocken sind. Unsere Materialien entsprechen den höchsten Qualitätsstandards für die Nutzung im Freien. Sämtliche Materialien sind schnelltrocknend und pflegeleicht.

DRY+ KISSENKONSTRUKTION

Dry+ Kissen bieten einen erweiterten Wetterschutz. Die Kissen sind durch eine stark wasserabweisende innere Hülle mit einer Wassersäule von 10.000 mm geschützt. Der Stoff ist so behandelt, dass er schmutz- und wasserabweisend ist. Die Dry+ Kissenkonstruktion ist erhältlich für alle Kissen, die mit folgendem Icon gekennzeichnet sind:



ES COJINES QUE PUEDES DEJAR EN EL EXTERIOR

DEDON se basa de las tecnologías textiles más avanzadas del mundo para crear cojines que pueda dejar en el exterior. Nuestros materiales acrílicos de alta calidad están especialmente recubiertos para ser resistentes a las salpicaduras de agua sin que ello suponga una pérdida del confort. Además, son resistentes a los rayos UV. Los núcleos de espuma, creados exclusivamente para DEDON, y el relleno de fibra sintética están cubiertos por una envoltura impermeable, transpirable y no tejida. Después de un aguacero, permita que sus cojines se sequen con el fin de protegerlos de las manchas de moho. Le recomendamos que guarde sus cojines durante el invierno o cuando no se usen durante largos períodos de tiempo, y usar las fundas para mantenerlos siempre óptimos. Antes de guardarlos, asegúrese de que están completamente secos. Nuestros materiales cumplen con los más altos estándares de calidad para uso al aire libre. Todos los tejidos son de secado rápido y fáciles de mantener.

DRY+ CONSTRUCCIÓN DE LOS COJINES

Los cojines Dry+ ofrecen una protección prolongada contra el clima. Los cojines están protegidos con un revestimiento muy impermeable con una resistencia al agua de nada menos que 10.000 mm. La tela está tratada para ser resistente a las manchas y al agua. La construcción del cojín Dry+ está disponible para todos los cojines marcados con el siguiente icono:



TEN FABRIC STYLES TO PLAY WITH

Each of the ten fabric styles in this catalog has a distinctive weaving structure that gives it a look and feel all its own. While any one of these fabrics is an ideal covering for cushions large or small, it's the opportunity to combine them that makes the DEDON collection so special. Play with textures. Mix the summerly lightness of COOL with the tweedy robustness of GLAN. Create subtle differences of shade by working with multiple fabric structures in the same color. The flexibility and creativity long associated with the finest indoor fabrics can now be enjoyed under the open skies.

ZEHN STOFFVARIATIONEN BIETEN ABWECHSLUNG

Jede der zehn Stoffvarianten in diesem Katalog hat ihre eigene unvergleichliche Webstruktur und damit einen ganz einzigartigen Look & Feel. Während sich jeder unserer Stoffe perfekt als Bezug für unsere Kissen eignet, egal ob klein oder groß, sind es insbesondere die vielfältigen Kombinationsmöglichkeiten der Stoffe untereinander, die die DEDON-Stoffkollektion so attraktiv machen. Spielen Sie mit den Texturen, etwa indem Sie die sommerliche Frische von COOL mit der Robustheit von GLAN kombinieren, die an Tweed-Stoffe erinnert. Schaffen Sie subtile Farbnuancen, indem Sie mit unterschiedlichen Strukturen in der gleichen Farbwelt arbeiten. Freuen Sie sich, dass Sie unter freiem Himmel ebenso abwechslungsreich und kreativ sein können, wie Sie es von den feinsten Indoor-Stoffen gewohnt sind.

DIEZ TIPOS DE TEJIDOS PARA COMBINAR

Cada uno de los diez tejidos que hay en este catálogo posee su propia estructura de tejido que lo diferencia y le confiere, por lo tanto, una apariencia y un tacto completamente únicos. Aunque cualquiera de los tejidos que se ofrecen sería un recubrimiento ideal tanto para cojines grandes como pequeños, la oportunidad sin precedentes de combinar múltiples tejidos es lo que confiere un gran atractivo a las colecciones de DEDON. Juegue con las texturas combinando la fresca veraniega de COOL con la robustez de GLAN que recuerda al tejido tweed. Cree sutiles matices trabajando con el mismo color en diferentes texturas. Disfrute de poder combinar y crear bajo cielo abierto de la misma manera que con los exquisitos tejidos de interior.

DRY+ CUSHION CONSTRUCTION

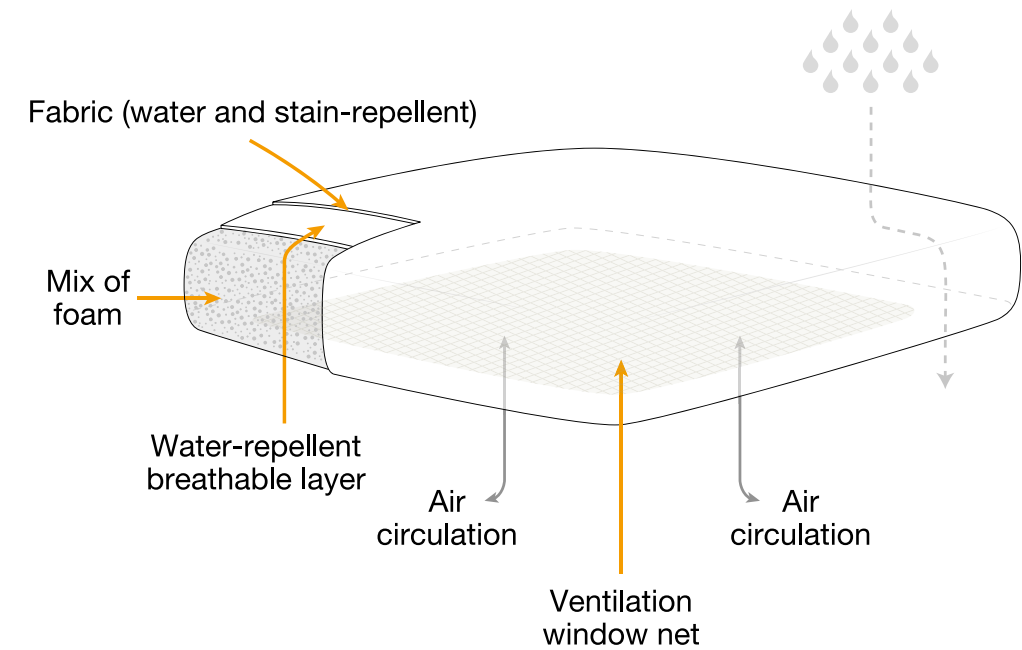

FABRICS

CATEGORY A — For all collections

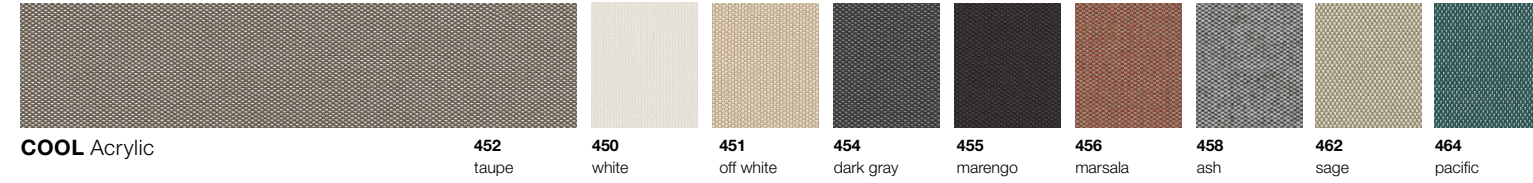

COOL Acrylic

452 taupe

450 white

451 off white

454 dark gray

455 marengo

456 marsala

458 ash

462 sage

464 pacific

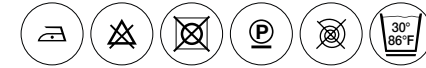

COOL A light, soft, summery fabric in a strié weave, COOL has a cotton-like touch and carries color beautifully.

CATEGORY B — For all collections

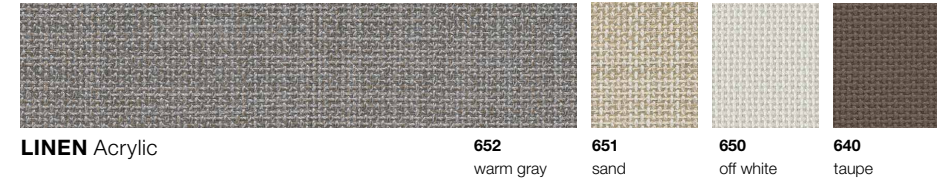

LINEN Acrylic

652 warm gray

651 sand

650 off white

640 taupe

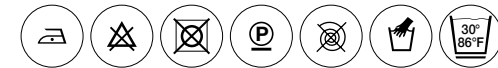

LINEN is an exceptionally comfortable fabric with a natural look and feel and a contemporary color palette.

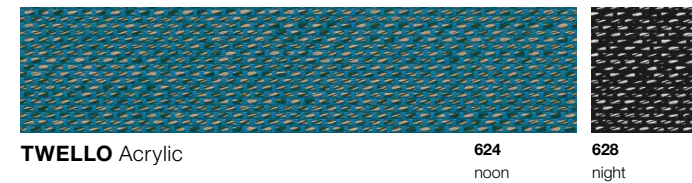

TWELLO Acrylic

624 noon

628 night

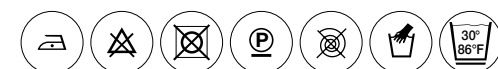

TWELLO A heavy-weight and robust fabric, TWELLO is woven with twisted yarns for a crisp, fresh and inviting touch.



TWIST Polypropylene

661 sand

660 beige

662 gray

663 terracotta

664 dark turquoise



TWIST Woven from fine twisted yarn, TWIST is a fresh, cool fabric with depth, structure and a lively color effect.

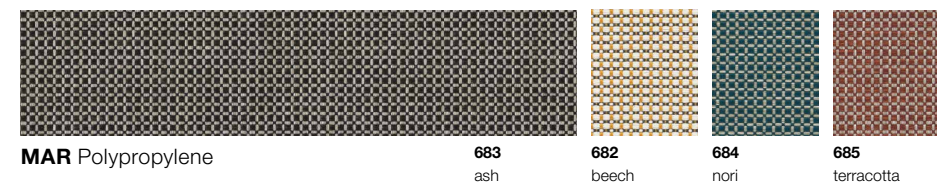

MAR Polypropylene

683 ash

682 beech

684 nori

685 terracotta



MAR Made of a blend of colored yarns in a basket weave, MAR is available in four colors, each one rich and complex.

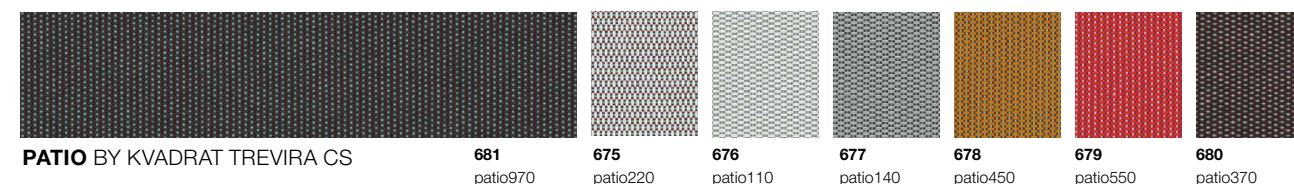

PATIO BY KVADRAT TREVIRA CS

681 patio970

675 patio220

676 patio110

677 patio140

678 patio450

679 patio550

680 patio370



PATIO BY KVADRAT With its subtle woven structure, PATIO by Kvadrat stands out for its softness and exceptional color vibrancy.

CATEGORY C — Fabrics are exclusive to specific collections

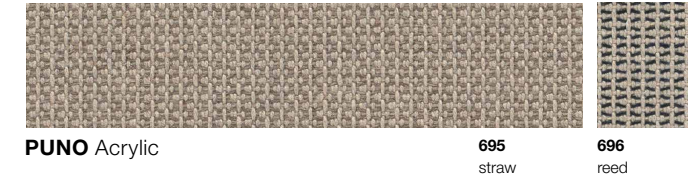

PUNO Acrylic

695 straw

696 reed



PUNO This thick and pleasing fabric gets its natural appearance through the use of 50-percent recycled post-industrial fibers, which convey both depth and richness of tone.

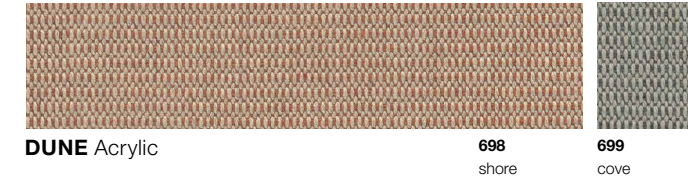

DUNE Acrylic

698 shore

699 cove



DUNE Soft and inviting, this fabric's chunky yarns are spun with 50-percent recycled post-industrial fibers in a mix of colors, ensuring each yarn is unique.

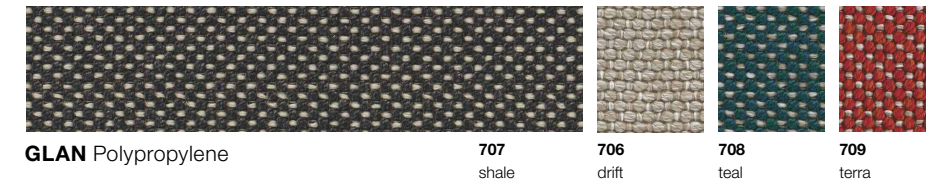

GLAN Polypropylene

707 shale

706 drift

708 teal

709 terra



GLAN A thick and hearty fabric, available in four colors, GLAN is distinguished by its inviting 3D woven structure.



DOTS Polypropylene

802 terra

800 gray



DOTS Available for deco cushions only, DOTS brings vibrant accents to any setting with its graphic, structured pattern.

ALL FABRICS ARE
QUICK-DRYING,
UV-RESISTANT AND
EASY TO MAINTAIN.

	DALA	SEALINE	BREA	TIBBO	BRIX	DECO CUSHIONS
GLAN	✓	✓	✓	✓	-	✓
PUNO	✓	✓	✓	✓	✓	✓
DUNE	✓	✓	✓	✓	✓	✓
DOTS	-	-	-	-	-	✓

QUALITY

EN BEST REASONS FOR CHOOSING DEDON

PRODUCED IN OUR OWN FACILITIES

The manufacturing of both DEDON Fiber in Germany and DEDON furniture in the Philippines take place in our own production facilities. This is unique in the outdoor furniture industry and ensures that fine craftsmanship is combined with innovative technology. DEDON's master weavers in the Philip-pines use ultra-strong fibers from our own DEDON production. For our contract partners, in-house production also means special opportunities for customization.

WORLD'S BEST FIBER

No matter if it's desert wind, salt water or frost, DEDON Fiber is tested against all weather conditions and for 10 years' UV resistance. Produced in Germany by our team of specialists, it is unrivaled for strength, color fastness and longevity. And because DEDON Fiber is developed entirely in-house, we are able to work with designers to create innovative solutions, including unique colors, textures and profiles.

THE RIGHT MATERIAL FOR EVERY SETTING

Specialists in outdoor living spaces of all kinds, DEDON selects the right material for every setting, from covered terraces to exposed poolsides to sandy beaches to wild nature. That's why, in addition to the world's best fiber, we work with highest-quality teak, aluminum, woven textiles, ceramics and upholstery, all manufactured with passion for excellence.

DE DIE BESTEN GRÜNDE FÜR DEDON

EIGENE PRODUKTION

Sowohl die Herstellung der DEDON Faser in Deutschland, als auch die Möbelproduktion auf den Philippinen findet in eigenen Produktionsstätten statt – dies ist einzigartig in der Outdoor-Möbel-Branche. Handwerks-kunst verbindet sich mit innovativer Technik – die DEDON Meisterflechter auf den Philippinen verwenden hochbelastbare Fasern aus der eigenen DEDON Produktion. Für unsere Objektpartner schafft die Produktion im eigenen Werk auch besondere Möglichkeiten für die Entwicklung individueller Farb- und Flechtvariationen.

DIE WELTBESTE FASER

Egal ob Wüstenwind, Salzwasser oder Frost – die DEDON-Faser ist gegen alle Witterungen und auf zehn Jahre UV-Beständigkeit getestet. Die in Deutschland von unserem Spezialistenteam hergestellte Faser ist in Sachen Festigkeit, Farbbeständigkeit und Langlebigkeit konkurrenzlos. Und weil wir bei DEDON unsere Fasern komplett im eigenen Hause entwickeln lassen, können wir in Zusammenarbeit mit unseren Designern innovative Lösungen entwickeln - einschließlich neuer Farben, Oberflächen und Faserprofile.

DIE RICHTIGEN MATERIALIEN FÜR JEDE UMGEBUNG

Als Spezialisten für alle Bereiche des Outdoor Living setzen wir bei DEDON auf die richtigen Materialien für jedes Umfeld, von der schattigen Terrasse bis zur prallen Sonne eines Poolbereichs, vom feinen Sandstrand bis zur wilden Naturlandschaft. Deshalb verwenden wir nicht nur die weltbeste Faser, sondern setzen auch ausschließlich Teakholz, Aluminium, Webtextilien, keramische Materialien und Polsterungen von höchster Qualität ein, die mit leidenschaftlichem Qualitätswillen gefertigt wurden.

ES LOS MEJORES ARGUMENTOS PARA DEDON

PRODUCCIÓN PROPIA

Tanto la fabricación de la fibra DEDON en Alemania como la producción de muebles en Filipinas se desarrollan en nuestros propios centros, una característica única dentro del sector del mobiliario de jardín. El trabajo artesanal se combina con la tecnología más innovadora: como resultado, los maestros tejedores de Filipinas emplean fibra de alta resistencia, fabricada por DEDON en régimen de producción propia.

LA MEJOR FIBRA DEL MUNDO

Da igual que se trate del viento del desierto, del agua de mar o de la escarcha: la fibra DEDON ha demostrado que es capaz de resistir todas estas agresiones y soportar sin alteraciones la acción de los rayos ultravioleta hasta 10 años. Fabricada en Alemania por nuestro equipo de especialistas, no tiene rival en lo que se refiere a fortaleza, solidez del color y durabilidad. Y dado que la fibra DEDON es se desarrolla completamente en casa, podemos trabajar conjuntamente con nuestros diseñadores para crear soluciones innovadoras, incluyendo colores, superficies y formas nuevas. Esto también se traduce en mayores oportunidades para que nuestros clientes contract ideen soluciones personalizadas.

MATERIALES CORRECTOS PARA TODOS LOS AMBIENTES

Siendo especialista en todo tipo de espacios al aire libre, DEDON selecciona el material correcto para cada ambiente: desde terrazas cubiertas a picanas con sol abrasador directo, desde playas arenosas hasta naturaleza salvaje. Por eso, además de la mejor fibra del mundo, trabajamos también con madera teca, aluminio, tejidos textiles, cerámicas y tapizados de la más alta calidad, todos fabricados calidad apasionada.

SUSTAINABILITY

It is DEDON's corporate philosophy to create furniture and accessories of such high quality that they need never be thrown away. Produced in our environmentally-sound facilities in Northern Germany, DEDON Fiber is 100% recyclable and free from pollutants and heavy metals. In addition DEDON incorporates recycled materials into our products whenever feasible.

DESIGN

DEDON collaborates with the world's top designers, from famous names to rising stars, on collections that consistently win the most prestigious design awards. Our in-house research and development department is able to work closely with each designer on solutions and innovations that make all the difference in terms of quality, function and style..

GLOBAL REACH

Distributed in more than 80 countries, with showrooms and sales office around the world, DEDON is a global company with a global mindset. We travel the world -- with furniture and our team -- as part of our ongoing Tour du Monde adventure, and no island or secret hideaway is too remote for us. Wherever our contract partners have projects to undertake, DEDON is available and ready to help.

NACHHALTIGKEIT

Es ist Teil der Unternehmensphilosophie von DEDON, dass wir Möbel und Accessoires von so hoher Qualität fertigen, dass sie ein Leben lang halten. Die DEDON-Faser, die in unserer umweltverträglich arbeitenden Produktionsstätte in Norddeutschland hergestellt wird, ist zu 100% recycelbar und frei von Schadstoffen und Schwermetallen. Darüber hinaus setzen wir bei der Herstellung unserer Produkte so oft wie möglich recycelte Materialien ein.

DESIGN

DEDON arbeitet mit Top-Designern aus aller Welt zusammen, vom Designer mit großem Namen bis zum aufstrebenden Jungdesigner. So entstehen Kollektionen, die immer wieder die prestigeträchtigsten Designpreise gewinnen. Dabei arbeitet unsere hauseigene Entwicklungsabteilung eng mit den Designern zusammen, um so Lösungen und Innovationen zu schaffen, die sich in Qualität, Funktionalität und Stil entschieden absetzen.

GLOBALE VERFÜGBARKEIT

Mit seinem in über 80 Ländern tätigen Vertrieb sowie Showrooms und Büros in aller Welt ist DEDON ein globale agierendes Unternehmen. Unsere „Tour-du-Monde“-Abenteuer führen uns – samt Möbeln und Team – kreuz und quer über den Planeten. Dabei ist uns keine Insel und kein versteckter Winkel zu entlegen. Wo auch immer unsere Objektpartner ihre Projekte abwickeln, ist DEDON zur Stelle und unterstützt sie gern.

SOSTENIBILIDAD

La filosofía corporativa de DEDON es fabricar muebles y accesorios de tan alta calidad que duren toda la vida. La fibra DEDON se fabrica en nuestras instalaciones seguras y respetuosas del medio ambiente del norte de Alemania. Es 100% reciclable y no contiene ningún tipo de sustancias tóxicas ni metales pesados. Además, siempre que sea factible, incorporamos materiales reciclados en nuestros productos.

DISEÑO

DEDON colabora con los mejores diseñadores del mundo, desde diseñadores reputados hasta diseñadores emergentes, para crear colecciones que siempre ganan los premios de diseño más prestigiosos. Nuestro departamento de investigación y desarrollo trabaja estrechamente con los diseñadores para crear soluciones e innovaciones que marquen la diferencia en términos de calidad, funcionalidad y estilo.

ALCANCE MUNDIAL

Distribuimos en más de 80 países diferentes, con oficinas de venta y tiendas repartidas por todo el mundo, lo cual hace que DEDON sea una empresa global con un enfoque mundial. Con nuestro "Tour du Monde" cruzamos constantemente el planeta de punta a punta, acompañados de nuestros muebles y equipos, de manera que no existe isla ni escondite que nos quede demasiado lejos. Allá donde nuestros clientes contract emprendan nuevos proyectos está DEDON disponible y preparado para ayudarles.



QUALITY IS IN OUR DNA

DEDON GmbH

Zeppelinstrasse 22
21337 Lüneburg/Germany
Tel. +49 41 31/22 44 70
Fax +49 41 31/22 44 7 630
info@dedon.de

DEDON Inc.

657-C Brigham Road
Greensboro, NC 27409
877-693-3366
office@dedon.us

www.dedon.de